



KAYTUS Server NF5180M6 White Paper

Document Version: V1.0
Release Date: August 28, 2023

Copyright © 2023 KAYTUS SINGAPORE PTE. LTD. All rights reserved.

No part of this document may be reproduced or transmitted in any form or by any means without prior written consent.

Technical Support

Global Service Hotline: (+1) 844-860-0011/(+1) 325-880-0011
Address: 22 Sin Ming Lane, #06-76, Midview City,
Singapore 573969
KAYTUS SINGAPORE PTE. LTD.
Website: <https://www.kaytus.com>
Email: servicesupport@kaytus.com

Environmental Protection

Please dispose of product packaging by recycling at a local recycling center for a greener planet.

Trademarks

All the trademarks or registered trademarks mentioned herein may be the property of their respective holders. This document does not mark any product or brand with symbol (® or ™).

Security Statement

We are intensely focused on server product safety and have placed a high priority on this. For a better understanding of our server products, carefully read through the following security risk statements.

- When servers are to be repurposed or retired, we recommend that you restore their firmware factory settings, delete information and clear logs from BIOS and BMC to protect data privacy. Meanwhile, we recommend you to wipe the drive data thoroughly and securely with trusted erasing tools. You can use InManage Server Provisioning. Contact us for specific server models to which InManage Server Provisioning is applicable.
- For server open source software statements, please contact us.
- Some interfaces and commands for production, assembly and return-to-depot, and advanced commands for locating faults, if used improperly, may cause equipment abnormality or business interruption. This is not described herein. Please contact us for such information.
- External ports of our servers do not use private protocols for communication.
- Our products will not initiatively obtain or use your personal data. Only when you consent to use certain functions or services, some personal data such as IP address and email address for alerts may be obtained or used during business operation or fault location. We have implemented necessary measures on product functions to ensure personal data security throughout the data lifecycle, including but not limited to data collection, storage, use, transmission, and destruction. Meanwhile, you are obligated to establish necessary user privacy policies in accordance with applicable national/regional laws and regulations to fully protect user personal data.
- Committed to product data security, we have implemented necessary measures on product functions to protect system operation and security data throughout its lifecycle in strict accordance with relevant laws, regulations and supervision

requirements. As the owner of system operation and security data, you are obligated to establish necessary data security policies and take adequate measures in accordance with applicable national/regional laws and regulations to fully protect system operation and security data.

- We will remain committed to the safety of our products and solutions to achieve better customer satisfaction. We have established emergency response procedures and action plans for security vulnerabilities, so that product safety issues can be dealt with in a timely manner. Please contact us for any safety problems found or necessary support on security vulnerabilities when using our products.

Disclaimer

The purchased products, services and features shall be bound by the contract made between the customer and us. All or part of the products, services and features described herein may not be within your purchase or usage scope. Unless otherwise agreed in the contract, we make no express or implied statement or warranty on the contents herein. Images provided herein are for reference only and may contain information or features that do not apply to your purchased model. This document is only used as a guide. We shall not be liable for any damage, including but not limited to loss of profits, loss of information, interruption of business, personal injury, or any consequential damage incurred before, during, or after the use of our products. We assume you have sufficient knowledge of servers and are well trained in protecting yourself from personal injury or preventing product damages during operation and maintenance. The information in this document is subject to change without notice. We shall not be liable for technical or editorial errors or omissions contained in this document.

Abstract





This document describes the NF5180M6 server's appearance, features, performance parameters, and software and hardware compatibility, providing in-depth information of NF5180M6.

Intended Audience

This document is intended for pre-sales engineers.

Symbol Conventions

The symbols that may be found in this document are defined as follows.

Symbol	Description
 DANGER	A potential for serious injury, or even death if not properly handled
 WARNING	A potential for minor or moderate injury if not properly handled
 CAUTION	A potential loss of data or damage to equipment if not properly handled
 IMPORTANT	Operations or information that requires special attention to ensure successful installation or configuration
 NOTE	Supplementary description of document information

Revision History

Version	Date	Description of Changes
V1.0	2023/08/28	Initial release

Table of Contents

1	Product Overview	1
2	Features	3
2.1	Scalability and Performance	3
2.2	Availability and Serviceability	4
2.3	Manageability and Security.....	4
2.4	Energy Efficiency	5
3	System Parts Breakdown	6
4	System Logical Diagram	7
5	Hardware Description.....	8
5.1	Front Panel.....	8
5.1.1	Appearance	8
5.1.2	LEDs and Buttons	10
5.1.3	Ports	15
5.2	Rear Panel.....	17
5.2.1	Appearance	17
5.2.2	LEDs and Buttons	18
5.2.3	Ports	19
5.3	Processors.....	21
5.4	Memory	22
5.4.1	DDR4 DIMMs	22
5.4.2	PMems	30
5.5	Storage	36
5.5.1	Drive Configurations	36
5.5.2	Drive Numbering	39
5.5.3	Drive LEDs	43
5.5.4	RAID Controller Cards	44
5.6	Network	44
5.7	I/O Expansion	44
5.7.1	PCIe Cards.....	44
5.7.2	PCIe Slots	45
5.7.3	PCIe Slot Description	47
5.8	PSUs	48
5.9	Fans	48
5.10	LCD Module (Optional)	49
5.10.1	Function.....	49
5.10.2	Interface	51

5.11	Boards.....	52
5.11.1	Motherboard	52
5.11.2	Drive Backplanes	53
6	Product Specifications	60
6.1	Technical Specifications	60
6.2	Environmental Specifications.....	61
6.3	Physical Specifications	64
7	Operating System and Hardware Compatibility	65
7.1	Supported Operating Systems	65
7.2	Hardware Compatibility	66
7.2.1	CPU Specifications	66
7.2.2	Memory Specifications.....	67
7.2.3	Drive Specifications	67
7.2.4	SAS/RAID Controller Card Specifications	68
7.2.5	NIC Specifications	69
7.2.6	HBA and HCA Card Specifications	70
7.2.7	Graphics Card Specifications	70
7.2.8	PSU Specifications	71
8	Regulatory Information	73
8.1	Safety.....	73
8.1.1	General.....	73
8.1.2	Personal Safety.....	73
8.1.3	Equipment Safety	75
8.1.4	Transportation Precautions	76
8.1.5	Manual Handling Weight Limits.....	76
9	Limited Warranty.....	77
9.1	Warranty Service	77
9.1.1	Remote Technical Support.....	77
9.1.2	RMA Service	78
9.1.3	ARMA Service	78
9.1.4	9 × 5 × NBD Onsite Service	78
9.1.5	24 × 7 × 4 Onsite Service	79
9.2	Our Service SLA	79
9.3	Warranty Exclusions	79
10	System Management.....	81
10.1	Intelligent Management System ISBMC	81
10.2	InManage	83
10.3	InManage Tools.....	87

11	Certifications	88
12	Appendix A.....	89
12.1	Operating Temperature Specification Restrictions	89
12.2	Model.....	90
12.3	RAS Features	90
12.4	Sensor List.....	91
13	Appendix B Acronyms and Abbreviations	95
13.1	A - E.....	95
13.2	F - J.....	96
13.3	K - O	97
13.4	P - T.....	98
13.5	U - Z	99

1 Product Overview

The NF5180M6 is a 1U 2-socket high-density computing rack server. Powered by Intel Xeon Scalable processors on the Intel Whitley platform, it maximizes the performance, density, and scalability of the server. It is adaptable for computing-intensive workloads such as virtualization, high-performance computing, and online computing. Hence, it can meet the deployment requirements of high-density data centers.

Figure 1-1 NF5180M6 - 4 × 3.5-inch Drive + 2 × E1.S SSD + 2 × M.2 SSD Configuration

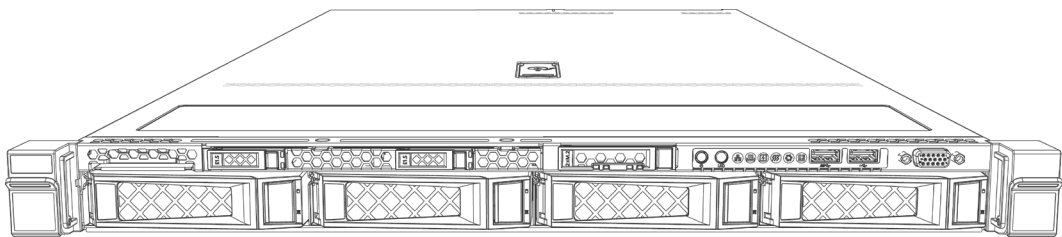

Figure 1-2 NF5180M6 - 4 × 3.5-inch Drive + 4 × 2.5-inch Drive Configuration

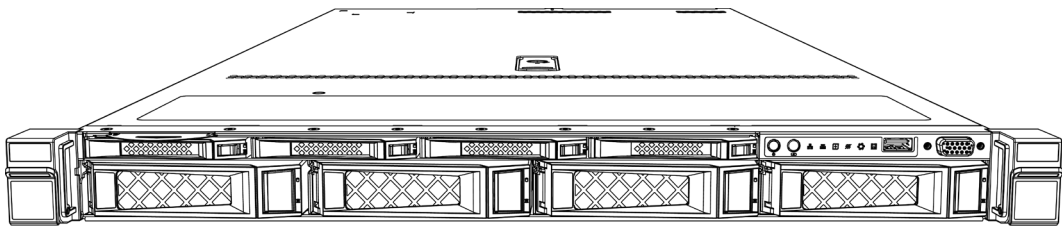

Figure 1-3 NF5180M6 - 10 × 2.5-inch Drive Configuration

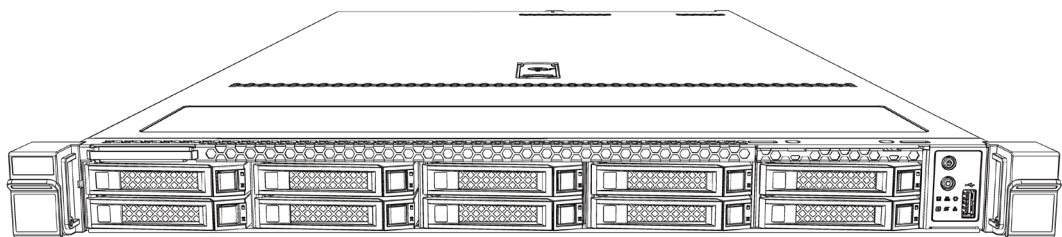

Figure 1-4 NF5180M6 - 8 × 2.5-inch Drive + 2 × E1.S SSD + 2 × M.2 SSD Configuration

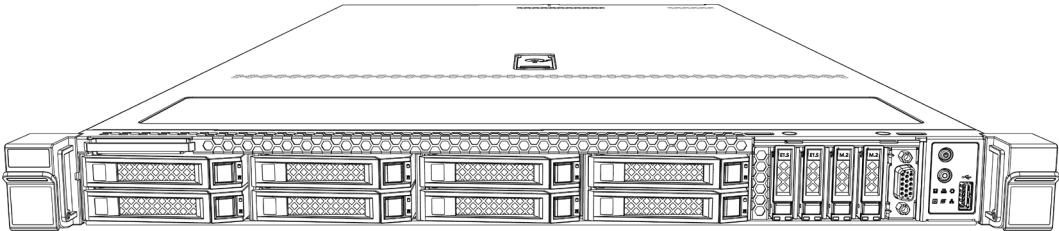

Figure 1-5 NF5180M6 - 12 × 2.5-inch Drive Configuration

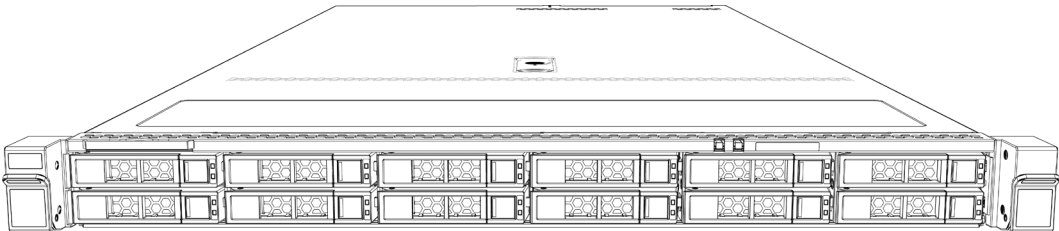

Figure 1-6 NF5180M6 - 32 × E1.S SSD Configuration

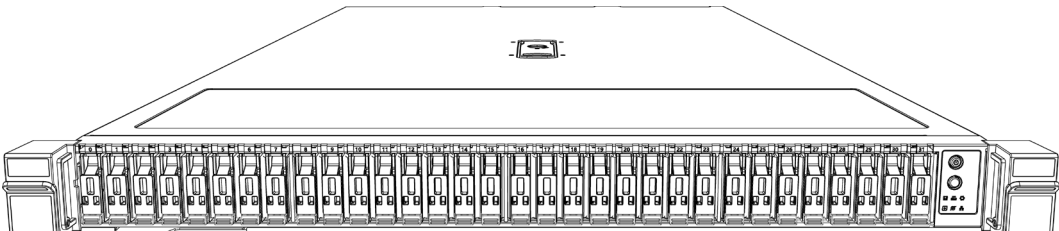
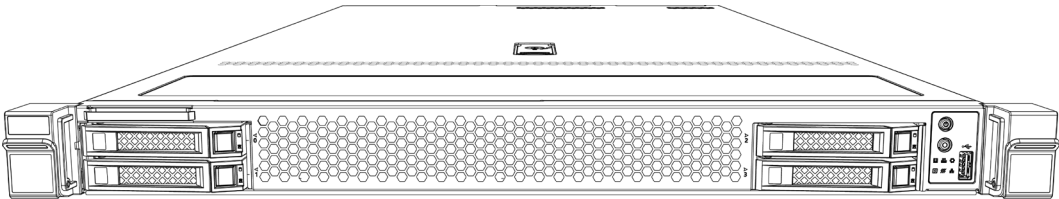

Figure 1-7 NF5180M6 - EVAC Heatsink Configuration



2 Features

2.1 Scalability and Performance

- Scalability
 - Up to 12 front 2.5-inch SAS/SATA/NVMe drives + 2 rear 2.5-inch SAS/SATA drives or up to 32 front E1.S SSDs.
 - 1 optional OCP 3.0 card of 1/10/25/40/100 Gb, delivering more flexible network architectures.
 - Up to 3 standard PCIe 4.0 x16 expansion cards of diverse form factors, meeting different customer needs.
 - Optional front M.2 SSDs and E1.S SSDs, satisfying diverse storage demands.
 - 2 front SATA M.2 SSDs or 2 internal PCIe x4 M.2 SSDs.
- Performance
 - Up to two 3rd Gen Intel Xeon Scalable processors with up to 40 cores per processor, a base frequency of up to 3.6 GHz, a TDP of up to 270 W and 3 UPI links per processor at up to 11.2 GT/s, bringing an overall computing performance increase by 46%.
 - Up to 32 DDR4 ECC DIMMs (3,200 MT/s, RDIMM/LRDIMM/NVDIMM, up to 128 GB per memory module) with the total memory capacity up to 10 TB when used with BPS, delivering superior speeds and high availability.
 - Supports Intel Optane PMem 200 series of up to 512 GB per memory module and 3,200 MHz, ensuring memory data integrity in case of power failure without compromising on the memory capacity and bandwidth.
 - Up to 12 hot-swap all-flash NVMe SSDs, providing an IOPS ten times that of high-end enterprise-grade SATA SSDs and a 20% storage capacity increase over the M5 counterpart.
 - Up to 32 hot-swap all-flash E1.S SSDs, delivering high IOPS like traditional NVMe SSDs, massive storage in 1U space thanks to its small form factor and 3.2 times overall IOPS performance.

2.2 Availability and Serviceability

- Based on humanization design, the server allows tool-less maintenance. The enhanced and optimized structural parts enable quick removal/installation, greatly reducing O&M time.
- Our unique intelligent control technology combined with the cutting-edge air-cooling technology creates an optimum working environment to ensure the stable running of the server.
- The server supports hot-swap storage drives and 3 RAID controller cards with RAID levels 0, 1, 10, 5, 6, 60 and 1E, RAID cache and data protection enabled by the super-capacitor in case of power failures.
- With the latest BMC technologies, the UID LED on the front panel enables technicians to identify the failed system, and the BMC Web GUI and LEDs for fault diagnosis can quickly lead technicians to failed (or failing) components, simplifying maintenance, speeding up troubleshooting, and enhancing system availability.
- The BMC can monitor system parameters and send alerts in advance, so that technicians can take appropriate measures in time to ensure the stable running of the server and reduce the downtime.

For documentation of the NF5180M6 system, such as product marketing materials, user manuals, product drivers, firmware, and product certifications, visit our website.

2.3 Manageability and Security

- Manageability
 - Supports ISBMC, a remote server management system.
 - ISBMC supports such mainstream management specifications in the industry as IPMI 2.0 and Redfish 1.8.
 - ISBMC improves operational reliability.
 - ISBMC features easy serviceability for different business scenarios.
 - ISBMC provides comprehensive and accurate fault diagnosis capabilities.
 - ISBMC offers industry-leading security reinforcement capabilities.
 - The intelligent management software InManage allows centralized management of the server and full lifecycle management covering part-level asset management, intelligent monitoring and alerting, automatic inspection, fault diagnosis and reporting, energy consumption management, and firmware update/configuration.

- The InManage Boot system enables rapid server initialization and supports batch RAID configuration and OS deployment.
- Security
 - In terms of hardware design, the motherboard and backplanes are equipped with overcurrent and overvoltage protection functions, and the onboard connectors and cables are designed to be fool-proof. Hence, the server is capable of protecting itself against overload impacts
 - As to structural security, the server is designed with a hood latch on the top cover and a lock on the front bezel. Its intrusion switch sends a real-time alert upon an intrusion into the chassis.
 - As for hardware ports, all physical I/O ports are clearly defined. An access control mechanism is established for the service ports to prevent malicious operations by unauthorized personnel.
 - Regarding firmware security, images are signed with secure encryption algorithms before release, and the signature must be validated before firmware update, ensuring the integrity and legitimacy of the firmware.
 - The intelligent management system ISBMC provides various security features such as identification and authentication, authorization and access control, Web GUI security configuration, and log audit, offering industry-leading security reinforcement capabilities.
 - The optional TPM/TCM ensures data security and secure boot of the server.

2.4 Energy Efficiency

- Equipped with 80 Plus Platinum level PSUs (550 to 1,300 W) with the power efficiency up to 94% at a load of 50%.
- Offers 1+1 redundant PSUs with AC/DC input support for improved system reliability.
- Features high-efficiency single-board voltage regulator down (VRD) solutions, reducing DC-DC conversion loss.
- Supports intelligent fan speed control and intelligent CPU frequency scaling, conserving energy.
- Adopts ultimate heat dissipation design and optimized fan models, and honeycomb layer waveguide boards for improved HDD RV (Rotational Vibration) performance.
- With the introduction of the EVAC solution, the 1U space now accommodates two 270 W CPUs, enabling worry-free deployment in high-density server rooms.

3 System Parts Breakdown

Figure 3-1 Exploded View (Demonstrated with 4 × 3.5-inch Drive Configuration)

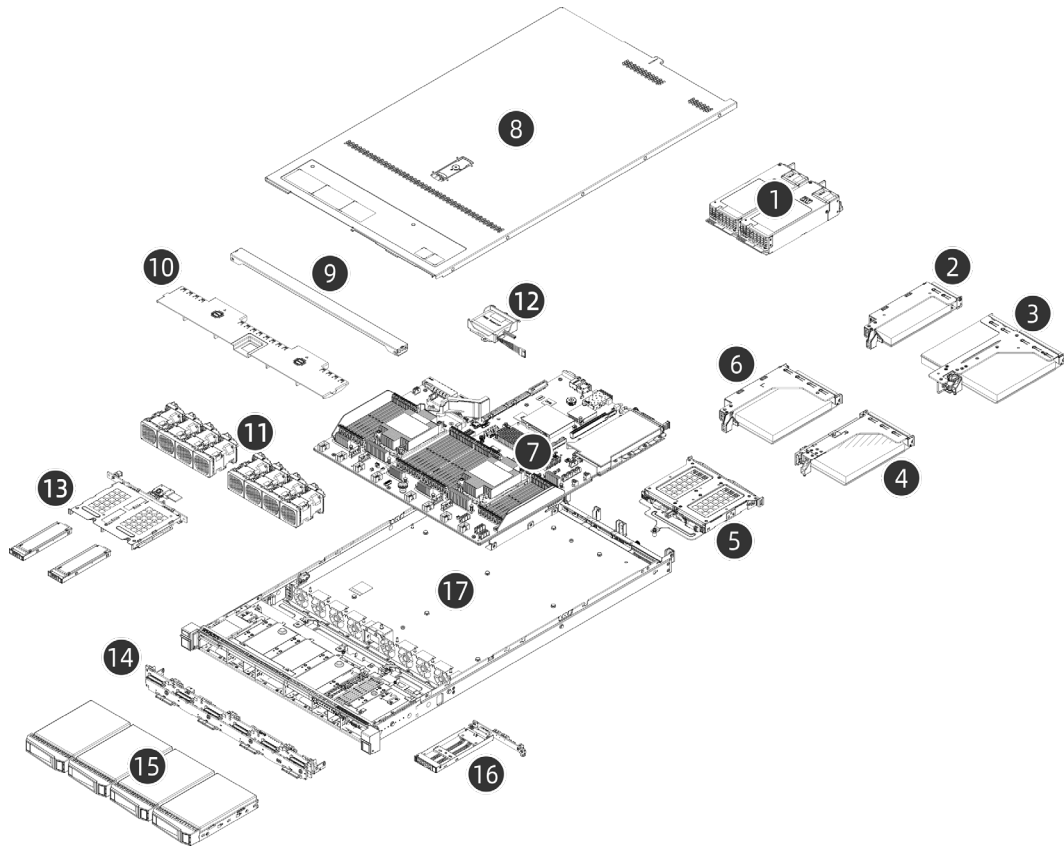

Item	Feature	Item	Feature
1	PSU × 2	2	LP PCIe Riser-Card Assembly
3	Butterfly PCIe Riser-Card Assembly	4	Right FHHL PCIe Riser-Card Assembly (view the server from the front)
5	Rear 2.5-inch Drive × 2	6	Left FHHL PCIe Riser-Card Assembly (view the server from the front)
7	Motherboard	8	Top Cover
9	Reinforcement Crossbar	10	Air Duct
11	Fan Module × 8	12	Super-Capacitor Module
13	E1.S SSD × 2	14	4 × 3.5-inch Drive Backplane
15	3.5-inch Drive × 4	16	M.2 SSD Module (with 2 M.2 SSDs)
17	3.5-inch Drive Chassis		

4 System Logical Diagram

Figure 4-1 System Logical Diagram

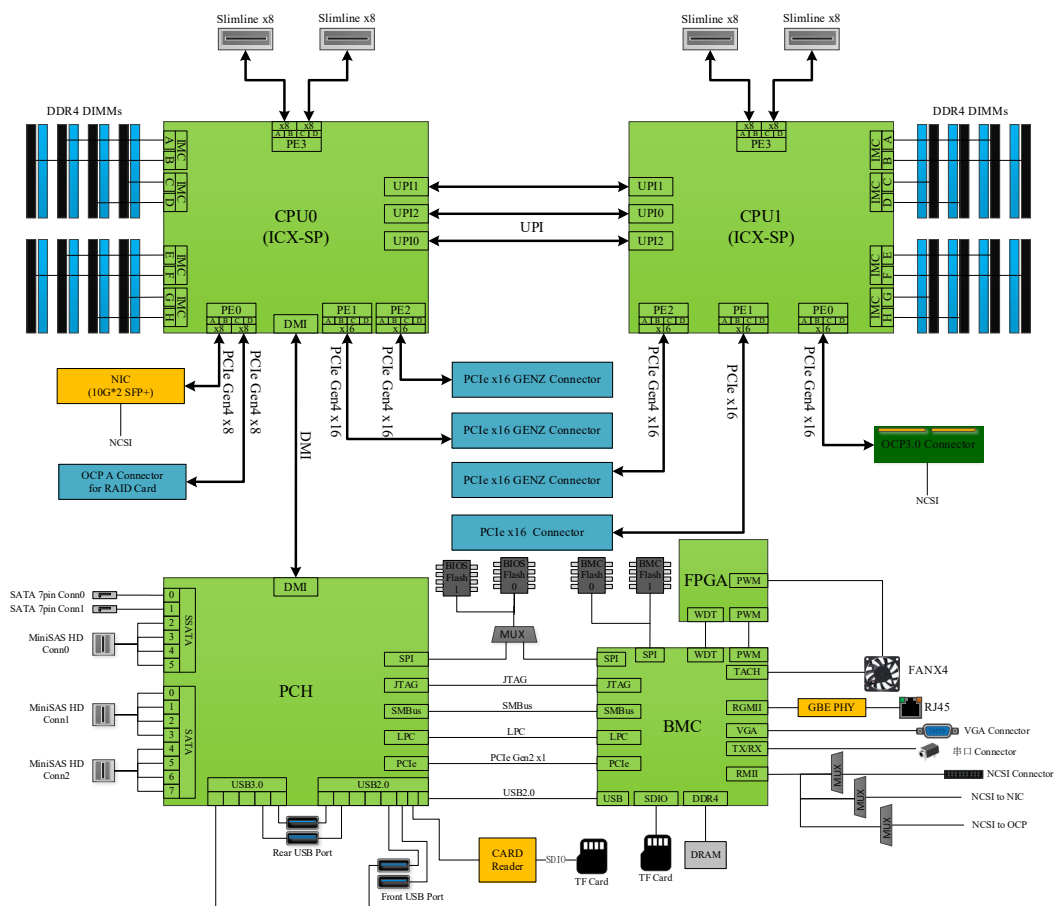

- The NF5180M6 supports up to 2 Intel Xeon Scalable processors and up to 32 DDR4 DIMMs.
- Processors are interconnected through 3 UPI links at up to 11.2 GT/s.
- Processors are connected to the 3 PCIe slots on the motherboard through PCIe buses, supporting up to 2 PCIe 4.0 x16 FHHL cards or 2 PCIe 4.0 x16 HHHL cards + 1 PCIe 4.0 x16 FHHL card.
- The mezz RAID controller card or the 2 NVMe M.2 SSDs are connected to CPU0 through the PCIe bus. With SAS signal cables, the mezz RAID controller card connects to different drive backplanes, enabling different storage drives specifications.

5 Hardware Description

5.1 Front Panel

5.1.1 Appearance

Figure 5-1 Front View of 4 × 3.5-inch Drive + 2 × E1.S SSD + 2 × M.2 SSD Configuration

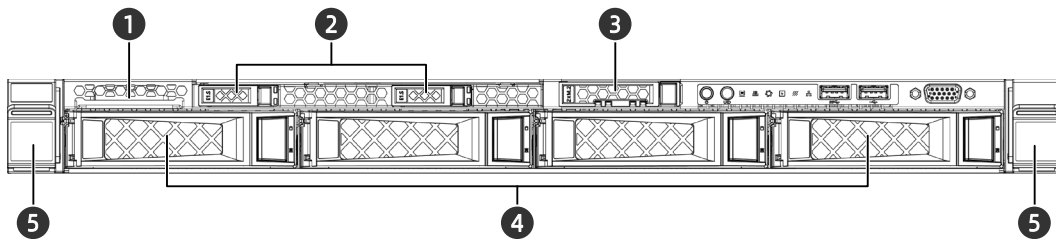

Item	Feature	Item	Feature
1	Serial Label Pull Tag (including SN and drive numbers)	2	E1.S SSD Bay × 2
3	M.2 SSD Bay (with 2 M.2 SSDs)	4	3.5-inch Drive Bay × 4
5	Ear Latch × 2		

Figure 5-2 Front View of 4 × 3.5-inch Drive + 4 × 2.5-inch Drive Configuration

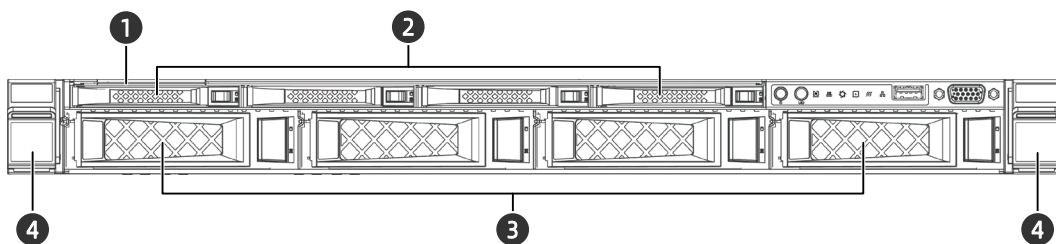

Item	Feature	Item	Feature
1	Serial Label Pull Tag (including SN and drive numbers)	2	2.5-inch Drive Bay × 4
3	3.5-inch Drive Bay × 4	4	Ear Latch × 2

● Figure 5-3 Front View of 10 × 2.5-inch Drive Configuration

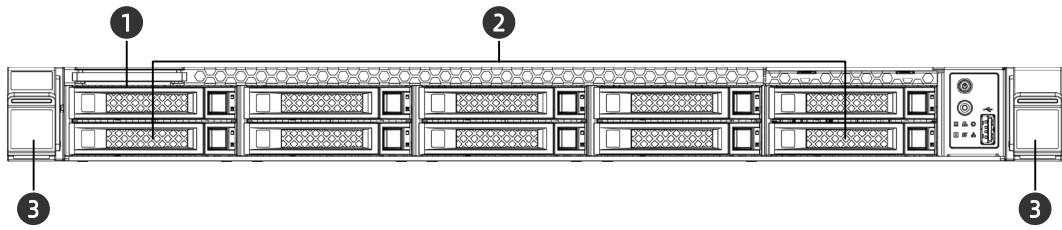

Item	Feature	Item	Feature
1	Serial Label Pull Tag (including SN and drive numbers)	2	2.5-inch Drive Bay × 10
3	Ear Latch × 2		

Figure 5-4 Front View of 12 × 2.5-inch Drive Configuration

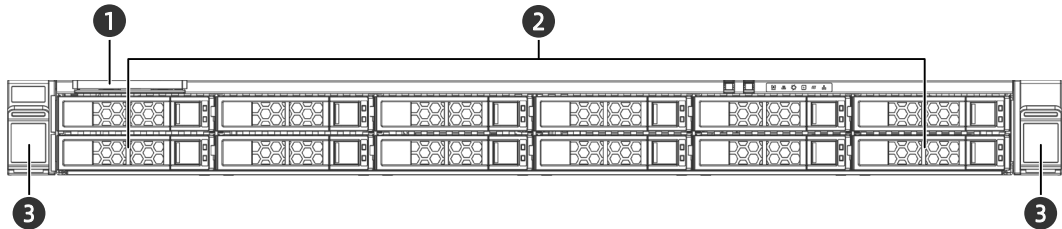

Item	Feature	Item	Feature
1	Serial Label Pull Tag (including SN and drive numbers)	2	2.5-inch Drive Bay × 12
3	Ear Latch × 2		

Figure 5-5 Front View of 8 × 2.5-inch Drive + 2 × E1.S SSD + 2 × M.2 SSD Configuration

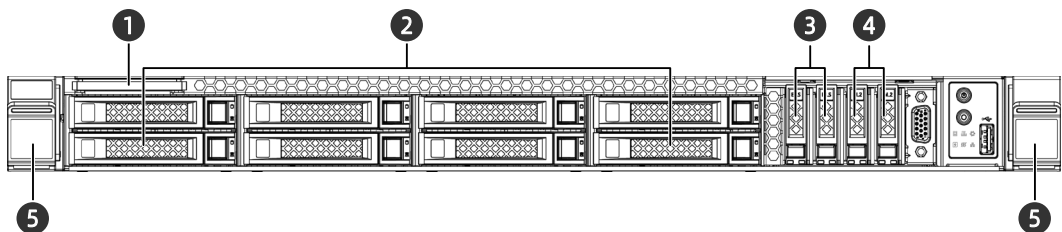

Item	Feature	Item	Feature
1	Serial Label Pull Tag (including SN and drive numbers)	2	2.5-inch Drive Bay × 8
3	E1.S SSD Bay × 2	4	M.2 SSD Bay × 2
5	Ear Latch × 2		

Figure 5-6 Front View of 32 × E1.S SSD Configuration

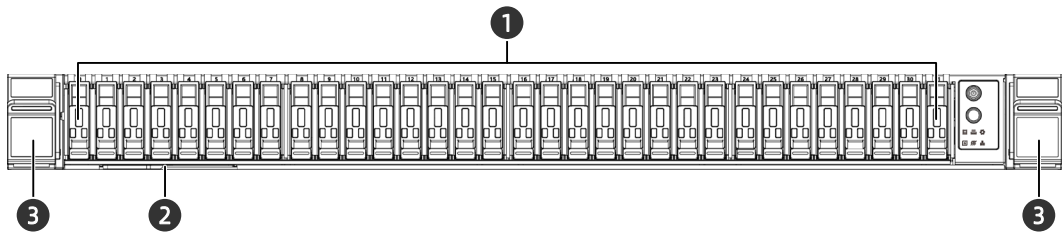

Item	Feature	Item	Feature
1	E1.S SSD Bay × 32	2	Serial Label Pull Tag (including SN and drive numbers)
3	Ear Latch × 2		

Figure 5-7 Front View of EVAC Heatsink Configuration

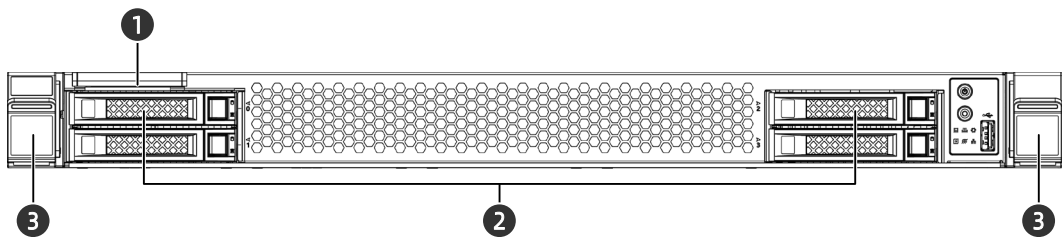

Item	Feature	Item	Feature
1	Serial Label Pull Tag (including SN and drive numbers)	2	2.5-inch Drive Bay × 4
3	Ear Latch × 2		

5.1.2 LEDs and Buttons

Figure 5-8 Front Panel LEDs and Buttons of 4 × 3.5-inch Drive + 2 × E1.S SSD + 2 × M.2 SSD Configuration

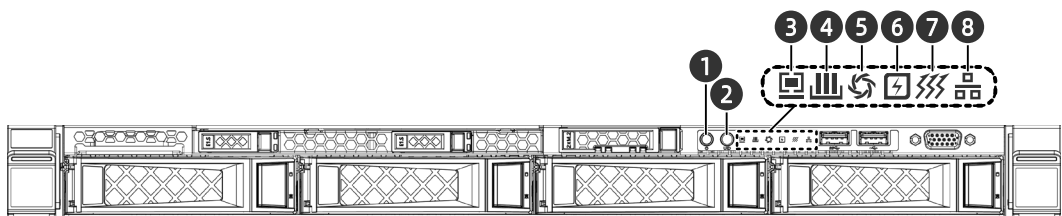

Item	Feature	Item	Feature
1	Power Button and LED	2	UID/BMC RST Button and LED
3	System Status LED	4	Memory Status LED

Item	Feature	Item	Feature
5	Fan Status LED	6	Power Status LED
7	System Overheat LED	8	Network Status LED

Figure 5-9 Front Panel LEDs and Buttons of 4 × 3.5-inch Drive + 4 × 2.5-inch Drive Configuration

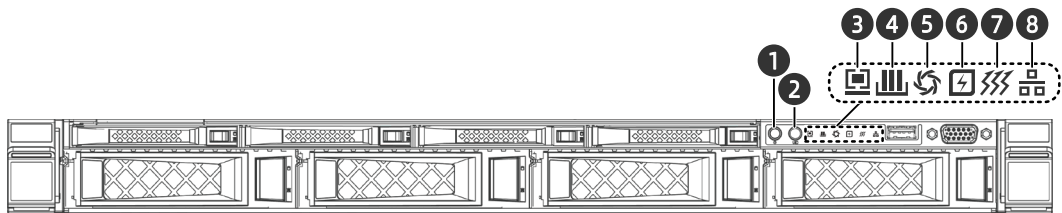

Item	Feature	Item	Feature
1	Power Button and LED	2	UID/BMC RST Button and LED
3	System Status LED	4	Memory Status LED
5	Fan Status LED	6	Power Status LED
7	System Overheat LED	8	Network Status LED

Figure 5-10 Front Panel LEDs and Buttons of 10 × 2.5-inch Drive Configuration

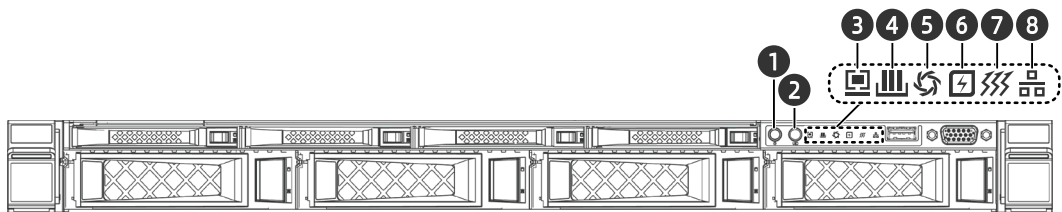

Item	Feature	Item	Feature
1	Power Button and LED	2	UID/BMC RST Button and LED
3	System Status LED	4	Memory Status LED
5	Power Status LED	6	Network Status LED
7	System Overheat LED	8	Fan Status LED

Figure 5-11 Front Panel LEDs and Buttons of 12 × 2.5-inch Drive Configuration

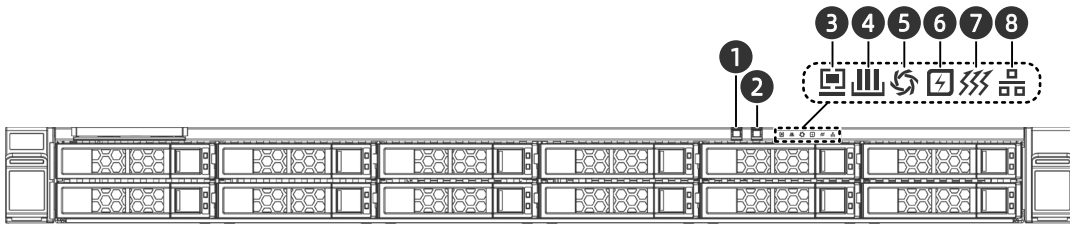

Item	Feature	Item	Feature
1	Power Button and LED	2	UID/BMC RST Button and LED
3	System Status LED	4	Memory Status LED
5	Fan Status LED	6	Power Status LED
7	System Overheat LED	8	Network Status LED

Figure 5-12 Front Panel LEDs and Buttons of 8 × 2.5-inch Drive + 2 × E1.S SSD + 2 × M.2 SSD Configuration

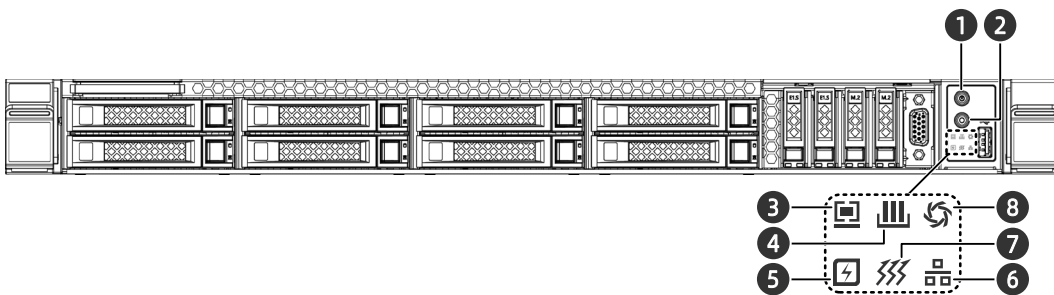

Item	Feature	Item	Feature
1	Power Button and LED	2	UID/BMC RST Button and LED
3	System Status LED	4	Memory Status LED
5	Power Status LED	6	Network Status LED
7	System Overheat LED	8	Fan Status LED

Figure 5-13 Front Panel LEDs and Buttons of 32 × E1.5 SSD Configuration

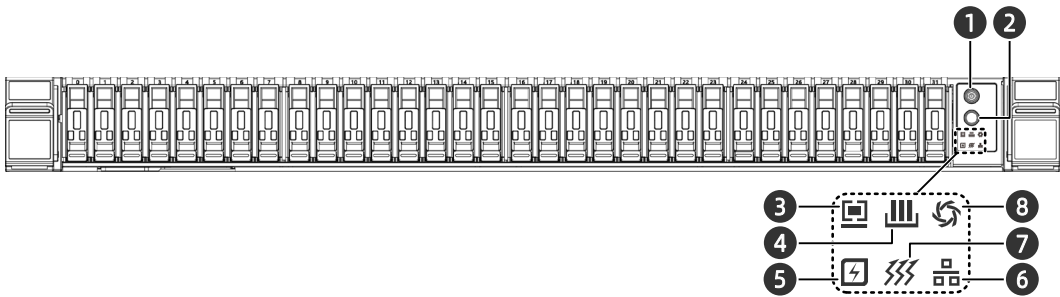

Item	Feature	Item	Feature
1	Power Button and LED	2	UID/BMC RST Button and LED
3	System Status LED	4	Memory Status LED
5	Power Status LED	6	Network Status LED
7	System Overheat LED	8	Fan Status LED



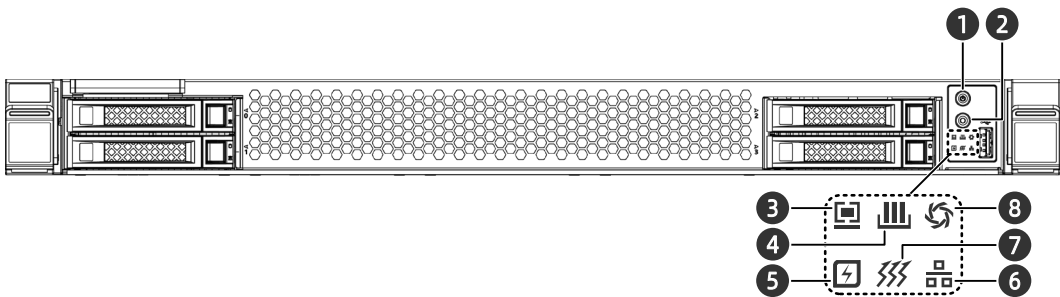

Figure 5-14 Front Panel LEDs and Buttons of EVAC Heatsink Configuration



Item	Feature	Item	Feature
1	Power Button and LED	2	UID/BMC RST Button and LED
3	System Status LED	4	Memory Status LED
5	Power Status LED	6	Network Status LED
7	System Overheat LED	8	Fan Status LED

1. LED and Button Description

Table 5-1 Front Panel LED and Button Description

Icon	LED & Button	Description
	Power Button and LED	<p>Power LED:</p> <ul style="list-style-type: none"> • Off = No power • Solid green = Power-on state • Solid orange = Standby state <p>Power button:</p> <ul style="list-style-type: none"> • Long press 6 seconds to force a shutdown from the power-on state. <p>Notes:</p> <ul style="list-style-type: none"> • Follow the prompt under the OS to shut down the OS. • Short press the power button to power on the system in standby state.
	UID/BMC RST Button and LED	<p>The UID LED is used to identify the device to be operated:</p> <ul style="list-style-type: none"> • Off = System unit not identified • Solid blue = System unit identified <p>Notes:</p> <ul style="list-style-type: none"> • The UID LED turns on when activated by the UID button or via ISBMC remotely. • Long press the UID button for over 6 seconds to reset the BMC.
	Memory Status LED	<ul style="list-style-type: none"> • Off = Normal • Flashing red (1 Hz) = A warning occurs • Solid red = A failure occurs
	System Status LED	<ul style="list-style-type: none"> • Off = Normal • Flashing red (1 Hz) = A warning occurs • Solid red = A failure occurs
	Power Status LED	<ul style="list-style-type: none"> • Off = Normal • Flashing red (1 Hz) = A warning occurs

Icon	LED & Button	Description
		<ul style="list-style-type: none"> Solid red = A failure occurs
	System Overheat LED	<ul style="list-style-type: none"> Off = Normal Flashing red (1 Hz) = A warning occurs Solid red = A failure occurs
	Fan Status LED	<ul style="list-style-type: none"> Off = Normal Flashing red (1 Hz) = A warning occurs Solid red = A failure occurs
	Network Status LED	<ul style="list-style-type: none"> Off = No network connection or abnormal Flashing green = Data being transmitted <p>Note: It only indicates the working status of LOM.</p>

5.1.3 Ports

Figure 5-15 Front Panel Ports of 4 × 3.5-inch Drive + 2 × E1.S SSD + 2 × M.2 SSD Configuration

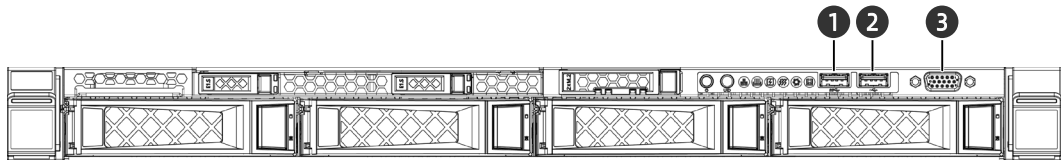

Item	Feature	Item	Feature
1	USB 3.0 Port	2	USB 2.0/LCD Port
3	VGA Port		

Figure 5-16 Front Panel Ports of 4 × 3.5-inch Drive + 4 × 2.5-inch Drive Configuration

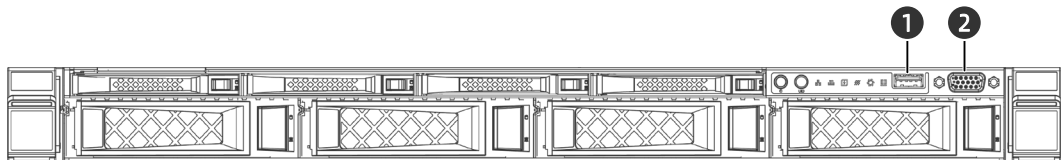

Item	Feature	Item	Feature
1	USB 3.0 Port	2	VGA Port

Figure 5-17 Front Panel Ports of 10 × 2.5-inch Drive Configuration

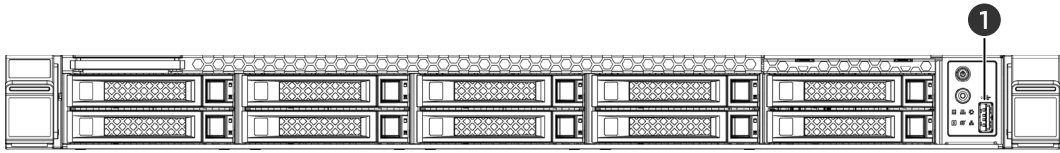

Item	Feature	Item	Feature
1	USB 2.0/LCD Port		

Figure 5-18 Front Panel Ports of 8 × 2.5-inch Drive + 2 × E1.S SSD + 2 × M.2 SSD Configuration

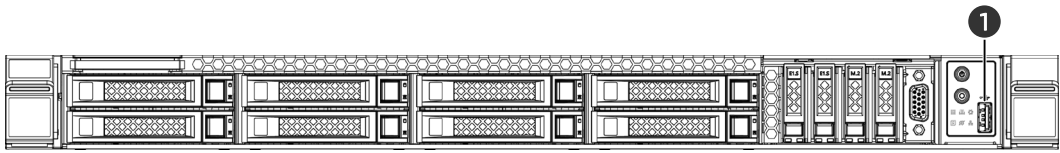

Item	Feature	Item	Feature
1	USB 2.0/LCD Port		

Figure 5-19 Front Panel Ports of EVAC Heatsink Configuration

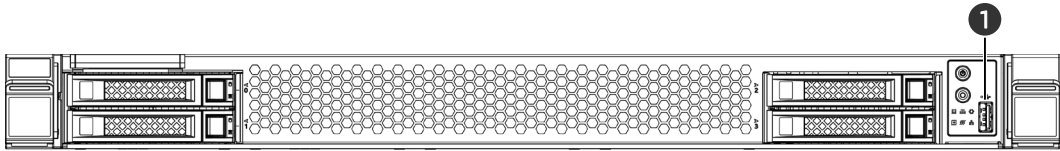

Item	Feature	Item	Feature
1	USB 2.0/LCD Port		

1. Port Description

Table 5-2 Front Panel Port Description

Feature	Type	Quantity	Description
VGA Port	DB15	1	Enables you to connect a display terminal, for example, a monitor or KVM to the system.
USB 3.0 Port	USB 3.0	1	Enables you to connect a USB 3.0 device to the system. Note:

Feature	Type	Quantity	Description
			<ul style="list-style-type: none"> Make sure the USB device is in good condition or it may cause the server to work abnormally.
USB 2.0/LCD Port	USB 2.0	1	<ul style="list-style-type: none"> The USB 2.0 port enables you to connect a USB 2.0 device to the system. <p>Note:</p> <ul style="list-style-type: none"> Make sure the USB device is in good condition or it may cause the server to work abnormally. The LCD port enables you to connect an LCD module to the system.

5.2 Rear Panel

5.2.1 Appearance

Figure 5-20 Rear View 1

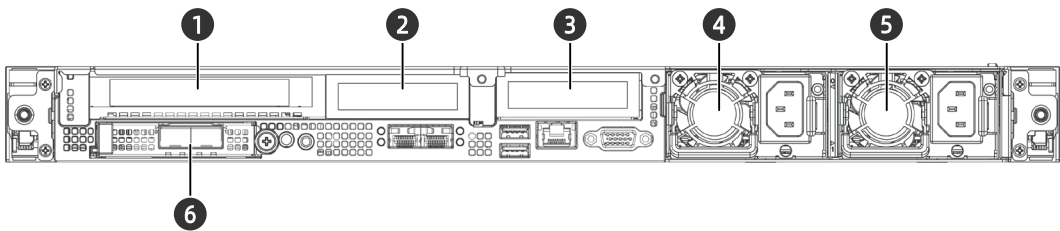

Item	Feature	Item	Feature
1	PCIe Slot 0	2	PCIe Slot 1
3	PCIe Slot 2	4	PSU0
5	PSU1	6	OCP 3.0 Slot Note: Supports an OCP 3.0 card.

Figure 5-21 Rear View 2

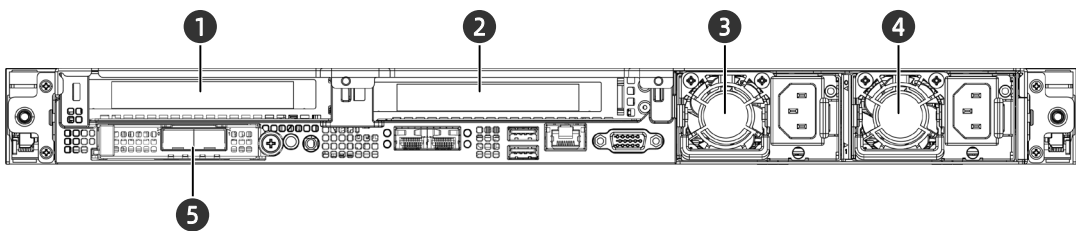

Item	Feature	Item	Feature
1	PCIe Slot 0	2	PCIe Slot 1
3	PSU0	4	PSU1
5	OCP 3.0 Slot Note: Supports an OCP 3.0 card.		

Figure 5-22 Rear View 3

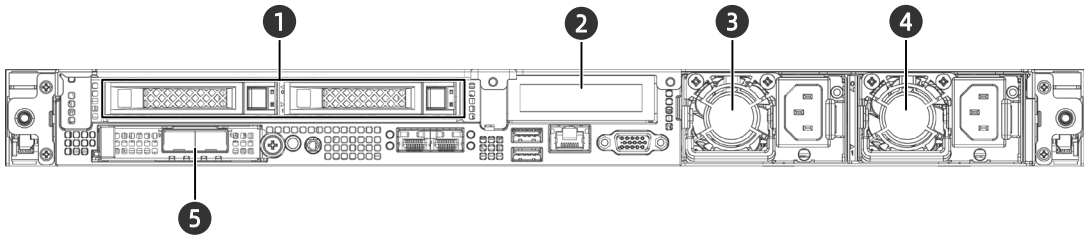

Item	Feature	Item	Feature
1	2.5-inch Drive Bay × 2	2	PCIe Slot 2
3	PSU0	4	PSU1
5	OCP 3.0 Slot Note: Supports an OCP 3.0 card.		

5.2.2 LEDs and Buttons

Figure 5-23 Rear Panel LEDs and Buttons 1

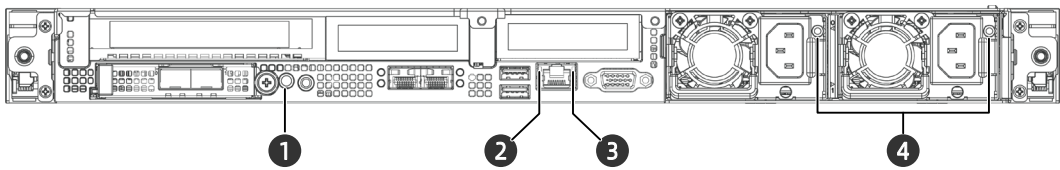

Item	Feature	Item	Feature
1	UID/BMC RST Button and LED	2	Management Network Port Link Speed LED
3	Management Network Port Link Activity LED	4	PSU LEDs

Figure 5-24 Rear Panel LEDs and Buttons 2

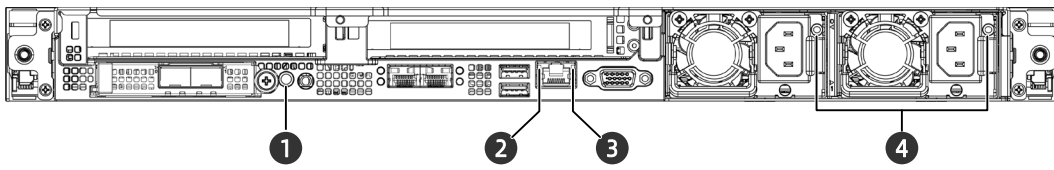

Item	Feature	Item	Feature
1	UID/BMC RST Button and LED	2	Management Network Port Link Speed LED
3	Management Network Port Link Activity LED	4	PSU LEDs

Figure 5-25 Rear Panel LEDs and Buttons 3

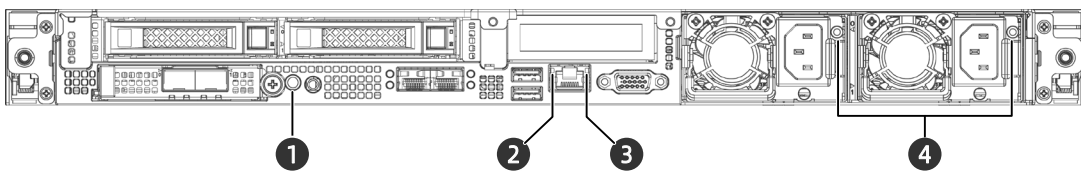

Item	Feature	Item	Feature
1	UID/BMC RST Button and LED	2	Management Network Port Link Speed LED
3	Management Network Port Link Activity LED	4	PSU LEDs

5.2.3 Ports

1. Port Location

Figure 5-26 Rear Panel Ports 1

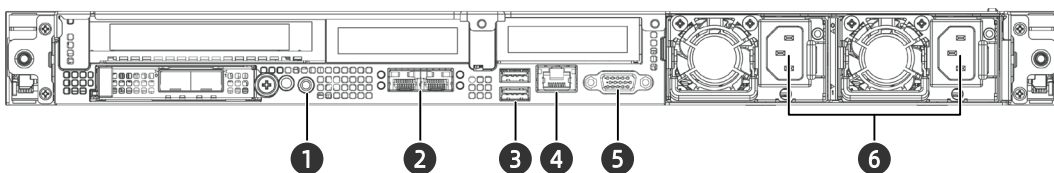

Item	Feature	Item	Feature
1	System/BMC Serial Port	2	Onboard Network Port
3	USB 3.0 Port	4	BMC Management Network Port
5	VGA Port	6	PSU Sockets

Figure 5-27 Rear Panel Ports 2

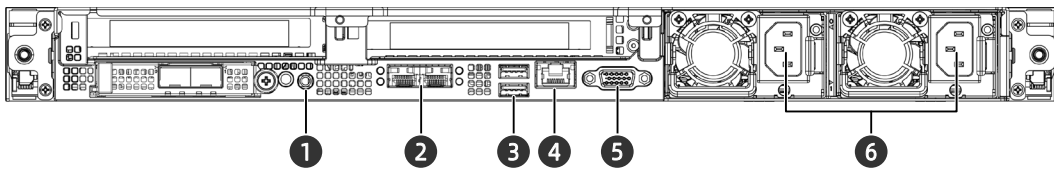

Item	Feature	Item	Feature
1	System/BMC Serial Port	2	Onboard Network Port
3	USB 3.0 Port	4	BMC Management Network Port
5	VGA Port	6	PSU Sockets

Figure 5-28 Rear Panel Ports 3

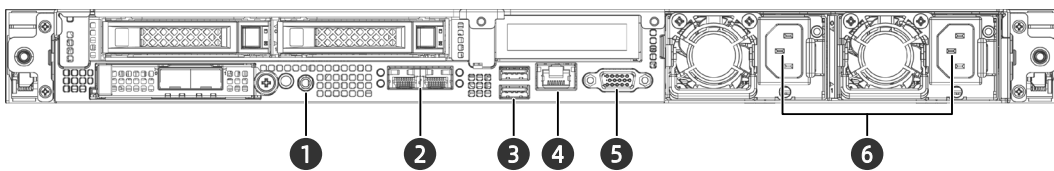

Item	Feature	Item	Feature
1	System/BMC Serial Port	2	Onboard Network Port
3	USB 3.0 Port	4	BMC Management Network Port
5	VGA Port	6	PSU Sockets

2. Port Description

Table 5-3 Rear Panel Port Description

Feature	Type	Quantity	Description
BMC Serial Port	3.5 mm headphone jack	1	Enables you to capture the BMC logs and debug the BMC. Note: The serial port uses a standard 3.5 mm jack with a default baud rate of 115,200 bit/s.
System Serial Port	3.5 mm headphone jack	1	Enables you to capture the system logs Note: The serial port uses a standard 3.5 mm jack with a default baud rate of 115,200 bit/s.

Feature	Type	Quantity	Description
USB 3.0 Port	USB 3.0	2	<p>Enables you to connect a USB 3.0 device to the system.</p> <p>Note:</p> <ul style="list-style-type: none"> The maximum current supported by the USB port is 0.9 A. Make sure the USB device is in good condition or it may cause the server to work abnormally.
BMC Management Network Port	RJ45	1	<p>Enables you to manage the server.</p> <p>Note:</p> <p>The port is a Gigabit Ethernet port of 100/1,000 Mb supporting self-negotiation.</p>
VGA Port	DB15	1	<p>Enables you to connect a display terminal, for example, a monitor or KVM to the system.</p>
PSU Socket	-	2	<p>Connected through a power cord. User can select the PSUs as needed.</p> <p>Note:</p> <p>Make sure that the rated power of every PSU is greater than the rated power of the server.</p>

5.3 Processors

- Supports up to 2 processors.
- When configuring only 1 processor, CPU0 socket should be preferred.
- Two processors used in the server must be of same model.
- For specific system processor options, consult your local sales representative or refer to [7.2 Hardware Compatibility](#).

Figure 5-29 Processor Locations

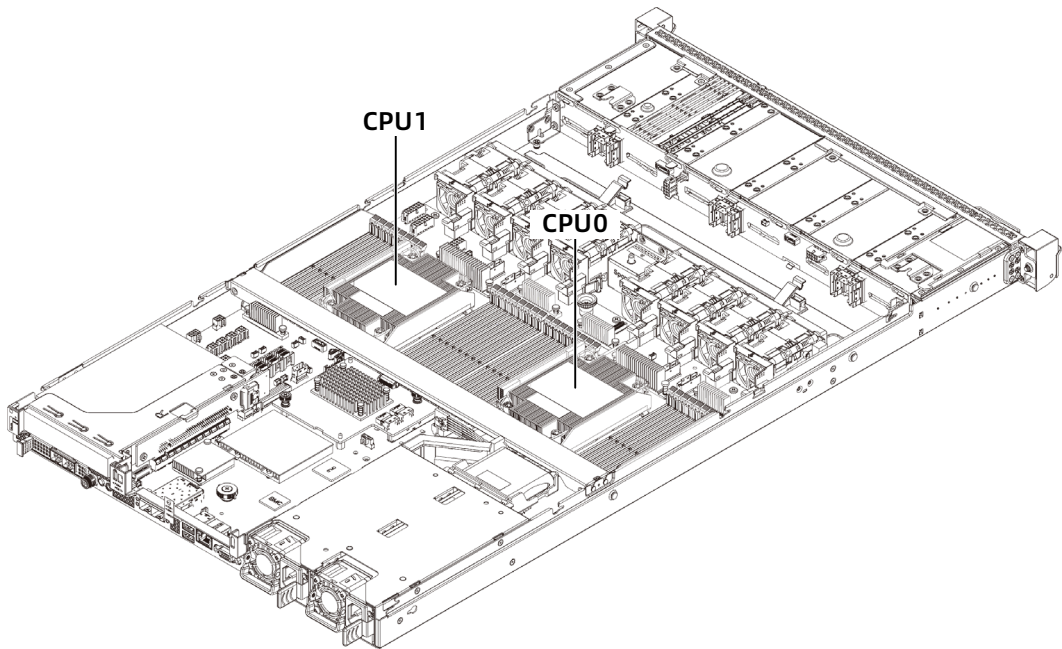

5.4 Memory

5.4.1 DDR4 DIMMs

1. Identification

To determine DIMM characteristics, refer to the label attached to the DIMM and the following figure and table.

Figure 5-30 DIMM Identification

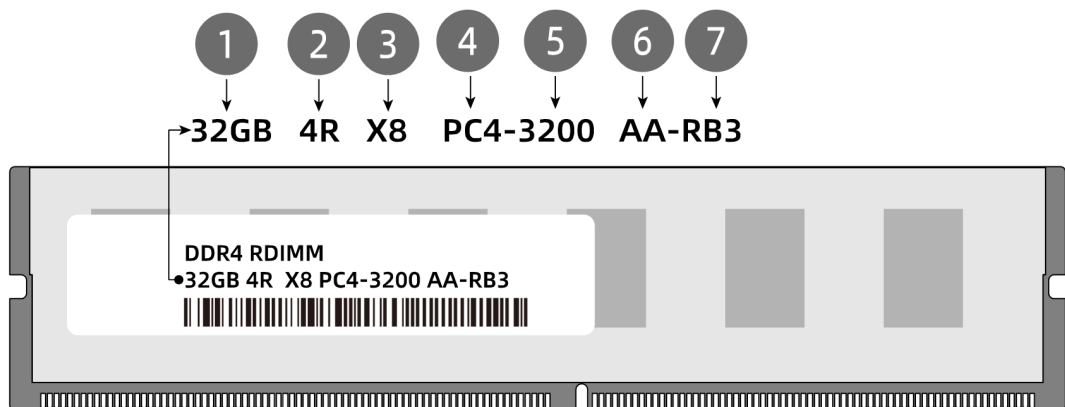

Item	Description	Example
1	Capacity	<ul style="list-style-type: none"> • 16 GB • 32 GB

Item	Description	Example
		<ul style="list-style-type: none"> • 64 GB • 128 GB • 256 GB
2	Rank(s)	<ul style="list-style-type: none"> • 1R = Single rank • 2R = Dual rank • 2S2R = Two ranks of two high stacked 3DS DRAM • 4DR = Four ranks of dual die packaged DRAM • 4R = Quad rank • 8R = Octal rank
3	Data width of DRAM	<ul style="list-style-type: none"> • x4 = 4 bits • x8 = 8 bits
4	DIMM slot type	PC4 = DDR4
5	Maximum memory speed	<ul style="list-style-type: none"> • 2,933 MT/s • 3,200 MT/s
6	CAS latency	SDP-chip-based <ul style="list-style-type: none"> • V = CAS-19-19-19 • Y = CAS-21-21-21 • AA = CAS-22-22-22 3DS-chip-based <ul style="list-style-type: none"> • V = CAS-22-19-19 • Y = CAS-24-21-21 • AA = CAS-26-22-22
7	DIMM type	<ul style="list-style-type: none"> • R = RDIMM • L = LRDIMM

2. Memory Subsystem Architecture

The NF5180M6 supports 32 DIMM slots and each processor supports 8 memory channels.

Within a channel, populate the DIMM slot with its silk screen ending with D0 first and second the DIMM slot with its silk screen ending with D1. For instance, within CPU0 Channel 0, populate CPU0_C0D0 first and second CPU0_C0D1.

Table 5-4 DIMM Slot List

CPU	Channel ID	Silk Screen
CPU0	Channel 0	CPU0_C0D0
		CPU0_C0D1
	Channel 1	CPU0_C1D0
		CPU0_C1D1
	Channel 2	CPU0_C2D0
		CPU0_C2D1
	Channel 3	CPU0_C3D0
		CPU0_C3D1
	Channel 4	CPU0_C4D0
		CPU0_C4D1
	Channel 5	CPU0_C5D0
		CPU0_C5D1
	Channel 6	CPU0_C6D0
		CPU0_C6D1
	Channel 7	CPU0_C7D0
		CPU0_C7D1
CPU1	Channel 0	CPU1_C0D0
		CPU1_C0D1
	Channel 1	CPU1_C1D0
		CPU1_C1D1
	Channel 2	CPU1_C2D0
		CPU1_C2D1
	Channel 3	CPU1_C3D0
		CPU1_C3D1
	Channel 4	CPU1_C4D0
		CPU1_C4D1
	Channel 5	CPU1_C5D0
		CPU1_C5D1
	Channel 6	CPU1_C6D0
		CPU1_C6D1
	Channel 7	CPU1_C7D0
		CPU1_C7D1

3. Compatibility

Refer to the following rules to select the DDR4 DIMMs.

 IMPORTANT

- A server must use DDR4 DIMMs with the same part number (P/N code). All DDR4 DIMMs operate at the same speed, which is the lowest of:
 - Memory speed supported by a specific CPU.
 - Maximum operating speed of a specific memory configuration.
 - Mixing DDR4 DIMM types (RDIMM, LRDIMM) or mixing DDR4 DIMM specifications (capacity, bit width, rank, height, etc.) is not supported.
 - For specific system memory options, consult your local sales representative or refer to [7.2 Hardware Compatibility](#).
-

- DDR4 DIMMs can be used with 3rd Gen Intel Xeon Scalable processors (Ice Lake). The maximum memory capacity supported is identical for different CPU models.
 - The total memory capacity is the sum of the capacity of all DDR4 DIMMs of all the CPUs.
-

 IMPORTANT

The number of ranks (up to 4 ranks for an RDIMM and up to 8 ranks for an LRDIMM) supported per channel restricts the maximum number of DIMMs supported per channel as follows: Maximum number of DIMMs supported per channel \leq Maximum number of ranks supported per channel/Number of ranks per DIMM.

- For an LRDIMM, more than 8 ranks are supported.
-

 NOTE

One quad-rank LRDIMM provides the same electrical load on a memory bus as a single-rank RDIMM.

Table 5-5 DDR4 DIMM Specifications

Item		Value			
Capacity per DDR4 DIMM (GB)		16	32	64	128
Type		RDIMM	RDIMM	RDIMM	RDIMM
Rated speed (MT/s)		3,200	3,200	3,200	3,200
Operating voltage (V)		1.2	1.2	1.2	1.2
Maximum number of DDR4 DIMMs supported in a server ^a		32	32	32	32
Maximum capacity of DDR4 DIMMs supported in a server (GB) ^b		512	1,024	2,048	4,096
Actual speed (MT/s)	1DPC ^c	3,200	3,200	3,200	3,200
	2DPC	3,200	3,200	3,200	3,200
<p>a: The maximum number of DDR4 DIMMs supported is based on 2 processors. If the 1-processor configuration is selected, the number should be halved.</p> <p>b: It indicates the maximum memory capacity supported when all the DIMM slots are populated with DDR4 DIMMs.</p> <p>c: DIMM Per Channel (DPC) is the number of DIMMs per memory channel.</p> <p>The information above is for reference only, consult your local sales representative for details.</p>					

4. Population Rules



This section describes the DIMM population rules when only DDR4 DIMMs are installed in a server. If mixing DDR4 DIMMs and PMems is required, refer to [5.4.2.4 PMem Population Rules](#).

General population rules for DDR4 DIMMs:

- Install DIMMs only when the corresponding processor has been installed.
- Mixing LRDIMMs and RDIMMs is not allowed.
- Install dummies in empty DIMM slots.

Population rules for DDR4 DIMMs in specific modes:

- Memory sparing
 - Follow the general population rules.
 - Each channel must have a valid online spare configuration.
 - Each channel can have a different online spare configuration.

- Each channel with a DIMM installed must have a spare rank.
- Memory mirroring
 - Follow the general population rules.
 - Each processor supports 2 integrated memory controllers (iMCs) and each iMC has two channels to be populated with DIMMs. Installed DIMMs must be of the same capacity and organization.
 - In a multi-processor configuration, each processor must have a valid memory mirroring configuration.
- Memory demand scrubbing/patrol scrubbing
 - Follow the general DIMM population rules.

5. DIMM Slot Layout

Up to 32 DDR4 DIMMs can be installed in the server, and a balanced DIMM configuration is recommended for optimal memory performance. DIMM configuration must be compliant with the DIMM population rules.



IMPORTANT

At least one DDR4 DIMM must be installed in the DIMM slot(s) corresponding to each CPU.

Figure 5-31 DIMM Slot Layout

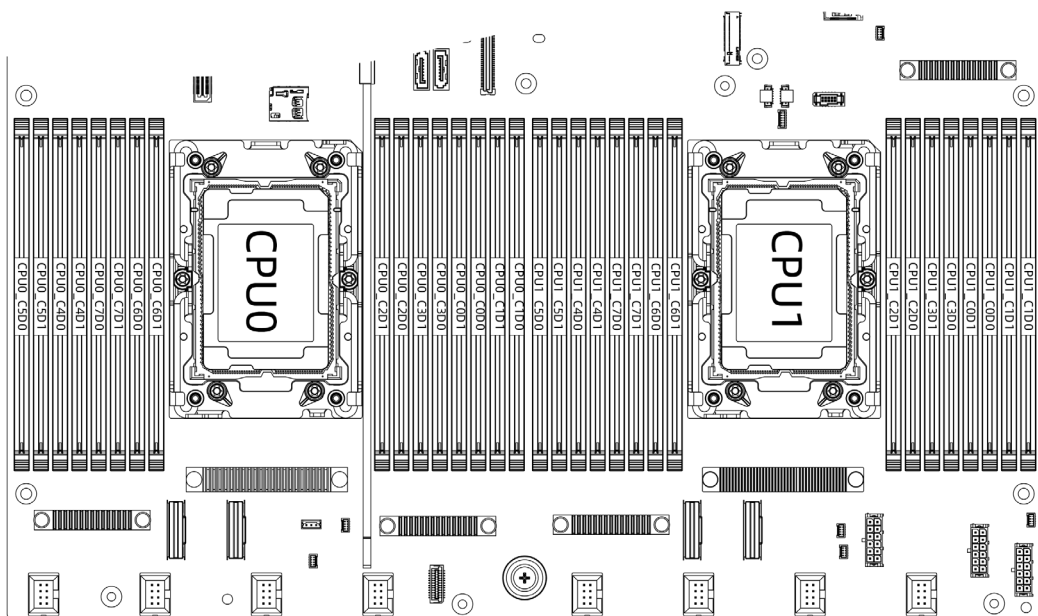

Table 5-6 DDR4 DIMM Population Rules (1-Processor Configuration)

Processor	Channel ID	Memory Slot	DIMM Quantity															
			1	2	3	4	5	6	7	8	9	10	11	12	13	14	15	16
CPU0	Channel 0	CPU0_C0D0	●	●		●		●		●				●				●
		CPU0_C0D1												●				●
	Channel 1	CPU0_C1D0						●		●				●				●
		CPU0_C1D1												●				●
	Channel 2	CPU0_C2D0				●		●		●				●				●
		CPU0_C2D1												●				●
	Channel 3	CPU0_C3D0								●								●
		CPU0_C3D1																●
	Channel 4	CPU0_C4D0		●		●		●		●				●				●
		CPU0_C4D1												●				●
	Channel 5	CPU0_C5D0						●		●				●				●
		CPU0_C5D1												●				●
	Channel 6	CPU0_C6D0				●		●		●				●				●
		CPU0_C6D1												●				●
	Channel 7	CPU0_C7D0								●								●
		CPU0_C7D1																●

Table 5-7 DDR4 DIMM Population Rules (2-Processor Configuration)

Processor	Channel ID	Memory Slot	DIMM Quantity															
			2	4	6	8	10	12	14	16	18	20	22	24	26	28	30	32
CPU0	Channel 0	CPU0_C0D0	●	●		●		●		●		●		●		●		●
		CPU0_C0D1												●				●
	Channel 1	CPU0_C1D0							●		●				●			●
		CPU0_C1D1												●				●
	Channel 2	CPU0_C2D0				●		●		●					●			●
		CPU0_C2D1												●				●
	Channel 3	CPU0_C3D0									●							●
		CPU0_C3D1																●
	Channel 4	CPU0_C4D0		●		●		●		●					●			●
		CPU0_C4D1													●			●
	Channel 5	CPU0_C5D0							●		●				●			●
		CPU0_C5D1													●			●
	Channel 6	CPU0_C6D0				●		●		●					●			●
		CPU0_C6D1													●			●
Channel 7	CPU0_C7D0									●							●	
	CPU0_C7D1																●	
CPU1	Channel 0	CPU1_C0D0	●	●		●		●		●		●		●		●		●
		CPU1_C0D1													●			●
	Channel 1	CPU1_C1D0							●		●				●			●
		CPU1_C1D1													●			●
	Channel 2	CPU1_C2D0				●		●		●					●			●
		CPU1_C2D1													●			●
	Channel 3	CPU1_C3D0									●							●
		CPU1_C3D1																●
	Channel 4	CPU1_C4D0		●		●		●		●					●			●
		CPU1_C4D1													●			●
	Channel 5	CPU1_C5D0							●		●				●			●
		CPU1_C5D1													●			●
	Channel 6	CPU1_C6D0				●		●		●					●			●
		CPU1_C6D1													●			●
Channel 7	CPU1_C7D0									●							●	
	CPU1_C7D1																●	

6. Memory Protection Technology

DDR4 DIMMs support the following memory protection technologies:

- ECC (Error Correcting Code)
- Memory mirroring
- Memory rank sparing
- SDDC (Single Device Data Correction)
- ADDDC (Adaptive Double- Device Data Correction)

- Power up-Post Package Repair (PPR)

5.4.2 PMems

1. Identification

Figure 5-32 PMem Identification

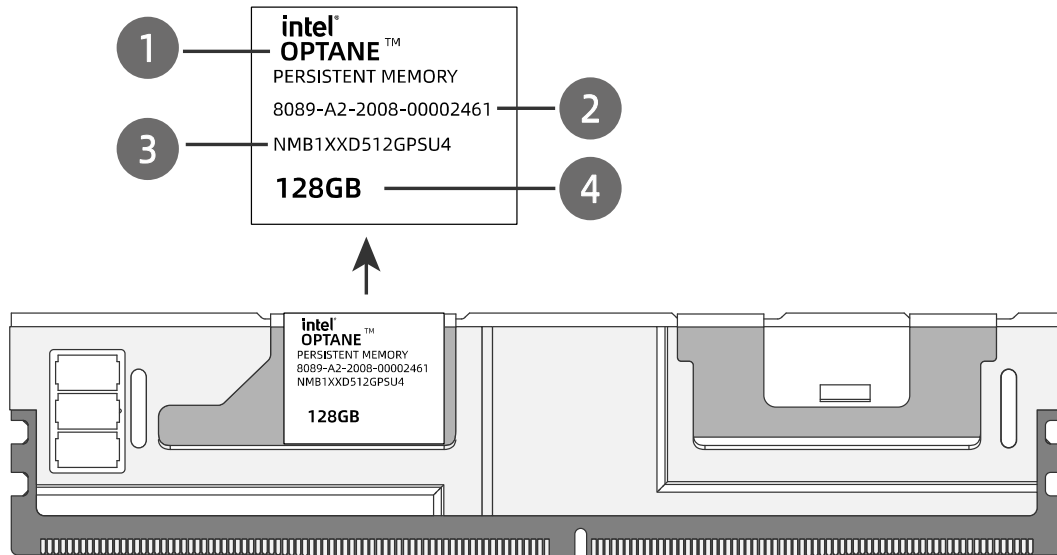

Item	Description	Example
1	Component name	Intel Optane Persistent Memory
2	Serial number	8089-A2-2008-00002461
3	Model	NMB1XXD512GPSU4
4	Capacity	128 GB

2. Memory Subsystem Architecture

The NF5180M6 supports 32 DIMM slots and 8 channels per CPU with 2 DIMM slots per channel. Only one PMem can be populated in each channel.

PMems must be used with DDR4 DIMMs.

Table 5-8 DIMM Slot List

CPU	Channel ID	Silk Screen
CPU0	Channel 0	CPU0_C0D0
		CPU0_C0D1
	Channel 1	CPU0_C1D0
		CPU0_C1D1
	Channel 2	CPU0_C2D0
		CPU0_C2D1

CPU	Channel ID	Silk Screen	
	Channel 3	CPU0_C3D0	
		CPU0_C3D1	
	Channel 4	CPU0_C4D0	
		CPU0_C4D1	
	Channel 5	CPU0_C5D0	
		CPU0_C5D1	
	Channel 6	CPU0_C6D0	
		CPU0_C6D1	
	Channel 7	CPU0_C7D0	
		CPU0_C7D1	
	CPU1	Channel 0	CPU1_C0D0
			CPU1_C0D1
		Channel 1	CPU1_C1D0
			CPU1_C1D1
Channel 2		CPU1_C2D0	
		CPU1_C2D1	
Channel 3		CPU1_C3D0	
		CPU1_C3D1	
Channel 4		CPU1_C4D0	
		CPU1_C4D1	
Channel 5		CPU1_C5D0	
		CPU1_C5D1	
Channel 6		CPU1_C6D0	
		CPU1_C6D1	
Channel 7	CPU1_C7D0		
	CPU1_C7D1		

3. Compatibility

Refer to the following rules to configure PMems:

 IMPORTANT

- PMems must be used with DDR4 DIMMs.
- For specific system PMem options, consult us.
- PMems must be used with the 3rd Gen Intel Xeon Scalable processors (Ice Lake). The maximum memory capacity supported is identical for all CPU models.
- PMems can only be configured into two modes: App Direct Mode (AD) and Memory Mode (MM), and the calculation formula for the total memory

capacity is as follows:

- AD: Total memory capacity = sum of all PMem capacities + sum of DDR4 DIMM capacities.
 - MM: Total memory capacity = sum of all PMem capacities (DDR4 DIMMs operate as cache only and do not count toward the total memory capacity)
 - For detailed information on the specific capacity type for a single PMem module, consult us.
 - The maximum number of memory supported depends on the memory type and rank quantity.
-

Table 5-9 PMem Specifications

Item	Value		
Capacity per PMem (GB)	128	256	512
Rated speed (MT/s)	3,200	3,200	3,200
Operating voltage (V)	1.2	1.2	1.2
Maximum number of PMems supported in a server ^a	16	16	16
Maximum capacity of PMems supported in a server (GB) ^b	2,048	4,096	8,192
Actual speed (MT/s)	3,200	3,200	3,200
a: The maximum number of PMems supported is based on 2 processors. If the server is 1-processor configuration, the number should be halved. b: The maximum capacity of PMem supported varies with the operating modes of PMem. The above information is for reference only, consult your local sales representative for details.			

4. PMem Population Rules

- General population rules for PMems:
 - DDR4 DIMM types used with PMems include RDIMMs and LRDIMMs.
 - A server must use PMems with the same part number (P/N code).
 - In a server, DDR4 DIMMs used with PMems must have the same part number (P/N code).
- Population rules for PMems in specific modes:

- AD: In a server, the recommended capacity ratio of DDR4 DIMMs to PMems is between 1:1 and 1:8.
- MM: In a server, the recommended capacity ratio of DDR4 DIMMs to PMems is between 1:4 and 1:16.

5. DIMM Slot Layout

Up to 16 PMems can be installed in the server, and PMems must be used with DDR4 DIMMs. PMem configuration must be compliant with the PMem population rules.

Figure 5-33 DIMM Slot Layout

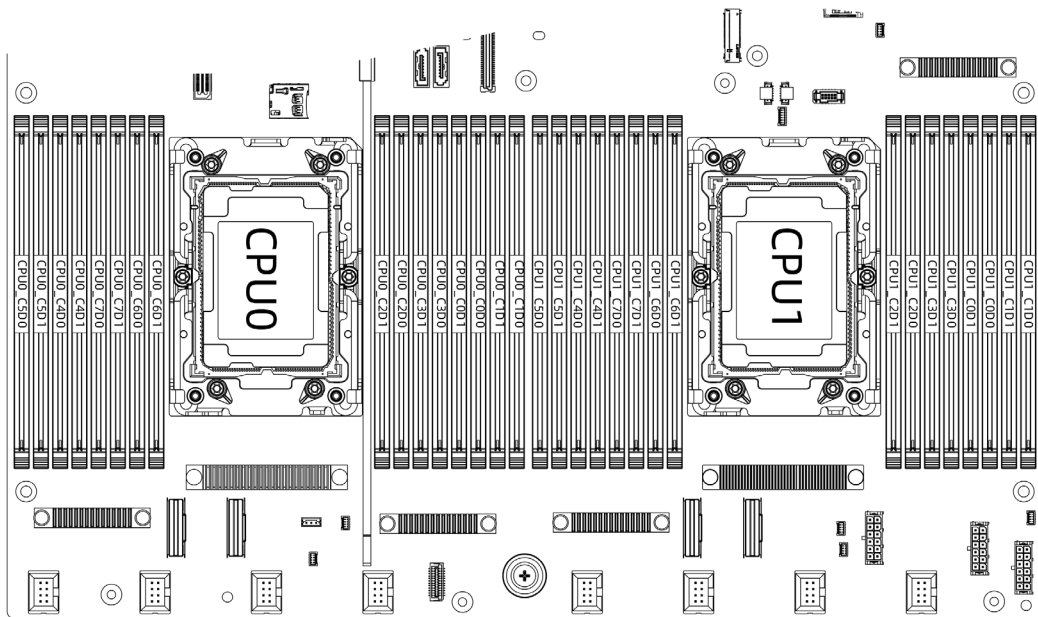

Table 5-10 PMem Population Rules (1-Processor Configuration)

Processor	Channel ID	Memory Slot	Population Rules								
			●: DDR4 DIMM ○:PMem								
			AD	MM	AD	AD	AD	MM	AD	MM	AD
4+4		6+1		8+1		8+4		8+8		12+2	
CPU0	Channel 0	CPU0_C0D0	●		●	●	●	●	●	●	●
		CPU0_C0D1				○	○	○			●
	Channel 1	CPU0_C1D0	○		●	●	●	●	●	●	○
		CPU0_C1D1							○		
	Channel 2	CPU0_C2D0	●		●	●	●	●	●	●	●
		CPU0_C2D1						○	○		●
	Channel 3	CPU0_C3D0	○		○	●	●	●	●	●	●
		CPU0_C3D1							○		●
	Channel 4	CPU0_C4D0	●		●	●	●	●	●	●	●
		CPU0_C4D1						○	○		●
	Channel 5	CPU0_C5D0	○		●	●	●	●	●	●	○
		CPU0_C5D1							○		
	Channel 6	CPU0_C6D0	●		●	●	●	●	●	●	●
		CPU0_C6D1						○	○		●
	Channel 7	CPU0_C7D0	○			●	●	●	●	●	●
		CPU0_C7D1							○		●

Table 5-11 PMem Population Rules (2-Processor Configuration)

Processor	Channel ID	Memory Slot	Population Rules									
			●: DDR4 DIMM ○:PMem									
			AD	MM	AD	AD	AD	MM	AD	MM	AD	
8+8		12+2		16+2		16+8		16+16		24+4		
CPU0	Channel 0	CPU0_C0D0	●		●	●	●	●	●	●	●	●
		CPU0_C0D1				○	○	○	○	○	○	●
	Channel 1	CPU0_C1D0	○		●	●	●	●	●	●	●	○
		CPU0_C1D1								○		
	Channel 2	CPU0_C2D0	●		●	●	●	●	●	●	●	●
		CPU0_C2D1						○	○	○	○	●
	Channel 3	CPU0_C3D0	○		○	●	●	●	●	●	●	●
		CPU0_C3D1								○		●
	Channel 4	CPU0_C4D0	●		●	●	●	●	●	●	●	●
		CPU0_C4D1						○	○	○	○	●
	Channel 5	CPU0_C5D0	○		●	●	●	●	●	●	●	○
		CPU0_C5D1								○		
	Channel 6	CPU0_C6D0	●		●	●	●	●	●	●	●	●
		CPU0_C6D1						○	○	○	○	●
Channel 7	CPU0_C7D0	○		○	●	●	●	●	●	●	●	
	CPU0_C7D1								○		●	
CPU1	Channel 0	CPU1_C0D0	●		●	●	●	●	●	●	●	●
		CPU1_C0D1				○	○	○	○	○	○	●
	Channel 1	CPU1_C1D0	○		●	●	●	●	●	●	●	○
		CPU1_C1D1								○		
	Channel 2	CPU1_C2D0	●		●	●	●	●	●	●	●	●
		CPU1_C2D1						○	○	○	○	●
	Channel 3	CPU1_C3D0	○		○	●	●	●	●	●	●	●
		CPU1_C3D1								○		●
	Channel 4	CPU1_C4D0	●		●	●	●	●	●	●	●	●
		CPU1_C4D1						○	○	○	○	●
	Channel 5	CPU1_C5D0	○		●	●	●	●	●	●	●	○
		CPU1_C5D1								○		
	Channel 6	CPU1_C6D0	●		●	●	●	●	●	●	●	●
		CPU1_C6D1						○	○	○	○	●
Channel 7	CPU1_C7D0	○		○	●	●	●	●	●	●	●	
	CPU1_C7D1								○		●	

6. Memory Protection Technology

PMems support the following memory protection technologies:

- PMem module Error Detection and Correction
- PMem module Device Failure Recovery - SDDC
- PMem module Package Sparing - DDDC
- PMem module Patrol Scrubbing

- PMem module Address Error Detection
- PMem module Data Poisoning - Corrupt Data Containment
- PMem module Viral
- PMem module Address Range Scrub (ARS)
- PMem module Error Injection
- DDR-T Command and Address Parity Check and Retry
- DDR-T Read Write Data ECC Check and Retry
- PMem module Faulty DIMM Isolation
- PMem module Error Reporting

5.5 Storage

5.5.1 Drive Configurations

Table 5-12 Drive Configurations

Configuration	Front Drive	Rear Drive	Internal Drive	Drive Management
2 × E1.S + 2 × SATA M.2 + 4 × 3.5-inch SAS/SATA Drive	2 × E1.S in drive bays 0-1, 2 × SATA M.2 in drive bays 2-3, and 4 × 3.5-inch SAS/SATA drive in drive bays 4-7	2 × 2.5-inch SAS/SATA drive	NVMe M.2 drives on an M.2 adapter	<ul style="list-style-type: none"> • SAS/SATA drive: SAS/RAID controller card/PCH • E1.S: directly connected to CPU • Internal M.2: directly connected to CPU
2 × E1.S + 2 × SATA M.2 + 4 × 2.5-inch NVMe Drive	2 × E1.S in drive bays 0-1, 2 × SATA M.2 in drive bays 2-3, and 4 × 2.5-inch NVMe drive in drive bays 4-7	2 × 2.5-inch SAS/SATA drive	NVMe M.2 drives on an M.2 adapter	<ul style="list-style-type: none"> • SAS/SATA drive: SAS/RAID controller card/PCH

Configuration	Front Drive	Rear Drive	Internal Drive	Drive Management
				<ul style="list-style-type: none"> • E1.S: directly connected to CPU • NVMe drive: directly connected to CPU • Internal M.2: directly connected to CPU
10 × 2.5-inch SAS/SATA Drive	10 × 2.5-inch SAS/SATA drive in drive bays 0-9	2 × 2.5-inch SAS/SATA drive	NVMe M.2 drives on an M.2 adapter	<ul style="list-style-type: none"> • SAS/SATA drive: SAS/RAID controller card/PCH • Internal M.2: directly connected to CPU
10 × 2.5-inch NVMe Drive	10 × 2.5-inch NVMe drive in drive bays 0-9	2 × 2.5-inch SAS/SATA drive	NVMe M.2 drives on an M.2 adapter	<ul style="list-style-type: none"> • NVMe drive: directly connected to CPU • Internal M.2: directly connected to CPU
2 × E1.S + 2 × SATA M.2 + 8 × 2.5-inch SAS/SATA Drive	8 × 2.5-inch SAS/SATA drive in drive bays 0-7, 2 × E1.S in drive bays 8-9, and 2 × SATA M.2 in drive bays 10-11	2 × 2.5-inch SAS/SATA drive	NVMe M.2 drives on an M.2 adapter	<ul style="list-style-type: none"> • SAS/SATA drive: SAS/RAID controller card/PCH • E1.S: directly connected to CPU

Configuration	Front Drive	Rear Drive	Internal Drive	Drive Management
				<ul style="list-style-type: none"> Internal M.2: directly connected to CPU
2 × E1.S + 2 × SATA M.2 + 8 × 2.5-inch NVMe Drive	8 × 2.5-inch NVMe drive in drive bays 0-7, 2 × E1.S in drive bays 8-9, and 2 × SATA M.2 in drive bays 10-11	2 × 2.5-inch SAS/SATA drive	NVMe M.2 drives on an M.2 adapter	<ul style="list-style-type: none"> SAS/SATA drive: SAS/RAID controller card/PCH E1.S: directly connected to CPU NVMe drive: directly connected to CPU Internal M.2: directly connected to CPU
12 × 2.5-inch SAS/SATA Drive	12 × 2.5-inch SAS/SATA drive in drive bays 0-11	2 × 2.5-inch SAS/SATA drive	NVMe M.2 drives on an M.2 adapter	<ul style="list-style-type: none"> SAS/SATA drive: SAS/RAID controller card/PCH Internal M.2: directly connected to CPU
12 × 2.5-inch NVMe Drive	12 × 2.5-inch NVMe drive in drive bays 0-11	2 × 2.5-inch SAS/SATA drive	NVMe M.2 drives on an M.2 adapter	<ul style="list-style-type: none"> NVMe drive: directly connected to CPU Internal M.2: directly

Configuration	Front Drive	Rear Drive	Internal Drive	Drive Management
				connected to CPU
32 × E1.S SSD	32 × E1.S in drive bays 0-31	2 × 2.5-inch SAS/SATA drive	NVMe M.2 drives on an M.2 adapter	<ul style="list-style-type: none"> E1.S: connected to CPU via PCIe switch
EVAC + 4 × 2.5-inch SAS/SATA Drive	4 × 2.5-inch SAS/SATA drive in drive bays 0-4	2 × 2.5-inch SAS/SATA drive	NVMe M.2 drives on an M.2 adapter	<ul style="list-style-type: none"> SAS/SATA drive: SAS/RAID controller card/PCH Internal M.2: directly connected to CPU
EVAC + 4 × 2.5-inch NVMe Drive	4 × 2.5-inch NVMe drive in drive bays 0-3	2 × 2.5-inch SAS/SATA drive	NVMe M.2 drives on an M.2 adapter	<ul style="list-style-type: none"> NVMe drive: directly connected to CPU Internal M.2: directly connected to CPU

5.5.2 Drive Numbering

Figure 5-34 4 × 3.5-inch Drive + 2 × E1.S SSD + 2 × M.2 SSD Configuration

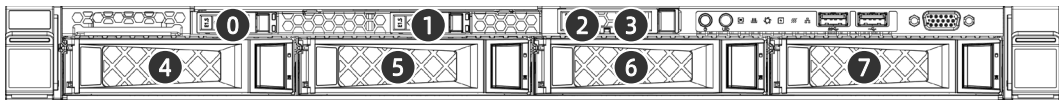

Physical Drive No.	Drive No. Identified by ISBMC	Drive No. Identified by RAID Controller Card (3.5-inch drives connected to a RAID controller card)
0	0	-
1	1	-

Physical Drive No.	Drive No. Identified by ISBMC	Drive No. Identified by RAID Controller Card (3.5-inch drives connected to a RAID controller card)
2	2	-
3	3	-
4	0	0
5	1	1
6	2	2
7	3	3

Figure 5-35 4 × 3.5-inch Drive + 4 × 2.5-inch Drive Configuration



Physical Drive No.	Drive No. Identified by ISBMC	Drive No. Identified by RAID Controller Card (1 RAID controller card is used)
0	0	0
1	1	1
2	2	2
3	3	3
4	4	4
5	5	5
6	6	6
7	7	7

Figure 5-36 10 × 2.5-inch Drive Configuration

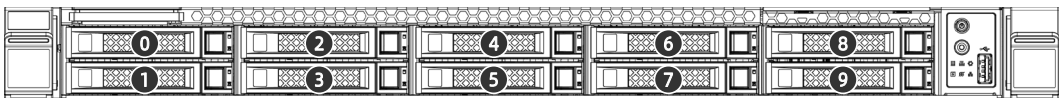

Physical Drive No.	Drive No. Identified by ISBMC	Drive No. Identified by RAID Controller Card (1 16i RAID controller card is used)
0	0	0
1	1	1

Physical Drive No.	Drive No. Identified by ISBMC	Drive No. Identified by RAID Controller Card (1 16i RAID controller card is used)
2	2	2
3	3	3
4	4	4
5	5	5
6	6	6
7	7	7
8	8	8
9	9	9

Figure 5-37 12 × 2.5-inch Drive Configuration

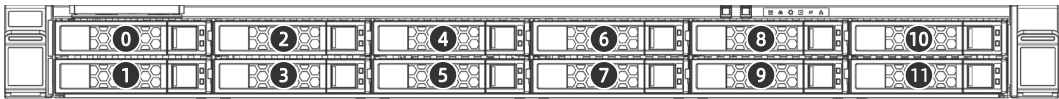

Physical Drive No.	Drive No. Identified by ISBMC	Drive No. Identified by RAID Controller Card (1 16i RAID controller card is used)
0	0	0
1	1	1
2	2	2
3	3	3
4	4	4
5	5	5
6	6	6
7	7	7
8	8	8
9	9	9
10	10	10
11	11	11

Figure 5-38 8 × 2.5-inch Drive + 2 × E1.S SSD + 2 × M.2 SSD Configuration (8 × NVMe)

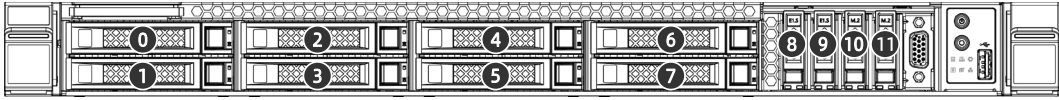

Physical Drive No.	Drive No. Identified by ISBMC	Drive No. Identified by RAID Controller Card (2.5-inch drives connected to a RAID controller card)
0	0	0
1	1	1
2	2	2
3	3	3
4	4	4
5	5	5
6	6	6
7	7	7
8	0	-
9	1	-
10	0	-
11	1	-

Figure 5-39 32 × E1.S SSD Configuration

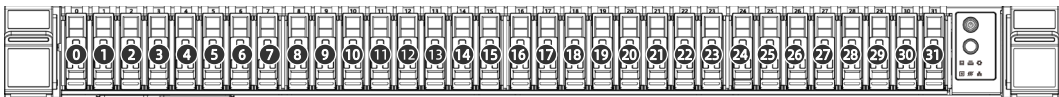

Physical Drive No.	Drive No. Identified by ISBMC	Drive No. Identified by RAID Controller Card	Physical Drive No.	Drive No. Identified by ISBMC	Drive No. Identified by RAID Controller Card
0	0	0	16	16	16
1	1	1	17	17	17
2	2	2	18	18	18
3	3	3	19	19	19
4	4	4	20	20	20
5	5	5	21	21	21

Physical Drive No.	Drive No. Identified by ISBMC	Drive No. Identified by RAID Controller Card	Physical Drive No.	Drive No. Identified by ISBMC	Drive No. Identified by RAID Controller Card
6	6	6	22	22	22
7	7	7	23	23	23
8	8	8	24	24	24
9	9	9	25	25	25
10	10	10	26	26	26
11	11	11	27	27	27
12	12	12	28	28	28
13	13	13	29	29	29
14	14	14	30	30	30
15	15	15	31	31	31

Figure 5-40 EVAC Heatsink Configuration

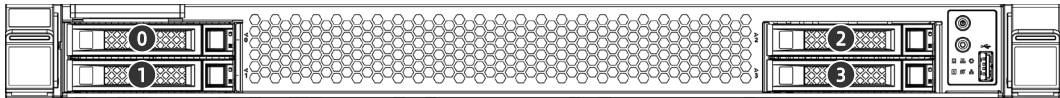

Physical Drive No.	Drive No. Identified by ISBMC	Drive No. Identified by RAID Controller Card
0	0	0
1	1	1
2	2	2
3	3	3

5.5.3 Drive LEDs

1. SAS/SATA Drive LEDs

Figure 5-41 SAS/SATA Drive LEDs

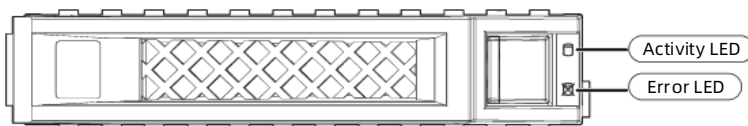

Table 5-13 SAS/SATA Drive LED Description

Activity LED (Green)	Error LED (Blue/Red)		Status Description
	Blue	Red	
Off	Off	RAID created	RAID not created
		Solid on	Off
Solid on	Off	Off	Drive present but not in use
Flashing	Off	Off	Drive present and in use
Flashing	Solid pink		Copyback/Rebuild in progress
Solid on	Solid on	Off	Drive selected but not in use
Flashing	Solid on	Off	Drive selected and in use
Off	Solid on	Off	Drive selected and failed
-	Off	Solid on	Drive failure

5.5.4 RAID Controller Cards

The RAID controller card supports RAID configuration, RAID level migration, drive roaming, and other functions. For specific RAID controller card options, consult your local sales representative or refer to [7.2 Hardware Compatibility](#).

5.6 Network

NICs provide network expansion capabilities.

- The OCP slots support OCP 3.0 cards. Users can select the optional OCP 3.0 cards as needed.
- The PCIe slots support PCIe NICs. Users can select the cards as needed.
- For specific NIC options, consult your local sales representative or refer to [7.2 Hardware Compatibility](#).

5.7 I/O Expansion

5.7.1 PCIe Cards

- The PCIe cards provide system expansion capabilities.
- The server supports 1 dedicated OCP 3.0 slot and up to 3 PCIe 3.0 slots.

- For specific PCIe expansion card options, consult your local sales representative or refer to [7.2 Hardware Compatibility](#).

5.7.2 PCIe Slots

1. PCIe Slot Locations

Figure 5-42 PCIe Slots - 3 × PCIe

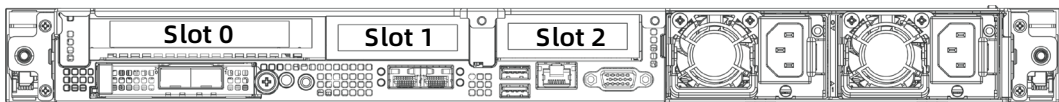

- Slot 0 and slot 1 reside in the left PCIe riser-card assembly.
- Slot 2 resides in the right PCIe riser-card assembly.

Figure 5-43 PCIe Slots - 2 × PCIe

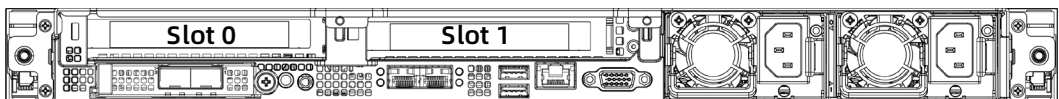

- Slot 0 resides in the left PCIe riser-card assembly.
- Slot 1 resides in the right PCIe riser-card assembly.

Figure 5-44 PCIe Slot - 1 × PCIe

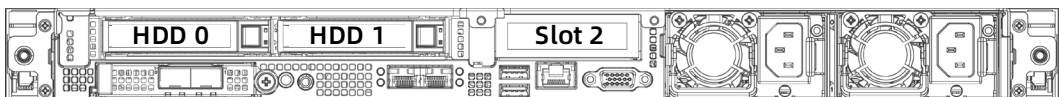

- Slot 2 resides in the right PCIe riser-card assembly.

2. PCIe Riser-Card Assemblies

- The left PCIe riser-card assembly 1 provides 2 PCIe slots. Slots 0 and 1 reside in this assembly.

Figure 5-45 Left PCIe Riser-Card Assembly 1

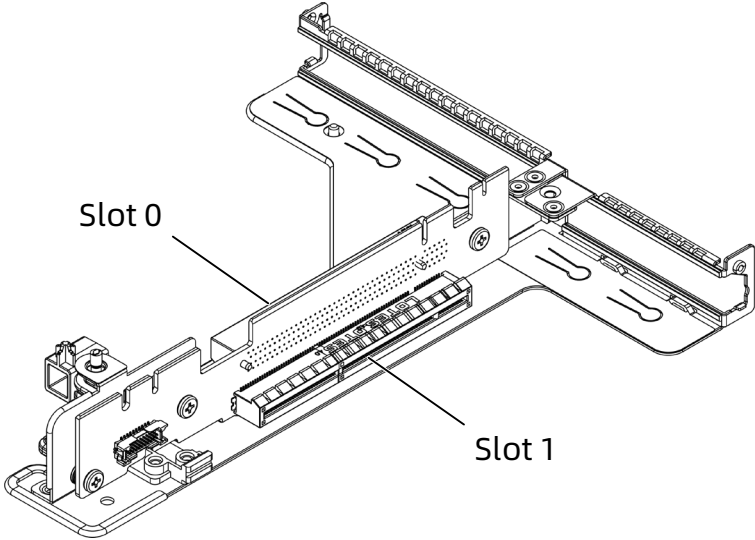

- The right PCIe riser-card assembly 1 provides 1 PCIe slot. Slot 2 resides in this assembly.

Figure 5-46 Right PCIe Riser-Card Assembly 1

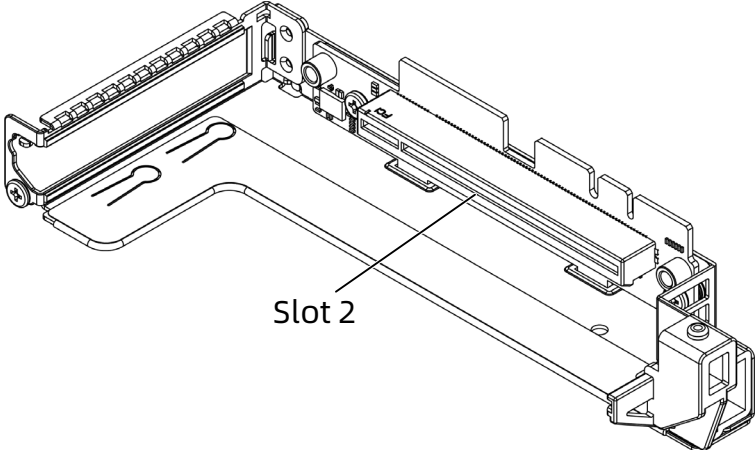

- The left PCIe riser-card assembly 2 provides 1 PCIe slot. Slot 0 resides in this assembly.

Figure 5-47 Left PCIe Riser-Card Assembly 2

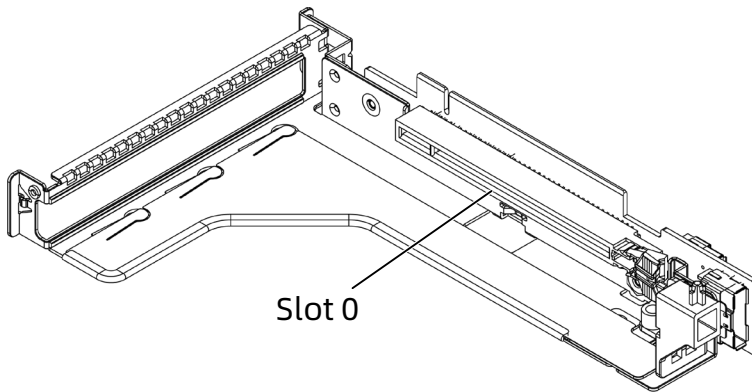

- The right PCIe riser-card assembly 2 provides 1 PCIe slot. Slot 1 resides in this assembly.

Figure 5-48 Right PCIe Riser-Card Assembly 2

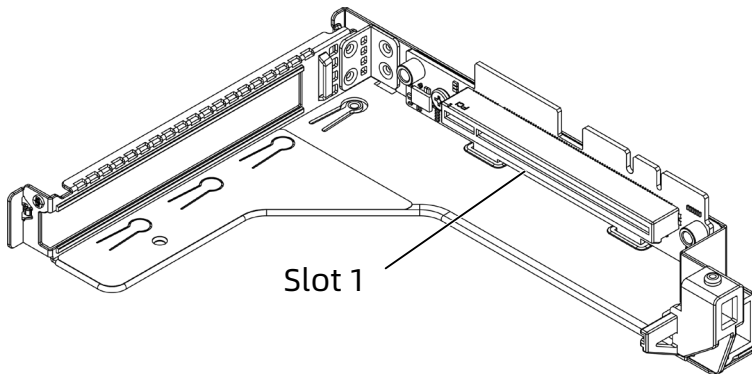

5.7.3 PCIe Slot Description



NOTE

When CPU1 is not present, the corresponding PCIe slots do not work.

1. Servers Configured with Rear PCIe Riser-Card Assemblies

Table 5-14 PCIe Slot Description

PCIe Slot	Owner	PCIe Standard	Connector Width	Bus Width	Port Number	Root Port (B/D/F)	Form Factor
Slot 0	CPU0	PCIe 4.0	×16	×16	PE2	32:00.0	HHHL
Slot 1	CPU1	PCIe 4.0	×16	×16	PE1	57:00.0	HHHL
Slot 2	CPU1	PCIe 4.0	×16	×16	PE2	ec:02.0	HHHL
OCP 3.0 Slot	CPU0	PCIe 4.0	×16	×16	PE0	23:00.0	Standard OCP 3.0 slot

5.8 PSUs

- Supports 1 or 2 PSUs.
- Supports AC or DC power input.
- The PSUs are hot-swappable.
- The server supports 2 PSUs with 1+1 redundancy.
- The server must use PSUs of the same part number (P/N code).
- The server provides short-circuit protection, and provides PSUs supporting dual-live-wire input.

Figure 5-49 PSU Locations

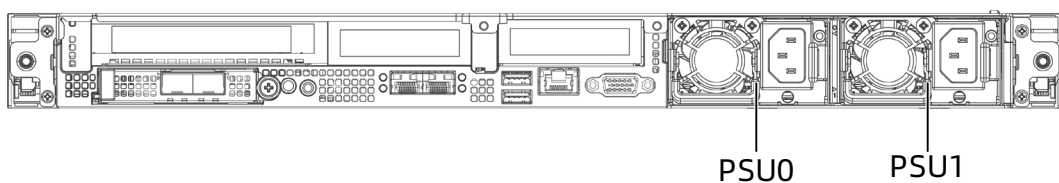

5.9 Fans

- Supports 8 4056 fans. High-performance fans and standard fans can be selected based on actual configuration.
- The fans are hot-swappable.

- Support N+1 redundancy, allowing the server to continue working normally when one fan fails.
- Supports intelligent fan speed control.
- The server must use fans of the same part number (P/N code).

Figure 5-50 Fan Module Locations

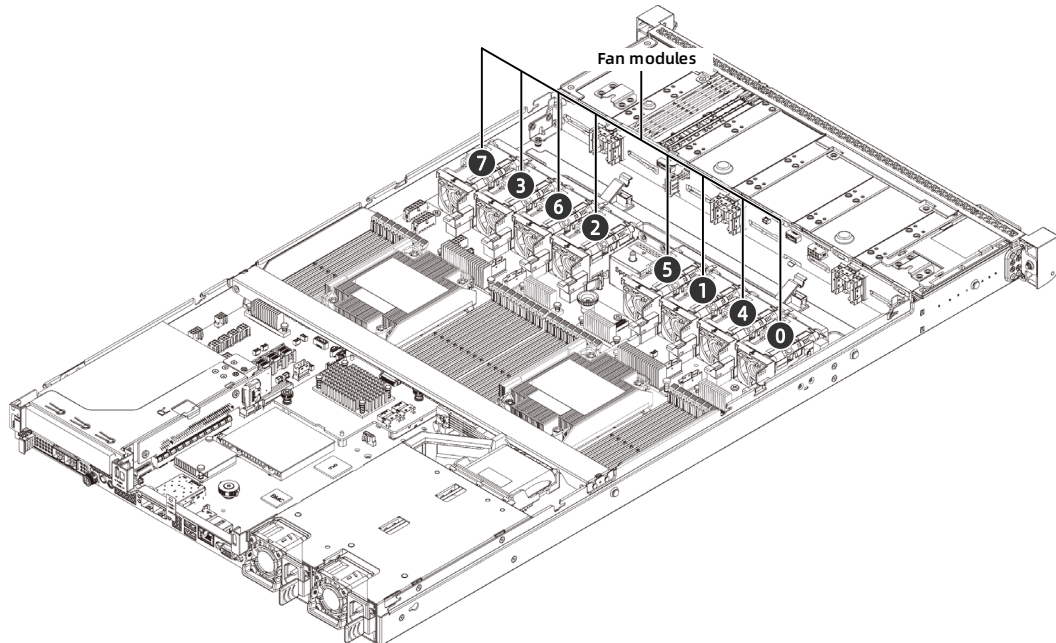

5.10 LCD Module (Optional)

5.10.1 Function

The LCD module reads server-related information from the BMC, such as the operating status of processors and memories, network status, logs, and alerts, and transmits the information to client mobile terminals via Bluetooth.

The LCD module synchronizes information with the ISBMC through I²C and can display information on an LCD screen or in the app. The server's basic information, system status and alert diagnosis can be displayed in the app via Bluetooth, facilitating the operation and maintenance.

Figure 5-51 How LCD Subsystem Works

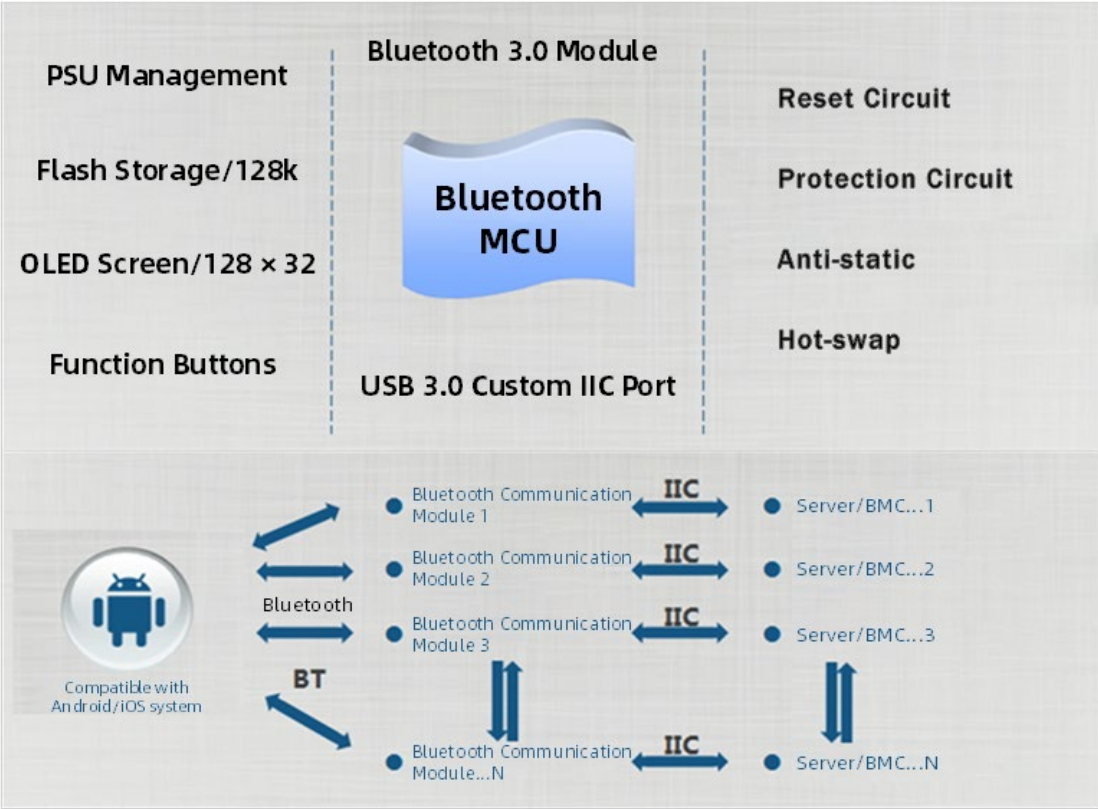

5.10.2 Interface

Figure 5-52 App Home Screen

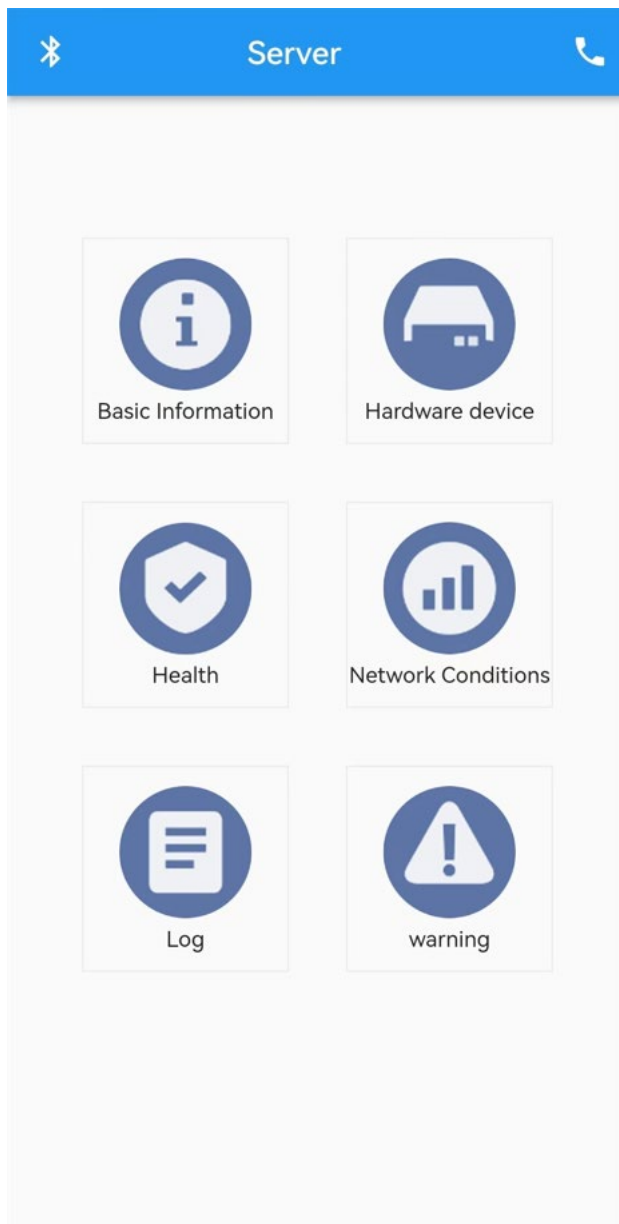

5.11 Boards

5.11.1 Motherboard

Figure 5-53 Motherboard Layout

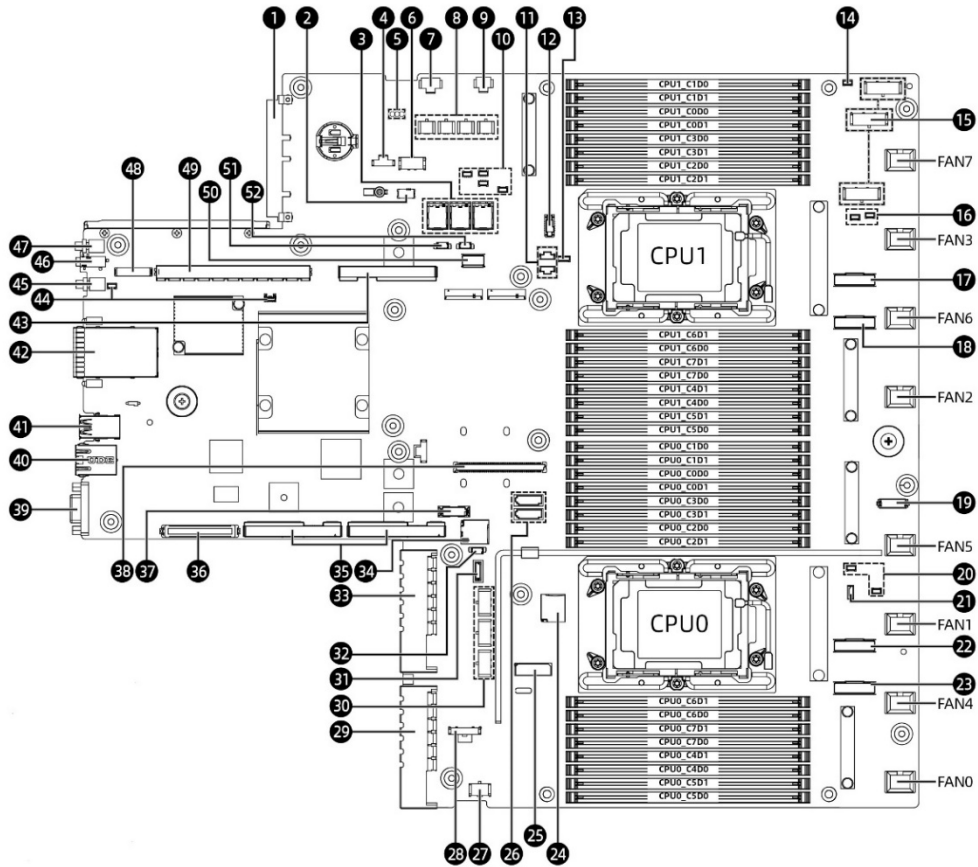

Item	Feature	Item	Feature
1	OC3.0 Connector	2	TPM Slot
3	Mini_SAS Connector × 3	4	GPU_RISER0 Power Connector
5	CLR_CMOS Connector	6	GPU0&MID_PClE Power Connector
7	Mid-Backplane Power Connector	8	Rear Backplane Power Connector × 4
9	GPU_RISER1&MID_PClE Power Connector	10	I ² C Connector × 4
11	CLK Connector × 2	12	VPP Connector
13	SGPIO Connector	14	Sensor Connector
15	Front Backplane Power Connector × 3	16	I ² C Connector × 2
17	SLIM0_CPU1 Connector	18	SLIM1_CPU1 Connector
19	Left Mounting Ear Connector	20	I ² C Connector × 2

Item	Feature	Item	Feature
21	Intrusion Switch Connector	22	SLIM0_CPU0 Connector
23	SLIM1_CPU0 Connector	24	SYS_TF Card Slot
25	Debug Connector	26	SATA Connector × 2
27	B_M.2&3BP&GPU_RISER3 Power Connector	28	Capacitor Board Connector
29	PSU1 Connector	30	GPU Power Connector
31	RAID Key Connector	32	I ² C4_GPU2 Connector
33	PSU0 Connector	34	BMC TF Card Slot
35	PCIe0_CPU0 Slot	36	PCIe0_CPU0 Power Connector
37	NCSI Connector	38	OCPA_CPU0 Slot
39	VGA Port	40	BMC Management Network Port
41	USB 3.0 Port	42	Onboard Network Port
43	PCIe_CPU1 Slot	44	Leak Detection Connector × 2
45	Power Button and LED	46	System/BMC Serial Port
47	UID/BMC RST Button and LED	48	PCIe1_CPU1 Power Connector
49	PCIe0_CPU1 Slot	50	Right Mounting Ear Connector
51	I ² C4_GPU4 Connector	52	I ² C Connector

5.11.2 Drive Backplanes

1. Front Drive Backplanes

Figure 5-54 4 × 3.5-inch SAS/SATA Drive Backplane

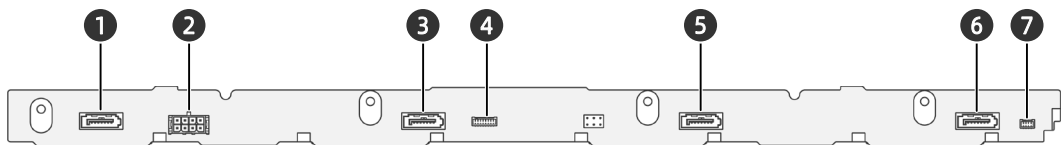

Item	Feature	Item	Feature
1	SATA Connector	2	Power Connector
3	SATA Connector	4	SGPIO Connector
5	SATA Connector	6	SATA Connector
7	I ² C Connector		

Figure 5-55 4 × 3.5-inch SAS/SATA//NVMe Drive Backplane

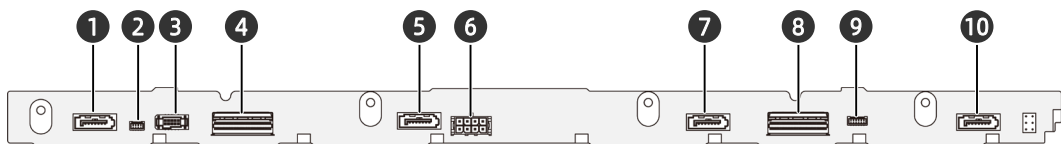

Item	Feature	Item	Feature
1	SATA Connector	2	I ² C Connector
3	VPP Connector	4	Slimline x8 Connector
5	SATA Connector	6	Power Connector
7	SATA Connector	8	Slimline x8 Connector
9	SGPIO Connector	10	SATA Connector

Figure 5-56 2 × M.2 Drive Backplane

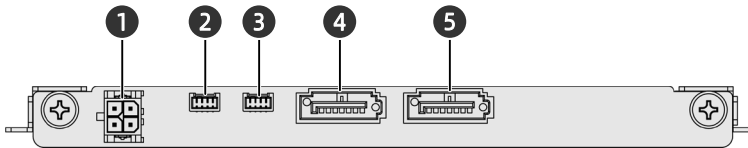

Item	Feature	Item	Feature
1	Power Connector	2	SGPIO Connector
3	I ² C Connector	4	SATA Connector
5	SATA Connector		

Figure 5-57 2 × M.2 Adapter

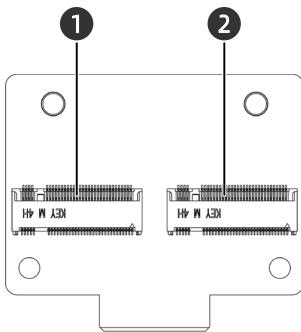

Item	Feature	Item	Feature
1	M.2 SSD Connector 1	2	M.2 SSD Connector 0

Figure 5-58 2 × M.2 SSD + 2 × E1.S SSD Drive Backplane

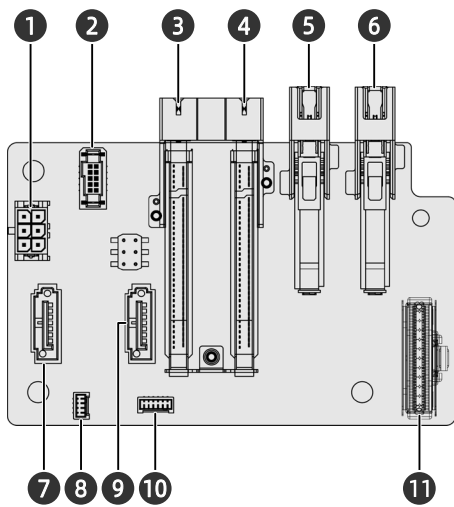

Item	Feature	Item	Feature
1	Power Connector	2	VPP Connector
3	M.2 SSD Connector	4	M.2 SSD Connector
5	E1.S SSD Connector	6	E1.S SSD Connector
7	SATA Connector	8	I ² C Connector
9	SATA Connector	10	SGPIO Connector
11	Slimline x8 Connector		

Figure 5-59 12 × 2.5- inch SAS/SATA/NVMe Drive Backplane

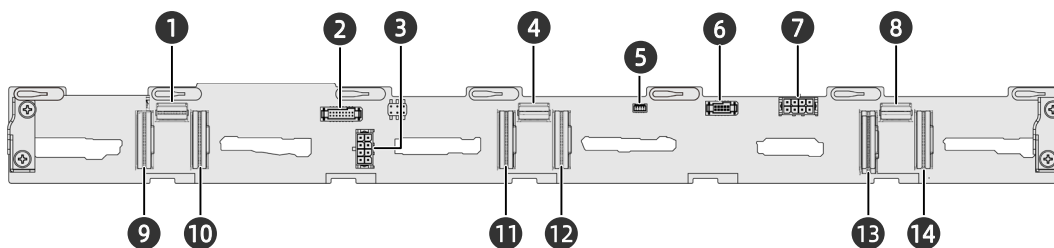

Item	Feature	Item	Feature
1	Slimline x4 Connector	2	Front Control Panel Connector
3	Power Connector	4	Slimline x4 Connector
5	I ² C Connector	6	VPP Connector
7	Power Connector	8	Slimline x4 Connector
9	Slimline x8 Connector	10	Slimline x8 Connector
11	Slimline x8 Connector	12	Slimline x8 Connector
13	Slimline x8 Connector	14	Slimline x8 Connector

Figure 5-60 2 × E1.5 SSD Drive Backplane

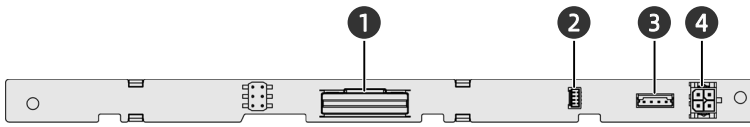

Item	Feature	Item	Feature
1	Slimline x8 Connector	2	I ² C Connector
3	VPP Connector	4	Power Connector

Figure 5-61 2 × SAS/SATA Drive Backplane

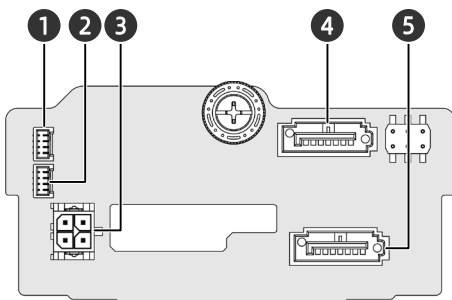

Item	Feature	Item	Feature
1	SGPIO Connector	2	I ² C Connector
3	Power Connector	4	SATA Connector
5	SATA Connector		

Figure 5-62 8 × 2.5-inch SAS/SATA Drive Backplane

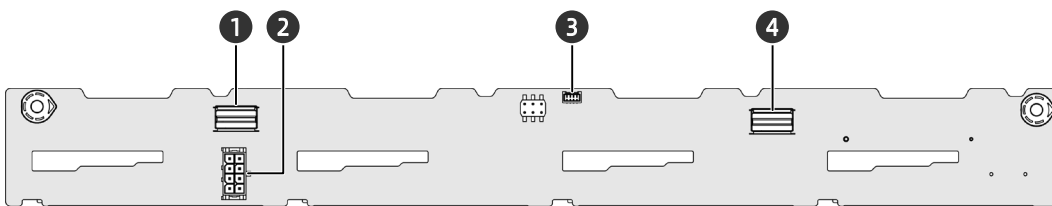

Item	Feature	Item	Feature
1	Slimline x4 Connector	2	Power Connector
3	I ² C Connector	4	Slimline x4 Connector

Figure 5-63 8 × 2.5-inch SAS/SATA/NVMe Drive Backplane

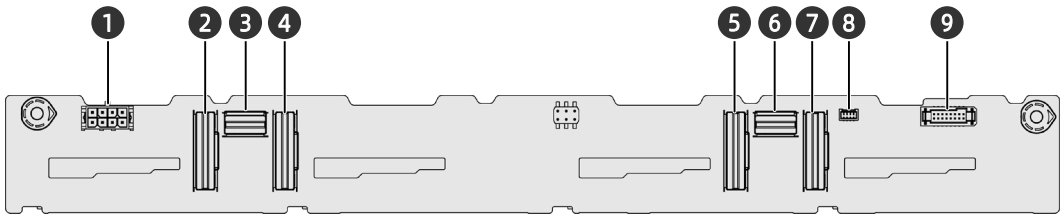

Item	Feature	Item	Feature
1	Power Connector	2	Slimline x8 Connector
3	Slimline x4 Connector	4	Slimline x8 Connector
5	Slimline x8 Connector	6	Slimline x4 Connector
7	Slimline x8 Connector	8	I ² C Connector
9	VPP Connector		

Figure 5-64 2 × 2.5-inch NVMe Drive Backplane

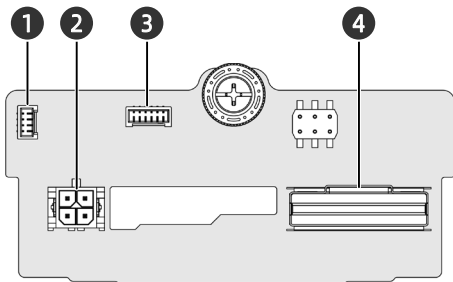

Item	Feature	Item	Feature
1	I ² C Connector	2	Power Connector
3	VPP Connector	4	Slimline x8 Connector

Figure 5-65 32 × E1.S SSD Drive Backplane

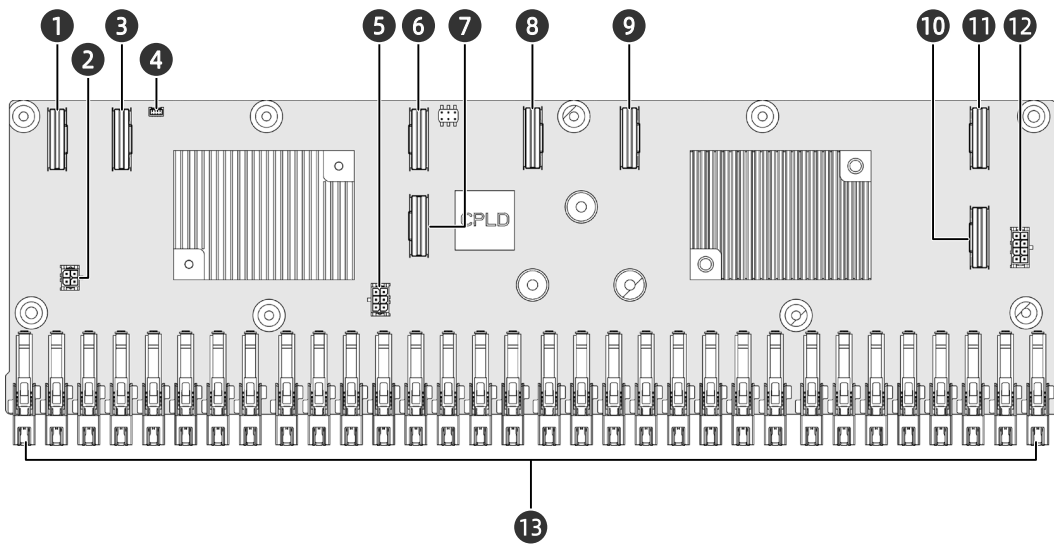

Item	Feature	Item	Feature
1	Slimline x8 Connector	2	Power Connector
3	Slimline x8 Connector	4	I ² C Connector
5	Power Connector	6	Slimline x8 Connector
7	Slimline x8 Connector	8	Slimline x8 Connector
9	Slimline x8 Connector	10	Slimline x8 Connector
11	Slimline x8 Connector	12	Connector
13	E1.S SSD Connector × 32		

Figure 5-66 2 × 2.5-inch SAS/SATA Drive Backplane

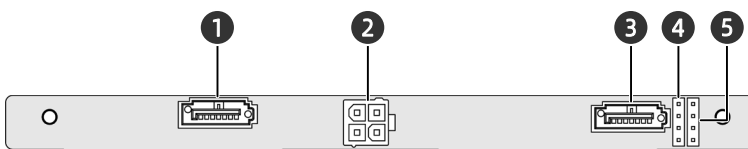

Item	Feature	Item	Feature
1	SATA Connector	2	Power Connector
3	SATA Connector	4	SGPIO Connector
5	I ² C Connector		

Figure 5-67 4 × 2.5-inch SAS/SATA/NVMe Drive Backplane

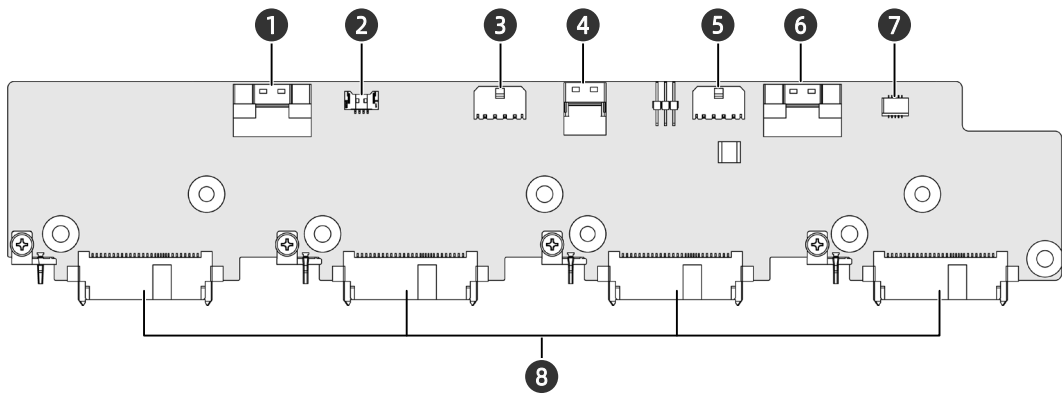

Item	Feature	Item	Feature
1	Slimline x8 Connector	2	I ² C Connector
3	Power Connector	4	Slimline x4 Connector
5	Power Connector	6	Slimline x8 Connector
7	VPP Connector	8	SFF8639 Connector × 4

2. Internal Drive Backplane

Figure 5-68 2 × M.2 Adapter

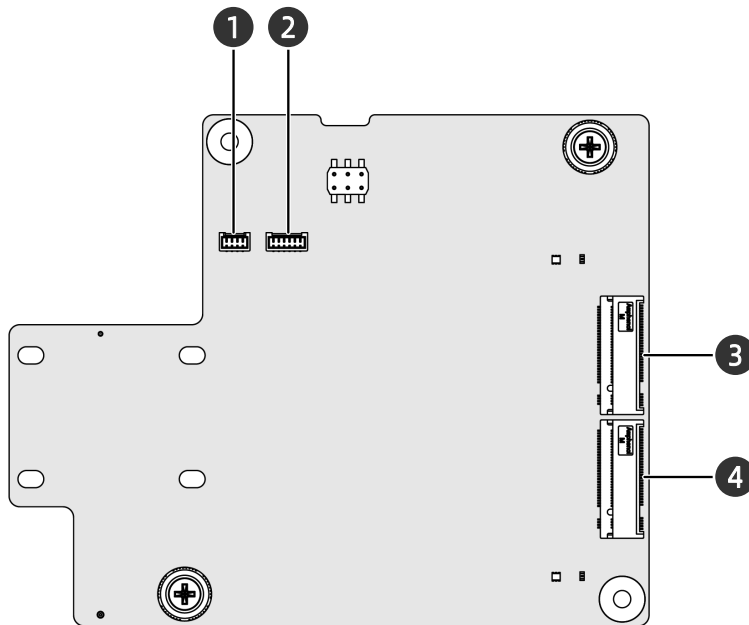

Item	Feature	Item	Feature
1	I ² C Connector	2	VPP Connector
3	M.2 SSD Connector	4	M.2 SSD Connector

6 Product Specifications

6.1 Technical Specifications

Table 6-1 Technical Specifications

Item	Description
Form Factor	1U rack server
Processor	<ul style="list-style-type: none"> • 1 to 2 Intel Xeon Scalable processors of 6300, 8300, 5300 or 4300 series • Up to 40 cores (base frequency at 2.3 GHz) • Max. base frequency at 3.6 GHz (8 cores) • 3 UPI links at up to 11.2 GT/s • L3 cache up to 1.5 MB per core • TDP up to 270 W
Chipset	Intel C621A
Memory	<ul style="list-style-type: none"> • Up to 32 DIMMs • 8 memory channels per CPU with up to 2 DIMM slots per channel • Up to 3,200 MT/s • RDIMMs and Optane PMem 200 series supported • ECC, memory mirroring and memory rank sparing
Storage	<p>Front panel:</p> <ul style="list-style-type: none"> • 12 × 2.5-inch SATA/SAS/NVMe drive (hot-swap, up to 12 × NVMe drive) • 32 × E1.S SSD (hot-swap) • 4 × 3.5-inch SAS/SATA/NVMe drive + 2 × M.2 SSD + 2 × E1.S SSD (M.2 SSDs are non-hot-swap) • 4 × 3.5-inch SAS/SATA/NVMe drive + 4 × 2.5-inch SAS/SATA/NVMe drive (hot-swap) • 10 × 2.5-inch SAS/SATA/NVMe drive (hot-swap) • 8 × 2.5-inch SAS/SATA/NVMe drive + 2 × E1.S SSD + 2 × M.2 SSD (M.2 SSDs are non-hot-swap) <p>Rear panel:</p> <ul style="list-style-type: none"> • 2 × 2.5-inch SAS/SATA drive (hot-swap) <p>Internal storage:</p> <ul style="list-style-type: none"> • Up to 2 × TF card, 1 for BIOS and BMC respectively • Up to 2 × SATA M.2 SSD

Item	Description
	<ul style="list-style-type: none"> Up to 2 × PCIe x4 M.2 SSD
Storage Controller	<ul style="list-style-type: none"> RAID controller cards SAS controller cards The onboard PCH supports 14 × SATA connector (2 × SATA 7-pin connector + 3 × MiniSAS HD connector) Onboard Intel NVMe controllers (1 optional Intel NVMe RAID key)
Network	<ul style="list-style-type: none"> 1 optional OCP 3.0 card module (1/10/25/40/100 Gb) A pair of onboard 10 Gb network ports (optional) A pair of onboard 1 Gb network ports (optional) Standard PCIe NICs of 1/10/25/40/100 Gb
I/O Expansion	<ul style="list-style-type: none"> Up to 3 standard PCIe 4.0 x16 cards, 1 OCP 3.0 card and 1 optional PCIe x8 mezz card 2 standard PCIe 4.0 x16 cards for single-CPU configuration
Port	<p>Front:</p> <ul style="list-style-type: none"> 1 × USB 3.0 port 1 × USB 2.0 port 1 × VGA port <p>Rear:</p> <ul style="list-style-type: none"> 2 × USB 3.0 port 1 × VGA port 1 × BMC/system serial port
Fan	8 hot-swap 4056 fans in N+1 redundancy
Power Supply	<p>PSUs of 550/800/1,300 W or above with 1+1 redundancy</p> <ul style="list-style-type: none"> 110 Vac - 230 Vac: 90 V to 264 V 240 Vdc: 180 V to 320 V 336 Vdc: 260 V to 400 V -48 Vdc: -40 V to -72 V
System Management	Integrated with 1 independent 1,000 Mbps network port, dedicated to IPMI remote management
Operating System	<ul style="list-style-type: none"> Microsoft Windows Server 2008/2012/2016/2019 Red Hat Enterprise Linux 6/7/8 SUSE Linux Enterprise Server 11/12

6.2 Environmental Specifications

Table 6-2 Environmental Specifications

Item	Parameter
Temperature ^{1, 2, 3}	<ul style="list-style-type: none"> Operating: 5°C to 45°C (41°F to 113°F)

Item	Parameter
	<ul style="list-style-type: none"> • Storage (packed): -40°C to +70°C (-40°F to +158°F) • Storage (unpacked): -40°C to +55°C (-40°F to +131°F)
Relative Humidity (RH, non-condensing)	<ul style="list-style-type: none"> • Operating: 5% to 90% RH • Storage (packed): 5% to 93% RH • Storage (unpacked): 5% to 93% RH
Operating Altitude	<p>≤ 3,050 m (10,007 ft)</p> <ul style="list-style-type: none"> • 0 - 1,000 m (0 - 3,281 ft): The operating temperature ranges from 0°C to 40°C (32°F to 104°F). • 1,000 - 3,050 m (3,281 - 10,007 ft): The operating temperature ranges from 5°C to 32°C (41°F to 89.6°F).
Corrosive Airborne Contaminants	<p>Maximum growth rate of corrosion film thickness:</p> <ul style="list-style-type: none"> • Copper coupon: 300 Å/month (compliant with the gaseous corrosivity level of G1 defined in ANSI/ISA-71.04-2013) • Silver coupon: 200 Å/month (compliant with the gaseous corrosivity level of G1 defined in ANSI/ISA-71.04-2013)
Noise ^{4,5,6}	<p>Noise emissions are measured in accordance with ISO 7779 (ECMA 74) and declared in accordance with ISO 9296 (ECMA 109). Listed are the declared A-Weighted sound power levels (LWAd) and the declared average bystander position A-weighted sound pressure levels (LpAm) at a server operating temperature of 23°C (73.4°F):</p> <ul style="list-style-type: none"> • Idle: <ul style="list-style-type: none"> - LWAd: 5.8 B for standard configurations - LpAm: 49 dBA for standard configurations • Operating: <ul style="list-style-type: none"> - LWAd: 6.4 B for standard configurations

Item	Parameter
	- LpAm: 53 dBA for standard configurations

Notes:

1. Not all configurations support an operating temperature range of 5°C to 45°C (41°F to 113°F). The GPU configuration supports an operating temperature range of 10°C to 30°C (50°F to 86°F).
2. Standard operating temperature:
 - For temperatures between 10°C and 35°C (50°F and 95°F), de-rate the maximum allowable temperature by 1°C per 305 m (1°F per 556 ft) above sea level. Please keep the product away from direct sunlight. The maximum temperature gradient is 20°C/h (36°F/h) and the maximum operating altitude is 3,050 m (10,007 ft), both varying with server configuration.
 - Any fan failure or operations above 30°C (86°F) may lead to system performance degradation.
3. Expanded operating temperature:
 - As for certain approved configurations, the supported system inlet ambient temperature can be expanded to 5°C to 10°C (41°F to 50°F) and 35°C to 45°C (95°F to 113°F) at sea level. At an altitude of 900 to 3,050 m (2,953 to 10,007 ft), de-rate the maximum allowable operating temperature by 1°C per 175 m (1°F per 319 ft).
 - As for certain approved configurations, the supported system inlet ambient temperature can be expanded to 35°C to 45°C (95°F to 113°F) at sea level. At an altitude of 900 to 3,050 m (2,953 to 10,007 ft), de-rate the maximum allowable temperature by 1°C per 125 m (1°F per 228 ft).
 - Any fan failure or operations under expanded environments may lead to system performance degradation.
4. This document lists the LWAd and LpAm of the product at a 23°C (73.4°F) ambient environment. All measurements are conducted in conformance with ISO 7779 (ECMA 74) and declared in conformance with ISO 9296 (ECMA 109). The listed sound levels apply to the standard configuration. Additional options may result in increased sound levels. Contact your sales representative for more information.
5. The sound levels shown here were measured based on the specific configuration of a server. Sound levels vary with server configuration. These values are for reference only and subject to change without notice.

6. Product conformance to cited normative standards is based on sample testing, evaluation, or assessment. This product or family of products is eligible to bear the appropriate compliance logos and statements.

6.3 Physical Specifications

Table 6-3 Physical Specifications

Item	Description
Chassis Dimensions (W × H × D)	Standard configurations <ul style="list-style-type: none"> • With mounting ears: 482 × 43.05 × 811.8 mm (18.98 × 1.69 × 31.96 in.) • Without mounting ears: 438 × 43.05 × 780 mm (17.24 × 1.69 × 30.71 in.) 32 × E1.S configuration <ul style="list-style-type: none"> • With mounting ears: 482 × 43.05 × 871.8 mm (18.98 × 1.69 × 34.32 in.) • Without mounting ears: 438 × 43.05 × 840 mm (17.24 × 1.69 × 33.07 in.)
Outer Packaging Dimensions (L × W × H)	<ul style="list-style-type: none"> • 780-depth chassis: 1,031 × 651 × 247 mm (40.59 × 25.63 × 9.72 in.) • 840-depth chassis: 1,080 × 600 × 240 mm (42.52 × 23.62 × 9.45 in.)
Weight (Mainstream Configuration)	4 × 3.5-inch drive configuration (rear 2.5-inch drives included) <ul style="list-style-type: none"> • Net weight (unpacked): approx. 21 kg (46.30 lbs) • Gross weight (including chassis, packaging, rails, and accessory box): 31.5 kg (69.45 lbs) 10 × 2.5-inch drive configuration (rear 2.5-inch drives included) <ul style="list-style-type: none"> • Net weight (unpacked): approx. 21 kg (46.30 lbs) • Gross weight (including chassis, packaging, rails, and accessory box): 31 kg (68.34 lbs)

7 Operating System and Hardware Compatibility

This chapter describes the OS and hardware compatibility of the NF5180M6. For the latest compatibility configuration and the component models not listed in this document, contact your local sales representative.

i IMPORTANT

- Using incompatible components may cause the server to work abnormally, and such failures are not covered by technical support or warranty.
- The server performance is strongly influenced by application software, middleware and hardware. The subtle differences in them may lead to performance variation in the application and test software.
 - For requirements on the performance of specific application software, contact your sales representatives to confirm the detailed hardware and software configurations during the pre-sales phase.
 - For requirements on hardware performance consistency, define specific configuration requirements (for example, specific drive models, RAID controller cards, or firmware versions) during the pre-sales phase.

7.1 Supported Operating Systems

Table 7-1 Supported Operating Systems

OS	Version
Windows	Windows Server 2019
Red Hat	Red Hat Enterprise Linux 7.9
	Red Hat Enterprise Linux 8.2
	Red Hat Enterprise Linux 8.3
SUSE	SLES 12.5
	SLES 15.2
CentOS	CentOS 7.9
	CentOS 8.2
	CentOS 8.3
VMware ESXi	VMware ESXi 7.0

OS	Version
	VMware ESXi 7.0U1
Ubuntu	Ubuntu 18.04.05
	Ubuntu 20.04
	Ubuntu 20.04.1

7.2 Hardware Compatibility

7.2.1 CPU Specifications

The NF5180M6 supports up to 2 Intel Xeon Scalable processors.

Table 7-2 CPU Specifications

Model	Cores	Base Frequency (GHz)	Cache	TDP (W)
CPU_I_6314U-Xeon2.3_32C_48M_205W-D2	32	2.3	48MB	205
CPU_I_6346-Xeon3.1_16C_24M_205W-D2	16	3.1	24MB	205
CPU_I_6354-Xeon3.0_18C_27M_205W-D2	18	3.0	39MB	205
CPU_I_6330-Xeon2_28C_42M_205W-D2	28	2.0	42MB	205
CPU_I_6348-Xeon2.6_28C_42M_235W-D2	28	2.6	42MB	235
CPU_I_6338-Xeon2.0_32C_48M_205W-D2	32	2.0	48MB	205
CPU_I_6330N-Xeon2.2_28C_42M_165W-D2	28	2.2	42MB	165
CPU_I_6338N-Xeon2.2_32C_48M_185W-D2	32	2.2	48MB	185
CPU_I_8380-Xeon2.3_40C_60M_270W-D2	40	2.3	60MB	270
CPU_I_8352V-Xeon2.1_36C_54M_195W-D2	36	2.1	54MB	195
CPU_I_8360Y-Xeon2.4_36C_54M_250W-D2	36	2.4	54MB	250
CPU_I_8358-Xeon2.6_32C_48M_250W-D2	32	2.6	48MB	250
CPU_I_8352Y-Xeon2.2_32C_48M_205W-D2	32	2.2	48MB	205
CPU_I_8358P-Xeon2.6_32C_48M_240W-D2	32	2.6	48MB	240
Ice Lake SP HCC Intel(R) Xeon(R) Silver 4310 12c 120W 2.1GHz M-1 QS QXRN	12	2.1	18MB	120
Ice Lake SP HCC Intel(R) Xeon(R) Silver 4314 16c 135W 2.4GHz M-1 QS QXS8	16	2.4	24MB	135
Ice Lake SP HCC Intel(R) Xeon(R) Silver 4316 20c 150W 2.3GHz M-1 QS QXS5	20	2.3	30MB	150
Ice Lake SP HCC Intel(R) Xeon(R) Gold 5317 12c 150W 3.0GHz M-1 QS QXRM	12	3.0	18MB	150
Ice Lake SP HCC Intel(R) Xeon(R) Gold 5320 26c 185W 2.2GHz M-1 QS QXRT	26	2.2	39MB	185
Ice Lake SP HCC Intel(R) Xeon(R) Gold 6334 8c 165W 3.6GHz M-1 QS QXRQ	8	3.6	18MB	165

Model	Cores	Base Frequency (GHz)	Cache	TDP (W)
Ice Lake SP HCC Intel(R) Xeon(R) Silver 4309Y 8c 105W 2.8GHz M-1 QS QXRS	8	2.8	12MB	105
Ice Lake SP HCC Intel(R) Xeon(R) Silver 4310T 10c 105W 2.3GHz M-1 QS QXRP	10	2.3	15MB	105
Ice Lake SP HCC Intel(R) Xeon(R) Gold 5315Y 8c 140W 3.2GHz M-1 QS QXRR	8	3.2	12MB	140
Ice Lake SP HCC Intel(R) Xeon(R) Gold 5318N 24c 150W 2.1GHz M-1 QS QXS4	24	2.1	36MB	150
Ice Lake SP HCC Intel(R) Xeon(R) Gold 5318Y 24c 165W 2.1GHz M-1 QS QXS2	24	2.1	36MB	165

7.2.2 Memory Specifications

The NF5180M6 supports up to 32 DDR4 DIMMs. Each processor supports 8 memory channels with 2 DIMM slots per memory channel. The server supports RDIMM/Optane PMem 200 series.

Table 7-3 Memory Specifications

DIMM Type	Capacity (GB)	Frequency (MHz)	Data Width	Organization
RDIMM	16	3,200	x72	1R x4/2R x8
RDIMM	16	2,933	x72	1R x4/2R x8
RDIMM	32	3,200	x72	2R x4
RDIMM	32	2,933	x72	2R x4
RDIMM	64	3,200	x72	2R x4
RDIMM	64	2,933	x72	2R x4
BPS	128	3,200	-	-
BPS	256	3,200	-	-
BPS	512	3,200	-	-

7.2.3 Drive Specifications

Table 7-4 Drive Options 1

Type	Model	Capacity
2.5-inch SATA SSD	S4510	240 GB/480 GB/960 GB/1.92 TB/7.68 TB
	PM883	240 GB/480 GB/960 GB/1.92 TB/3.84 TB
	5300PRO	240 GB/480 GB/960 GB/1.92 TB/3.84 TB/7.68 TB

Type	Model	Capacity
	S4610	240 GB/480 GB/960 GB/1.92 TB/3.84 TB/7.68 TB
	SM883	240 GB/480 GB/960 GB/1.92 TB/3.84 TB

Table 7-5 Drive Options 2

Type	Manufacturer	Capacity
2.5-inch SAS HDD	Seagate	600 GB/1.2 TB/1.8 TB/2.4 TB
	Toshiba	600 GB/1.2 TB/1.8 TB/2.4 TB

Table 7-6 Drive Options 3

Type	Manufacturer	Capacity
3.5-inch SATA HDD	Seagate	2 TB/4 TB/6 TB/8 TB/10 TB/12 TB/14 TB/16 TB
	Toshiba	6 TB/8 TB/10 TB/12 TB/14 TB
	HGST	4 TB/6 TB/8 TB/10 TB/12 TB/14 TB/16 TB/18 TB

7.2.4 SAS/RAID Controller Card Specifications

Table 7-7 RAID/SAS Controller Card Specifications

Type	Description	Support for Battery Pack
SAS Controller Card	SAS Controller Card_L_8R0_3408IMR_HDM12G_PCl3_Mezz	No
	SAS Controller Card_PM8222_SmarHBA_8_SAS3_PCl3	No
	SAS Controller Card_L_8R0_9400-8i_HDM12G_PCl3	No
	SAS Controller Card_L_8R0_3408IT_HDM12G_PCl3_Mezz	No
	SAS Controller Card_PM8222_PM8222_8_SAS3_PCl3	No
	PM8252 8i SAS Controller Card_PM8252_HBA_8_SAS4_PCl4	No
RAID Controller Card	RAID Controller Card_PM8204_RA_8_2GB_SAS3_PCl3	Yes
	RAID Controller Card_L_8R0_9460-8i_2GB_HDM12G_PCl3	Yes

Type	Description	Support for Battery Pack
	RAID Controller Card_L_16R0_9460-16i_4GB_HDM12G_PClE3	No
	RAID Controller Card_L_8R0_3508_4GB_HDM12G_PClE3_Mezz	No
	RAID Controller Card_L_8R0_9361-8i_1G_HDM12G_PClE3	Yes
	RAID Controller Card_L_8R0_9361-8i_2G_HDM12G_PClE3	No

7.2.5 NIC Specifications

Table 7-8 OCP 3.0 Card Specifications

Type	Description	Speed	Network Port Qty
OCP	NIC_SND_10G_X550_RJ_OCP3x4_2_XR	10G	2
	NIC_M_100G_MCX566A_LC_OCP3x16_2_XR	100G	2
	NIC_I_25G_E810-XXVDA2_LC_OCP3x8_2_XR	25G	2
	NIC_M_100G_MCX566ACDAB_LC_OCP3x16_2_XR	100G	2
	NIC_BRCM_25G_57414_LC_OCP3x8_2_XR	25G	2
	NIC_M_25G_MCX631432A_LC_OCP3x8_2_XR	25G	2

Table 7-9 Standard PCIe NIC Specifications

Type	Description	Speed	Network Port Qty
PCIe NIC	NIC_I_10G_X550T2_RJ_PClE3x4_2_XR	10G	2
	NIC_I_10G_X710DA2_LC_PClE3x8_2_XR	10G	2
	NIC_I_25G_E810-XXVDA2_LC_PClE3x8_2_XR	25G	2
	NIC_I_40G_XL710_LC_PClE3x8_2_MM	40G	2
	NIC_M_25G_MCX512A-ACAT_LC_PClE3x8_2_XR	25G	2
	NIC_82599ES_10G_LC_PClE3x8_Dual_XR_Daughter Card	10G	2
	NIC_W_I350AM4_1G_RJ45_PClE3x8_Quad	1G Base-T	4
	NIC_SND_W_I350-AM2_RJ_PClE3-E4X_1KM_Dual	1G Base-T	2
	NIC_I_100G_E810-CQDA2_LC_PClE3x16_2_XR	100G	2

Type	Description	Speed	Network Port Qty
	NIC_M_100G_MCX516A-CCAT_LC_PClx16_2_XR	100G	2
	NIC_82599ES_10G_LC_PClx8_Dual_XR_Daughter Card	10G	1



NOTE

A server supports up to three 1/10 Gbps PCIe NICs and only one 100 Gbps (or above) NIC.

7.2.6 HBA and HCA Card Specifications

Table 7-10 HCA Card Specifications

Description	Speed	Port Qty
MCX653105A-ECAT PCIe 3.0/4.0 x16 Single Port	100G	1
HCA Card_I_1-EDR4X25_100HFA016LS_PClx16	100G	1
MCX653105A-HDAT PCIe 3.0/4.0 x16	200G	1



NOTE

PCIe x16 is required for an HCA card of over 100 Gbps.

Table 7-11 HBA Card Specifications

Description	Speed
HBA Card_QL_4R1_QLE2690-ISR-BK_FC16G_PClx16	16G
HBA Card_QL_8R2_QLE2742-ISR-BK_FC32G_PClx16	32G
HBA Card_QL_4R2_QLE2692-ISR-BK_FC16G_PClx16	16G

7.2.7 Graphics Card Specifications

Table 7-12 Graphics Card Specifications

Type	Description	Max Qty
Graphics Card	GPU_NV_16GB_Tesla-T4_256b_P/GPU_NV_16G_Tesla-T4_256b_P_Special	2
	GPU_NV_24G_NVIDIA-A10_384b	2

**NOTE**

The graphics card uses PCIe x16 bus, and needs to be inserted into a PCIe x16 slot on the riser card.

7.2.8 PSU Specifications

The PSUs follow the Intel Common Redundant Power Supply (CRPS) specification. The PSUs share a common electrical and structural design that allows for hot-swap and tool-less installation into the server with the PSUs locking automatically after being inserted into the power bay. Up to 2 PSUs in 1+1 redundancy are supported. The PSUs are 80 Plus Platinum certified. The server offers various output powers, allowing customers to choose based on the actual configuration.

- The following PSUs in 1+1 redundancy with the rated input voltage of 110 V to 230 Vac and 240 Vdc are supported:
 - 550 W Platinum PSUs: 550 W (110 Vac), 550 W (230 Vac), 550 W (240 Vdc for China)
 - 800 W Platinum PSUs: 800 W (110 Vac), 800 W (230 Vac), 800 W (240 Vdc for China)
 - 1,300 W Platinum PSUs: 1,000 W (110 Vac), 1,300 W (230 Vac), 1,300 W (240 Vdc for China)
 - 800 W Titanium PSUs: 800 W (110 Vac), 800 W (230 Vac), 800 W (240 Vdc for China)
 - 1,300 W Titanium PSUs: 1,000 W (110 Vac), 1,300 W (230 Vac), 1,300 W (240 Vdc for China)

Input voltage range:

- 110 Vac to 230 Vac: 100 V to 264 V
- 240 Vdc: 180 V to 320 V
- The following PSUs in 1+1 redundancy with the rated input voltage of 336 Vdc are supported:
 - 800 W 336 Vdc PSUs: 800 W (336 Vdc)
 - 1,300 W 336 Vdc PSUs: 1,300 W (336 Vdc)

Input voltage range:

- 336 Vdc: 260 V to 400 V

- The following PSUs in 1+1 redundancy with the rated input voltage of -48 Vdc are supported:

- 800 W -48 Vdc PSU: 800 W (-48 Vdc)
- 1,300 W -48 Vdc PSU: 1,300 W (-48 Vdc)

Input voltage range:

- -48 Vdc: -40 V to -72 V

8 Regulatory Information

8.1 Safety

8.1.1 General

- Strictly comply with local laws and regulations while installing the equipment. The safety instructions in this section are only a supplement to local safety regulations.
- To ensure personal safety and to prevent damage to the equipment, all personnel must strictly observe the safety instructions in this section and on the device labels.
- People performing specialized activities, such as electricians and electric forklift operators, must possess qualifications recognized by the local government or authorities.

8.1.2 Personal Safety

- Only personnel certified or authorized by us are allowed to perform the installation procedures.
- Stop any operation that could cause personal injury or equipment damage. Report to the project manager and take effective protective measures.
- Working during thunderstorms, including but not limited to handling equipment, installing cabinets and installing power cords, is forbidden.
- Do not carry the weight over the maximum load per person allowed by local laws or regulations. Arrange appropriate installation personnel and do not overburden them.
- Installation personnel must wear clean work clothes, work gloves, safety helmets and safety shoes, as shown in [Figure 8-1](#).

Figure 8-1 Protective Clothing



- Before touching the equipment, put on ESD clothes and ESD gloves or an ESD wrist strap, and remove any conductive objects such as wrist watches or metal jewelry, as shown in [Figure 8-2](#), in order to avoid electric shock or burns.

Figure 8-2 Removing Conductive Objects

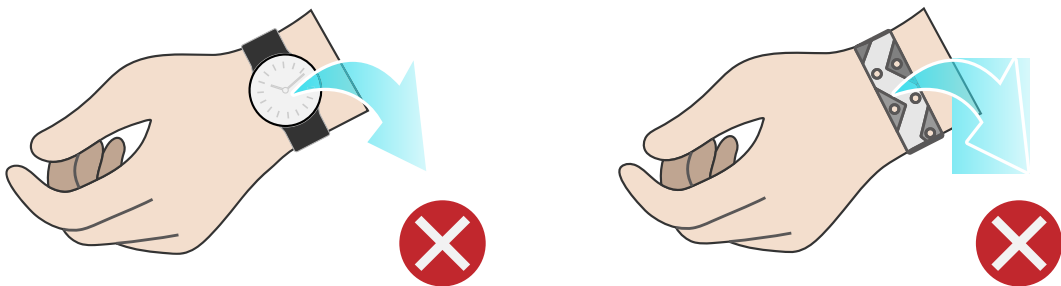

How to put on an ESD strap ([Figure 8-3](#))

1. Put your hand through an ESD wrist strap.
2. Tighten the strap buckle to ensure a snug fit.
3. Plug the alligator clip of the ESD wrist strap into the corresponding jack on the grounded cabinet or grounded chassis.

Figure 8-3 Wearing an ESD Wrist Strap

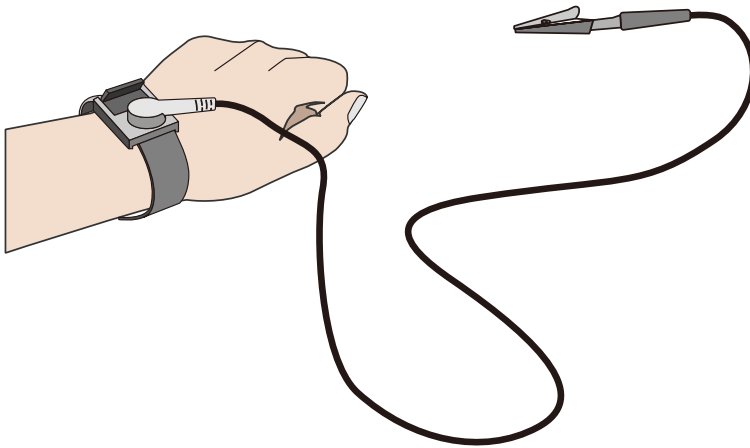

- Use tools correctly to avoid personal injury.
- When moving or lifting equipment above shoulder height, use lifting devices and other tools as necessary to avoid personal injury or equipment damage due to equipment slippage.
- The power sources of the server carry a high voltage. Direct contact or indirect contact through damp objects with the high-voltage power source is fatal.
- To ensure personal safety, ground the server before connecting power.
- When using ladders, always have someone hold and guard the bottom of the ladders. In order to prevent injury, never use a ladder alone.
- When connecting, testing or replacing optical fiber cable, avoid looking into the optical port without eye protection in order to prevent eye damage from laser light.

8.1.3 Equipment Safety

- To ensure personal safety and prevent equipment damage, use only the power cords and cables that come with the server. Do not use them with any other equipment.
- Before touching the equipment, put on ESD clothing and ESD gloves to prevent static electricity from damaging the equipment.
- When moving the server, hold the bottom of the server. Do not hold the handles of any module installed in the server, such as PSUs, fan modules, drive modules, or motherboard. Handle the equipment with care at all times.
- Use tools correctly to avoid damage to the equipment.
- Connect the power cords of active and standby PSUs to different PDUs to ensure high system reliability.

- To ensure equipment safety, always ground the equipment before powering it on.

8.1.4 Transportation Precautions

Contact the manufacturer for precautions before transportation as improper transportation may damage the equipment. The precautions include but not limited to:

- Hire a trusted logistics company to move all equipment. The transportation process must comply with international transportation standards for electronic equipment. Always keep the equipment being transported upright. Avoid collision, moisture, corrosion, packaging damage or contamination.
- Transport the equipment in its original packaging.
- If the original packaging is unavailable, separately package heavy and bulky components (such as chassis, blade servers and blade switches), and fragile components (such as optical modules and PCIe cards).
- Power off all equipment before shipping.

8.1.5 Manual Handling Weight Limits



CAUTION

Observe local laws or regulations regarding the manual handling weight limits per person. The limits shown on the equipment and in the document are recommendations only.

Table 8-1 lists the manual handling weight limits per person specified by some organizations.

Table 8-1 Manual Handling Weight Limit per Person

Organization	Weight Limit (kg/lbs)
European Committee for Standardization (CEN)	25/55.13
International Organization for Standardization (ISO)	25/55.13
National Institute for Occupational Safety and Health (NIOSH)	23/50.72
Health and Safety Executive (HSE)	25/55.13
General Administration of Quality Supervision, Inspection and Quarantine of the People's Republic of China (AQSIQ)	<ul style="list-style-type: none"> • Male: 15/33.08 • Female: 10/22.05

9 Limited Warranty

This limited warranty applies only to the original purchasers of our products who are direct customers or distributors of us (“Customer”).

We warrant all our hardware products, if properly used and installed, to be free from defects in material and workmanship within the warranty period. The term “Hardware Product” is limited to the hardware components and required firmware. The term “Hardware Product” DOES NOT include software applications or programs, and DOES NOT include products, or peripherals that are not supplied by us. We may, at our discretion, repair or replace the defective parts. Repair or replacement parts may be new, used, or equivalent to new in performance and reliability. Repair or replacement parts are warranted to be free of defects in material or workmanship for ninety (90) calendar days or for the remainder of the warranty period of the product, whichever is longer.

Service offerings may vary by geographic region. Please contact your representative to identify service levels and needs for your region.

9.1 Warranty Service

Our warranty service includes 24 × 7 remote technical support, RMA (Return Material Authorization) Service, ARMA (Advanced Return Material Authorization) Service, 9 × 5 × NBD (Next Business Day) Onsite Service and 24 × 7 × 4 Onsite Service.

9.1.1 Remote Technical Support

The 24 × 7 remote technical support can be obtained through hotline, e-mail, and Service Portal*¹. Through hotline and e-mail support, our engineers help customers diagnose the causes of malfunctions and provide solutions. Service Portal*¹ provides access to firmware, customized update files, and related manuals for Hardware Products. Customer may also access the Service Portal*¹ to submit an RMA request or an ARMA request for parts replacement or repair.

Information needed when requesting support:

- Contact name, phone number, e-mail address
- System serial number, part number, model and location (address) of the product needing service
- Detailed description of problem, logs (SEs and blackbox logs, and any other related logs from OS), screenshot of issue, pictures of damaged/faulty parts, etc.

9.1.2 RMA Service

Standard Replacement: When a hardware failure occurs, Customer may submit an RMA request to us via e-mail or Service Portal*¹. We will review and approve the RMA submission at our own discretion, and provide an RMA number and return information that Customer may use to return the defective part(s) for the RMA service. We will ship out replacement part(s) within one (1) business day after receiving the defective part(s) and cover one-way shipment.



- Customer should return the defective parts in proper packaging to our designated service center at their own expense.
 - After our further diagnosing and testing, if the defective parts conform to our repair policy, we will ship out the repair or replacement parts at our own expense; otherwise, we will return the defective parts at Customer's expense.
 - If Customer needs to designate a logistics company, allocation of the shipping cost to us/Customer will be redefined.
-

9.1.3 ARMA Service

Advanced Replacement: If a problem with our hardware products cannot be resolved via hotline or e-mail support and replacement part(s) are required, we will ship out replacement part(s) in advance within one (1) business day. Customer should return defective part(s) within five (5) business days after receiving the replacement(s). The shipping cost coverage varies by region. Contact your sales representative for details.



- Customer should return the defective parts in proper packaging to our designated service center.
 - We will ship out the replacement parts at our own expense after completing remote diagnosis.
 - If Customer needs to designate a logistics company, allocation of the shipping cost to us/Customer will be redefined.
-

9.1.4 9 × 5 × NBD Onsite Service

When we ultimately determines that an onsite service call is required to repair or replace a defect, the call will be scheduled in accordance with the Response Time

Commitment. The response time is measured from the time when the remote troubleshooting is completed and logged to the arrival of a service engineer and parts to Customer location for repair.



NOTE

9 × 5 × NBD: Our service engineer typically arrives at the customer's data center on the next business day. Service engineers are available on local business day from 9:00 am to 6:00 pm local time. Calls received/dispatches after 5:00 pm local time will require an additional day for the service engineer to arrive.

9.1.5 24 × 7 × 4 Onsite Service

When we ultimately determine that an onsite service call is required to repair or replace a defect, the call will be scheduled in accordance with the Response Time Commitment. The response time is measured from the time when the remote troubleshooting is completed and logged to the arrival of a service engineer and parts to Customer location for repair.



NOTE

24 × 7 × 4: Our service engineer typically arrives at the customer site within 4 hours. Service engineers are available at any time, including weekends and local national holidays.

9.2 Our Service SLA

We offer a variety of Service Level Agreements (SLA)*² to meet customer requirements.

- RMA Service
- ARMA Service
- 9 × 5 × NBD Onsite Service
- 24 × 7 × 4 Onsite Service

9.3 Warranty Exclusions

We do not guarantee that there will be no interruptions or mistakes during the use of the products. We will not undertake any responsibility for the losses arising from any operation not conducted according to instructions intended for Hardware Products.

The Limited Warranty does not apply to

- expendable or consumable parts, such as, but not limited to, batteries or protective coatings that are designed to diminish over time, unless failure has occurred during DOA period due to a defect in material or workmanship;
- any cosmetic damage, such as, but not limited to, scratches, dents, broken plastics, metal corrosion, or mechanical damage, unless failure has occurred during DOA period due to a defect in material or workmanship;
- damage or defects caused by accident, misuse, abuse, contamination, improper or inadequate maintenance or calibration or other external causes;
- damage or defects caused by operation beyond the parameters as stipulated in the user documentation;
- damage or defects by software, interfacing, parts or supplies not provided by us;
- damage or defects by improper storage, usage, or maintenance;
- damage or defects by virus infection;
- loss or damage in transit which is not arranged by us;
- Hardware Products that have been modified or serviced by non-authorized personnel;
- any damage to or loss of any personal data, programs, or removable storage media;
- the restoration or reinstallation of any data or programs except the software installed by us when the product is manufactured;
- any engineering sample, evaluation unit, or non-mass production product that is not covered under warranty service;
- any solid-state drive (SSD) which has reached its write endurance limit.

In no event will we be liable for any direct loss of use, interruption of business, lost profits, lost data, or indirect, special, incidental or consequential damages of any kind regardless of the form of action, whether in contract, tort (including negligence), strict liability or otherwise, even if we have been advised of the possibility of such damage, and whether or not any remedy provided should fail of its essential purpose.

*1 Service Portal availability is subject to customer type and customer location. Please contact your representative to learn more.

*2 Not all SLA offerings are available at all customer locations. Some SLA offerings may be limited to geolocation and/or customer type. Please contact your representative to learn more.

10 System Management

10.1 Intelligent Management System ISBMC

ISBMC, a remote server management system, supports mainstream management specifications in the industry such as IPMI 2.0 and Redfish 1.8. ISBMC features high operational reliability, easy serviceability for different business scenarios, accurate and comprehensive fault diagnosis capabilities, and industry-leading security reinforcement capabilities.

ISBMC supports:

- IPMI 2.0
- Redfish 1.8
- SNMP v1/v2c/v3
- HTML5/Java remote consoles (Keyboard Video Mouse)
- remote virtual media
- login on web browsers
- intelligent fault diagnosis

Table 10-1 ISBMC Features

Feature	Description
Management Interface	Supports extensive remote management interfaces for various server O&M scenarios. The supported interfaces include: <ul style="list-style-type: none">● IPMI● SSH CLI● SNMP● HTTPS● Web GUI● Redfish● RESTful● DCMI● Syslog

Feature	Description
Accurate and Intelligent Fault Location	IDL, a fault diagnosis system, offers accurate and comprehensive hardware fault location capabilities, and outputs detailed fault causes and handling suggestions.
Alert Management	Supports rich automatic remote alert capabilities, including proactive alerting mechanisms such as SNMP Trap (v1/v2c/v3), email alerts and syslog remote alerts to ensure 24 × 7 reliability.
Remote Console KVM	Supports HTML5- and Java-based remote console to remotely control and operate the monitor/mouse/keyboard of the server, providing highly available remote management capabilities without on-site operation.
Virtual Network Console (VNC)	Supports mainstream third-party VNC clients without relying on Java, improving management flexibility.
Remote Virtual Media	Supports virtualizing images, USB devices, folders and local media devices as media devices of remote servers, simplifying OS installation, file sharing, and other O&M tasks.
Web GUI	Supports the visual management interface developed by us, displaying abundant information of the server and components, and offers easy-to-use Web GUIs.
Crash Screenshot and Manual Screenshot	<ul style="list-style-type: none"> • Supports automatic crash screenshot with the last screen before crash saved; • Provides manual screenshot, which can quickly capture the screen for easy inspection at scheduled time.
Dual Flash and Dual Image	Supports dual flash and dual image, enabling automatic flash failover in case of software or flash corruption, improving operational reliability.
Power Capping	Supports power capping, increasing deployment density and reducing energy consumption.
IPv4/IPv6	Supports both IPv4 and IPv6, enhancing network deployment flexibility.
Auto-Switching of Management Network Port	Supports auto-switching between the dedicated management network port and shared management network port, providing customers with flexible network deployment solutions for different management network deployment scenarios.
ISBMC Self-Diagnosis and Self-Recovery System	<ul style="list-style-type: none"> • Supports the reliable dual watchdog mechanism for hardware and software, enabling automatic restoration of BMC in case of BMC abnormality.

Feature	Description
	<ul style="list-style-type: none"> Provides a thermal protection mechanism, which is automatically triggered when the BMC is abnormal to ensure that the fan operates at safe speeds to avoid system overheating Supports self-diagnosis of processors, memory modules, and storage devices of ISBMC, and automatically cleans the workload to restore to normal when the device usage rate is too high.
Power Control	Supports virtual power buttons for power on/off, power cycle and reset.
UID LED	Supports remote lighting of the UID LED for locating the server in the server room, and supports remote control of UID LED.
Secure Firmware Update	<ul style="list-style-type: none"> Supports firmware update based on secure digital signatures, mismatch prevention mechanism for firmware from different manufacturers and firmware for different server models; Supports firmware update of BMC/BIOS/CPLD/PSU.
Serial Port Redirection	Supports remote redirection of the system serial port, BMC serial port and other serial ports, and directs the server-side serial port output to the local administrator via the network for server debugging.
Storage Information Display	Displays RAID logical array information and drive information, supports remote RAID creation for improved deployment efficiency.
User Role Management	Supports user detail management based on user roles and flexible creation of user roles with different privileges, and provides more user roles to allow administrators to grant different privileges to O&M personnel.
Security Feature	Adopts the industry-leading server security baseline standard V2.0. SSH, HTTPS, SNMP and IPMI use secure and reliable algorithms. ISBMC offers capabilities including secure update and boot and security reinforcement mechanisms such as anti-replay, anti-injection, and anti-brute force.

10.2 InManage

The server is compatible with the latest version of InManage, a new-generation infrastructure O&M management platform for data centers.

Built on cutting-edge O&M concepts, InManage provides users with leading and efficient overall management solutions for data centers to ensure advanced infrastructure management. This platform provides a rich set of functions such as centralized asset management, in-depth fault diagnosis, component fault early warning, intelligent energy consumption management, 3D automatic topologies, and stateless automatic deployment. With these functions, users can implement centralized O&M of servers, storage devices, network devices, security devices, and edge devices, effectively improving O&M efficiency, reducing O&M costs, and ensuring the secure, reliable, and stable operation of data centers. InManage offers:

- lightweight deployment in multiple scenarios and full lifecycle management of devices
- high reliability and on-demand scalability enabled by 1 to N data collectors
- intelligent asset management and real-time tracking of asset changes
- comprehensive monitoring for overall business control
- intelligent fault diagnosis for reduced maintenance time
- second-level performance monitoring for real-time status of devices
- batch configuration, deployment and update, shortening the time needed to bring the production environment online
- improved firmware version management efficiency
- standardized northbound interfaces for easy integration and interfacing

Table 10-1 InManage Features

Feature	Description
Home	<ul style="list-style-type: none"> • Display of basic information (data centers, server rooms, cabinets, assets and alerts), quick addition of devices and custom home page

Feature	Description
Assets	<ul style="list-style-type: none"> • Batch asset import, automatic asset discovery, and full lifecycle management of assets • Management of the full range of our server family, including general-purpose rack servers, AI servers, multi-node servers, edge servers and all-in-one servers • Management of our general-purpose disk arrays and distributed storage devices • Management of network devices (switches, routers, etc.), security devices (firewalls, load balancers, etc.), cabinets and clouds • Management of data centers • Asset warranty information management, asset inventory reports for server acceptance, asset attribute expansion, etc.
Monitor	<ul style="list-style-type: none"> • Display of real-time alerts, history alerts, blocked alerts and events • Fault prediction of drives and memories • Custom inspection plan and inspection result management • Notification record viewing • Intelligent fault diagnosis and analysis, automatic fault reporting and repair ticket viewing • Trap management and Redfish management • Management of monitoring rules, such as alert rules, notification rules, blocking rules, alert noise reduction rules, compression rules and fault reporting rules, and redefinition of the above rules.
Control	<ul style="list-style-type: none"> • Quick start of firmware update, OS installation, power management, drive data erasing and stress test • Batch firmware update (BMC/BIOS/RAID Card/NIC/Drive/HBA Card/MB CPLD/BP CPLD/PSU) • Batch firmware configuration (BMC/BIOS)

Feature	Description
	<ul style="list-style-type: none"> • Batch RAID configuration and OS deployment for servers • Secure and quick drive data erasing • CPU and memory stress test • Automatic firmware baseline management • BMC and BIOS snapshot management • Repositories for update files
Energy Efficiency	<ul style="list-style-type: none"> • Overview of data center power consumption trend chart and carbon emission trend chart • Setting of server dynamic power consumption policies and minimum power consumption policies • Server temperature optimization, utilization optimization, power consumption characteristics analysis, power consumption prediction, load distribution, etc. • Carbon asset and carbon emission management
Log	<ul style="list-style-type: none"> • Fault log record management • Diagnosis record and diagnosis rule management
Topologies	<ul style="list-style-type: none"> • Centralized management of multiple data centers and panoramic 3D views, including dynamic display of power consumption, temperature, alerts and cabinet capacity of the data center • Network topologies
Reports	<ul style="list-style-type: none"> • Management of warranty information reports, alert reports, asset reports, hardware reports and performance reports • Export of reports in .xlsx format
System	<ul style="list-style-type: none"> • Password management, alert forwarding and data dump • Customized InManage parameters
Security	Security control of InManage via a set of security policies such as user management, role management, authentication

Feature	Description
	management (local authentication and LDAP authentication) and certificate management.

10.3 InManage Tools

Table 10-2 Features of InManage Tools

Feature	Description
InManage Kits	A lightweight automatic batch O&M tool for servers, mainly used for server deployment, routine maintenance, firmware update, fault handling, etc.
InManage Boot	A unified batch management platform for bare metals, with features including firmware management, hardware configuration, system deployment and migration, stress test and in-band management
InManage Server CLI	Fast integration with third-party management platforms, delivering a new O&M mode of Infrastructure as Code (IaC)
InManage Driver	Operates under the OS and gets system asset and performance information via the in-band mode, providing users with more comprehensive server management capabilities
InManage Server Provisioning	Offers users with RAID configuration, intelligent OS installation, firmware update, hardware diagnosis, secure erasing and software upgrade, using the TF card as the carrier

11 Certifications

Table 11-1 Certifications

Country/Region	Certification	Mandatory/ Voluntary
China	CCC	Mandatory
	CECP	Voluntary
	China Environmental Labelling	Voluntary
International Mutual Recognition	CB	Voluntary
EU	CE	Mandatory
US	FCC	Mandatory
	UL	Voluntary
	Energy Star	Voluntary
Customs Union	EAC	Mandatory
India	BIS	Mandatory
South Korea	E-Standby	Mandatory
	KC	Mandatory
Australia	RCM	Mandatory
Israel	SII	Mandatory
Mexico	NOM	Mandatory

12 Appendix A

12.1 Operating Temperature Specification Restrictions

Table 12-1 Operating Temperature Specification Restrictions

Configuration		Max Temp.	Front Drive	Rear Drive	Optane PMem	CPU	GPU
4 × 3.5-inch Drive + 2 × E1.S SSD + 2 × M.2 SSD Configuration	Rear NIC configuration	35°C (95°F) when all fans are normal and 30°C (86°F) when one fan fails	4 × 3.5-inch drive	N/A	Supported (CPU ≤165 W)	≤205 W	N/A
	Rear GPU configuration		4 × 3.5-inch drive	N/A	Not supported	≤165 W	T4 and other GPUs
	Rear drive configuration		4 × 3.5-inch drive	SSDs supported	Not supported	≤205 W	N/A
10 × 2.5-inch Drive Configuration	Rear NIC configuration	35°C (95°F) when all fans are normal and 30°C (86°F) when one fan fails	8 × 2.5-inch drive	N/A	Supported (CPU ≤165 W)	≤205 W	N/A
	Rear GPU configuration		8 × 2.5-inch drive	N/A	Not supported	≤165 W	T4 and other GPUs
	Rear drive configuration		8 × 2.5-inch drive	SSDs supported	Not supported	≤205 W	N/A
12 × 2.5-inch Drive Configuration	Rear NIC configuration	35°C (95°F) when all fans are normal and 30°C (86°F) when one fan fails	12 × 2.5-inch drive	N/A	Supported (CPU ≤165 W)	≤205 W	N/A
	Rear GPU configuration		12 × 2.5-inch drive	N/A	Not supported	≤165 W	T4 and other GPUs

Configuration		Max Temp.	Front Drive	Rear Drive	Optane PMem	CPU	GPU
	Rear drive configuration		12 × 2.5-inch drive	SSDs supported	Not supported	≤205 W	N/A
32 × E1.S SSD Configuration	Rear NIC configuration	35°C (95°F) when all fans are normal and 30°C (86°F) when one fan fails	32 × E1.S SSD	N/A	Supported (CPU ≤165 W)	≤165 W	N/A
	Rear GPU configuration		32 × E1.S SSD	N/A	Not supported	N/A	T4 and other GPUs
EVAC Heatsink Configuration	Rear NIC configuration	35°C (95°F) when all fans are normal	4 × 2.5-inch drive	N/A	Not supported	>205 W	Not supported
	Rear GPU configuration	30°C (86°F) when all fans are normal	4 × 2.5-inch drive	N/A	Not supported	>205 W	T4 and other GPUs
	Rear drive configuration	35°C (95°F) when all fans are normal	4 × 2.5-inch drive	SSDs supported	Not supported	>205 W	N/A

12.2 Model

Table 12-2 Model

Certified Model	Description
NF5180M6	Global

12.3 RAS Features

The NF5180M6 supports a variety of RAS (Reliability, Availability, and Serviceability) features. By configuring these features, the NF5180M6 can provide greater reliability, availability, and serviceability.

12.4 Sensor List

Table 12-3 Sensor List

Sensor	Description	Sensor Location
Inlet_Temp	Air inlet temperature	Right mounting ear
Outlet_Temp	Air outlet temperature	BMC
PCH_Temp	PCH temperature	Motherboard
CPUn_Temp	CPUn core temperature	CPUn n indicates the CPU number with a value of 0 - 1
CPUn_DTS	CPUn DTS value	CPUn n indicates the CPU number with a value of 0 - 1
CPUn_DIMM_T	CPUn DIMM temperature	DIMM (CPUn) n indicates the CPU number with a value of 0 - 1
PSUn_Temp	PSUn temperature	The corresponding power supply for PSUn n indicates the PSU number with a value of 0 - 1
HDD_MAX_Temp	The maximum temperature among all drives	Drives attached to drive backplane
OCP_NIC_Temp	OCP NIC temperature	OCP NIC
PCle_NIC_Temp	The maximum temperature among all PCIe NIC cards	Motherboard PCIe NIC card
RAID_Temp	The maximum temperature among all RAID controller cards	PCIe RAID controller card
GPU_Temp	The maximum temperature among all GPUs	Motherboard PCIe
NVMe_M.2_Temp	The maximum temperature among all M.2 SSDs	M.2 adapter
SYS_12V	12 V voltage supplied by motherboard to CPU	Motherboard
SYS_5V	5 V voltage supplied by motherboard to BMC	Motherboard
SYS_3V3	3.3 V voltage supplied by motherboard to BMC	Motherboard
CPUn_DDR_VDDQ1	1.2 V DIMM voltage	Motherboard

Sensor	Description	Sensor Location
		n indicates the CPU number with a value of 0 - 1
CPU _n _DDR_VDDQ2	1.2 V DIMM voltage	Motherboard n indicates the CPU number with a value of 0 - 1
CPU _n _Vcore	CPU _n Vcore voltage	Motherboard n indicates the CPU number with a value of 0 - 1
PSU _n _VIN	PSU _n input voltage	Motherboard n indicates the PSU number with a value of 0 - 1
PSU _n _VOUT	PSU _n output voltage	Motherboard n indicates the PSU number with a value of 0 - 1
RTC_Battery	RTC battery voltage	RTC battery on motherboard
FAN _n _Speed	FAN _n speed	FAN _n n indicates the fan module number with a value of 0 - 7
FAN _n _F_Speed		
FAN _n _R_Speed		
Total_Power	Total power	PSU
PSU _n _PIN	PSU _n input power	PSU _n n indicates the PSU number with a value of 0 - 1
PSU _n _POUT	PSU _n output power	PSU _n n indicates the PSU number with a value of 0 - 1
FAN_Power	Total fan power	Fans
CPU_Power	Total CPU power	Motherboard
Memory_Power	Total memory power	Motherboard
Disk_Power	Total drive power	Motherboard
CPU _n _Status	CPU _n status	CPU _n n indicates the CPU number with a value of 0 - 1

Sensor	Description	Sensor Location
CPU_Config	CPU configuration status: Mixed use of CPU, primary CPU not installed	CPU
CPU _n _MEM_Hot	CPU _n DIMM overtemperature	CPU _n n indicates the CPU number with a value of 0 - 1
CPU _n _CxDy	CPU _n DIMM status	The corresponding DIMM for CPU _n n indicates the CPU number with a value of 0 - 1 x indicates the memory channel number under the CPU with a value of 0 - 7 y indicates the DIMM number with a value of 0 - 1
FAN _n _Status	FAN _n failure status	FAN _n n indicates the fan number with a value of 0 - 7
FAN_Redundant	Fan redundancy lost alert status	Fans
PCIe_Status	PCIe card status error	PCIe card
Power_Button	Power button pressed	Motherboard and power button
Watchdog2	Watchdog	Motherboard
Sys_Health	BMC health status	BMC
UID_Button	UID button status	Motherboard
PWR_Drop	Voltage drop status	Motherboard
PWR_On_TMOUT	Power-on timeout	Motherboard
PWR_CAP_Fail	Power capping status	Motherboard
BP_F_Disk_Stat	Front drive backplane status	Drive backplane
PSU_Redundant	PSU redundancy lost alert status	PSU
PSU_Mismatch	Power supply model mismatch	PSU
PSU _n _Status	PSU _n failure status	PSU _n n indicates the PSU number with a value of 0 - 5

Sensor	Description	Sensor Location
Intrusion	Chassis-opening activity monitoring	Motherboard
SysShutdown	Reason for system shutdown	/
ACPI_PWR	ACPI status	/
ME_FW_Status	ME health status	/
SysRestart	Reason for system restart	/
BIOS_Boot_Up	BIOS boot up complete	/
System_Error	Emergency system failure	/
POST_Status	POST status	/
BMC_Boot_Up	Record the BMC boot event	/
SEL_Status	Record the event that system event logs are almost full/cleared	/
BMC_Status	BMC status	/

13 Appendix B Acronyms and Abbreviations

13.1 A - E

A

AC	Alternating Current
AI	Artificial Intelligence
ANSI	American National Standards Institute
ARS	Address Range Scrub

B

BIS	Bureau of Indian Standards
BIOS	Basic Input Output System
BMC	Baseboard Management Controller
BPS	Barlow Pass

C

CB	Certification Body
CCC	China Compulsory Certification
CE	Conformite Europeenne
CECP	China Energy Conservation Program
CEN	European Committee for Standardization
CLI	Command-Line Interface
CPLD	Complex Programmable Logic Device
CPU	Central Processing Unit
CRC	Cyclic Redundancy Check
CRPS	Common Redundant Power Supply

D

DC	Direct Current
DCMI	Data Center Manageability Interface
DDDC	Double Device Data Correction
DDR4	Double Date Rate 4
DFX	Design for X
DIMM	Dual In-Line Memory Module

E

EAC	Eurasian Conformity
ECC	Error-Correcting Code
ECMA	European Computer Manufacturers Association
EN	European Standard
ESD	Electrostatic Discharge
EVAC	Extended Volume Air Cooling
E1.S	Enterprise & Data Center SSD Form Factor 1 Unit Short

13.2 F - J

F

FCC	Federal Communications Commission
FHHL	Full Height Half Length
FRB	Fault Resilient Booting

G

GPU	Graphics Processing Unit
GUI	Graphical User Interface

H

HBA	Host Bus Adapter
HCA	Host Channel Adapter

HDD	Hard Disk Drive
HHHL	Half Height Half Length
HSE	Health and Safety Executive
HTML	Hyper Text Markup Language
HTTPS	Hypertext Transfer Protocol Secure

I

I/O	Input/Output
IMC	Integrated Memory Controller
IOPS	Input/Output Operations Per Second
IP	Internet Protocol
IPMI	Intelligent Platform Management Interface
IPv4	Internet Protocol version 4
IPv6	Internet Protocol version 6
ISO	International Organization for Standardization

13.3 K - O

K

KC	Korea Certification
KVM	Keyboard Video Mouse

L

LAN	Local Area Network
LED	Light Emitting Diode
LOM	LAN on Motherboard
LP	Low Profile
LRDIMM	Load Reduced Dual In-Line Memory Module

N

NCSI	Network Controller Sideband Interface
------	---------------------------------------

NIC	Network Interface Controller
NIOSH	National Institute for Occupational Safety and Health
NOM	Norma Oficial Mexicana
NVDIMM	Non-Volatile Dual In-Line Memory Module
NVMe	Non-Volatile Memory Express

O

OCP	Open Compute Project
OS	Operating System

13.4 P - T

P

PCH	Platform Controller Hub
PCI	Peripheral Component Interconnect
PCIe	Peripheral Component Interconnect express
PCLS	Partial Cache Line Sparing
PDU	Power Distribution Unit
PMem	Persistent Memory
PPR	Post Package Repair
PSU	Power Supply Unit
PXE	Pre-boot Execution Environment

R

RAS	Reliability, Availability, Serviceability
RAID	Redundant Arrays of Independent Disks
RCM	Regulatory Compliance Mark
RDIMM	Registered Dual In-line Memory Module
RH	Relative Humidity
RJ45	Registered Jack 45
RV	Rotatable Vibration
RST	Reset

RTC	Real Time Clock
-----	-----------------

S

SAS	Serial Attached SCSI
SATA	Serial Advanced Technology Attachment
SCSI	Small Computer System Interface
SDDC	Single Device Data Correction
SII	Standards Institution of Israel
SLES	SUSE Linux Enterprise Server
SNMP	Simple Network Management Protocol
SSD	Solid State Drive
SSH	Secure Shell

T

TCM	Trusted Cryptography Module
TDP	Thermal Design Power
TF	TransFLash
TPM	Trusted Platform Module

13.5 U - Z

U

UID	Unit Identification
UPI	Ultra Path Interconnect
USB	Universal Serial Bus

V

VGA	Video Graphics Array
VNC	Virtual Network Console
VPP	Virtual Pin Port
VRD	Voltage Regulator Down