



Inspur Server NF5280G7 Series

White Paper

Powered by Intel Processors

For NF5280-M7-A0-R0-00

Document Version: V0.9
Release Date: March 9, 2023

Applicable Model

Model	Maintenance	Cooling
NF5280-M7-A0-R0-00	Rear access	Air cooling

Copyright © 2023 Inspur Electronic Information Industry Co., Ltd. All rights reserved.

No part of this document may be reproduced or transmitted in any form or by any means without the prior written consent of Inspur.

Environmental Protection

Please dispose of product packaging by recycling at a local recycling center for a greener planet.

Trademarks

Inspur and the Inspur logo are registered trademarks of Inspur.

All other trademarks or registered trademarks mentioned herein may be the property of their respective holders. This document does not mark any product or brand with symbol (® or ™).

Security Statement

Inspur is intensely focused on server product safety and has placed a high priority on this. For a better understanding of our server products, carefully read through the following security risk statements.

- When servers are to be repurposed or retired, it is recommended to restore their firmware factory settings, delete information and clear logs from BIOS and BMC to protect data privacy. Meanwhile, we recommend you to wipe the drive data thoroughly and securely with trusted erasing tools. You can use Inspur Server Quick Provisioning. Contact us for specific server models to which ISQP is applicable.
- For server open source software statements, please contact Inspur Customer Service.
- Some interfaces and commands for production, assembly and return-to-depot, and advanced commands for locating faults, if used improperly, may cause equipment abnormality or business interruption. This is not described herein. Please contact Inspur for such information.

- External ports of Inspur servers do not use private protocols for communication.
- Our products will not initiatively obtain or use your personal data. Only when you consent to use certain functions or services, some personal data such as IP address and email address for alerts may be obtained or used during business operation or fault location. Inspur has implemented necessary measures on product functions to ensure personal data security throughout the data lifecycle, including but not limited to data collection, storage, use, transmission, and destruction. Meanwhile, you are obligated to establish necessary user privacy policies in accordance with applicable national/regional laws and regulations to fully protect user personal data.
- Committed to product data security, Inspur has implemented necessary measures on product functions to protect system operation and security data throughout its lifecycle in strict accordance with relevant laws, regulations and supervision requirements. As the owner of system operation and security data, you are obligated to establish necessary data security policies and take adequate measures in accordance with applicable national/regional laws and regulations to fully protect system operation and security data.
- Inspur will remain committed to the safety of our products and solutions to achieve better customer satisfaction. Inspur has established emergency response procedures and action plans for security vulnerabilities, so that product safety issues can be dealt with in a timely manner. Please contact Inspur Customer Service for any safety problems found or necessary support on security vulnerabilities when using our products.

Disclaimer

The purchased products, services and features shall be bound by the contract made between Inspur and the customer. All or part of the products, services and features described herein may not be within your purchase or usage scope. Unless otherwise agreed in the contract, Inspur makes no express or implied statement or warranty on the contents herein. Images provided herein are for reference only and may contain information or features that do not apply to your purchased model. This document is only used as a guide. Inspur shall not be liable for any damage, including but not limited to loss of profits, loss of information, interruption of business, personal injury, or any consequential damage incurred before, during, or after the use of our products. Inspur assumes you have sufficient knowledge of servers and are well trained in protecting yourself from personal injury or preventing product damages during operation and maintenance. The information in this document is subject to change without notice. Inspur shall not be liable for technical or editorial errors or omissions contained in this document.

Technical Support

Global Service Hotline: (+1)844-860-0011/(+1)325-880-0011
Address: No. 1036 Langchao Road, Jinan, China
Inspur Electronic Information Industry Co., Ltd.
Postal Code: 250101
Email: serversupport@inspur.com

Abstract

This white paper describes the NF5280G7 Intel-based server's appearance, features, performance parameters, and software and hardware compatibility, providing in-depth information of NF5280G7.





Intended Audience

This white paper is intended for:

- Inspur pre-sales engineers
- Pre-sales engineers of channel partners
- Enterprise pre-sales engineers

Symbol Conventions

The symbols that may be found in this document are defined as follows.

Symbol	Description
 DANGER	A potential for serious injury, or even death if not properly handled
 WARNING	A potential for minor or moderate injury if not properly handled
 CAUTION	A potential loss of data or damage to equipment if not properly handled
 IMPORTANT	Operations or information that requires special attention to ensure successful installation or configuration
 NOTE	Supplementary description of document information

Revision History

Version	Date	Description of Changes
V0.9	2023/03/09	Initial release

Table of Contents

1	Product Overview	9
2	Features	11
2.1	Scalability and Performance	11
2.2	Availability and Serviceability	12
2.3	Manageability and Security.....	13
2.4	Energy Efficiency	14
3	System Parts Breakdown	15
4	System Logical Diagram	17
5	Hardware Description.....	19
5.1	Front Panel.....	19
5.1.1	Front View.....	19
5.1.2	LEDs and Buttons	21
5.1.3	Ports	26
5.2	Rear Panel.....	29
5.2.1	Rear View.....	29
5.2.2	LEDs and Buttons	30
5.2.3	Ports	33
5.3	Processors.....	35
5.4	Memory.....	35
5.4.1	DDR5 DIMMs	35
5.5	Storage	40
5.5.1	Drive Configurations	40
5.5.2	Drive Numbering	42
5.5.3	Drive LEDs.....	53
5.5.4	RAID Controller Cards	54

5.6	Network	54
5.7	I/O Expansion	55
5.7.1	PCIe Cards.....	55
5.7.2	PCIe Slots	55
5.7.3	PCIe Slot Description.....	58
5.8	PSUs.....	60
5.9	Fans	61
5.10	LCD Module (Optional)	61
5.10.1	Function.....	61
5.10.2	Interface	63
5.11	Boards.....	64
5.11.1	Motherboard	64
5.11.2	Drive Backplanes	66
6	System Specifications	72
6.1	Technical Specifications	72
6.2	Environmental Specifications.....	75
6.3	Physical Specifications	77
7	Operating System and Hardware Compatibility	79
7.1	Supported Operating Systems	79
7.2	Hardware Compatibility	79
7.2.1	CPU Specifications	79
7.2.2	DIMM Specifications.....	80
7.2.3	Drive Specifications	80
7.2.4	SAS/RAID Controller Card Specifications	81
7.2.5	NIC Specifications	82
7.2.6	PSU Specifications	82
8	Regulatory Information	85

8.1	Safety.....	85
8.1.1	General.....	85
8.1.2	Personal Safety.....	85
8.1.3	Equipment Safety	87
8.1.4	Transportation Precautions	88
8.1.5	Manual Handling Weight Limits.....	88
9	Inspur Limited Warranty	89
9.1	Warranty Service	89
9.1.1	Remote Technical Support.....	89
9.1.2	RMA Service	90
9.1.3	ARMA Service	91
9.1.4	9 × 5 × NBD Onsite Service	91
9.1.5	24 × 7 × 4 Onsite Service	92
9.2	Inspur Service SLA	92
9.3	Warranty Exclusions	92
10	System Management.....	94
10.1	Intelligent Management System ISBMC	94
10.2	Inspur Physical Infrastructure Manager (ISPIM).....	97
10.3	Inspur Server Intelligent Boot (ISIB).....	99
11	Certifications	101
12	Appendix A.....	102
12.1	Operating Temperature Specification Limits	102
12.2	Model.....	105
12.3	RAS Features	105
12.4	Sensor List.....	105
13	Appendix B Acronyms and Abbreviations	109
13.1	A - E.....	109

13.2 F - J.....	111
13.3 K - O.....	112
13.4 P - T.....	114
13.5 U - Z.....	115

1 Product Overview

The Inspur NF5280G7 Intel-based system is a high-end 2-socket rack server that features the 4th Gen Intel Xeon Scalable processors. It is specially designed for high-end IT applications such as cloud computing, big data, data mining and deep learning. The product maintains the consistent high quality and superior reliability of Inspur servers, and brings innovation and breakthroughs in computing performance, scalability, configuration elasticity, and intelligent management. Hence it is well suited for a wide range of applications and can be widely used in various sectors.

Figure 1-1 12 × 3.5-inch Drive Configuration

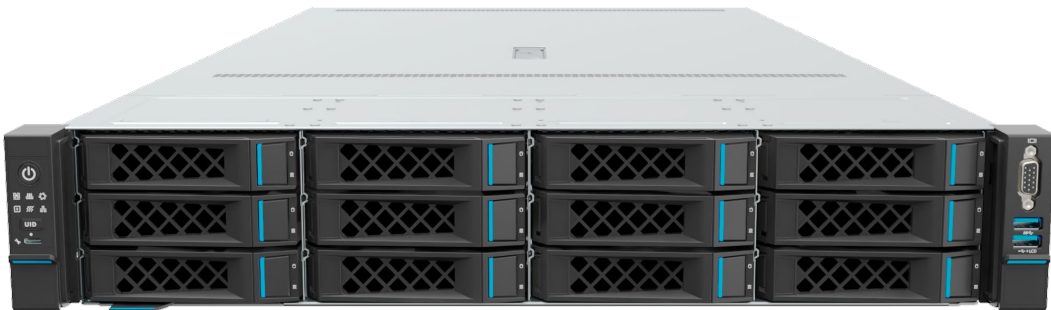

Figure 1-2 24 × 2.5-inch Drive Configuration

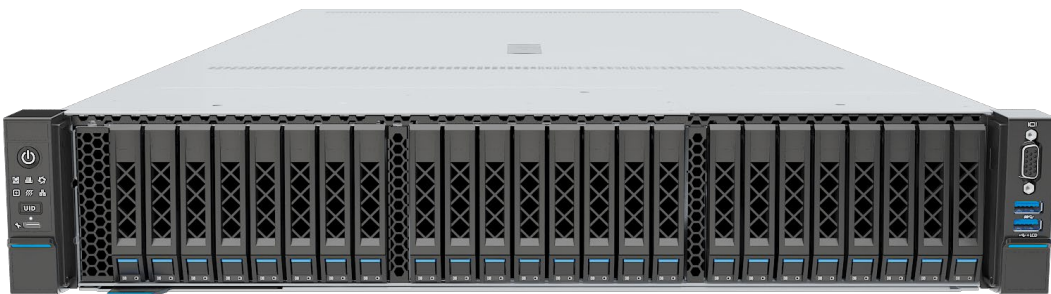

Figure 1-3 25 × 2.5-inch Drive Configuration

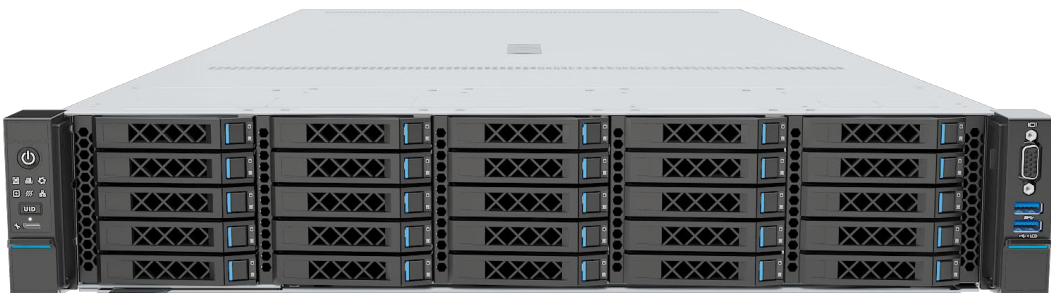

Figure 1-4 24 × E3.S Drive Configuration

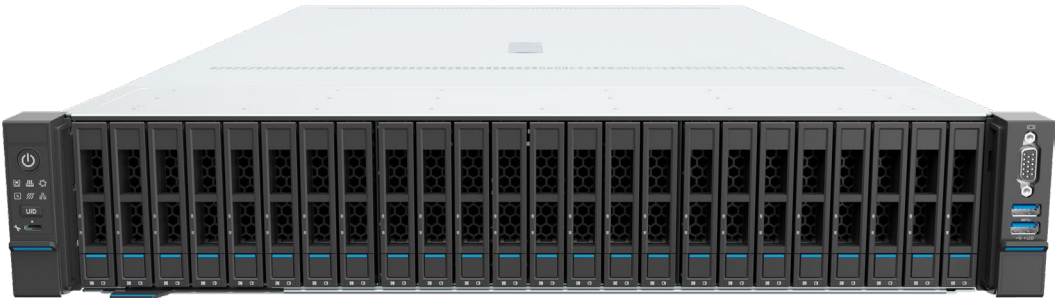

Figure 1-5 8 × 3.5-inch Drive Configuration



2 Features

2.1 Scalability and Performance

- Features the 4th Gen Intel Xeon Scalable processors (Sapphire Rapids/Emerald Rapids), with up to 64 cores per CPU, a maximum TDP of 350 W, a max Turbo frequency of 4.5 GHz, an L3 cache of 2 MB per core, and up to 4 UPI links per CPU at up to 20 GT/s, delivering unrivaled processing performance.
 - With the processor cache hierarchy optimization, a larger L2 cache of private 1 MB per core is provided, so that memory data can be put and processed directly in L2 cache, improving the memory access performance and reducing the demand on L3 cache capacity.
 - Supports Intel Turbo Boost Technology 2.0 and automatically scales CPU speeds up to the max Turbo frequency at peak workloads, allowing processor cores to exceed the thermal design power (TDP) for a limited time.
 - Supports Intel Hyper-Threading Technology, allowing up to 2 threads to run on each core to improve the performance of multi-threaded applications.
 - Supports Intel Virtualization Technology that provides hardware assist to the virtualization software, allowing the operating system to better use hardware to handle virtualized workloads.
 - Supports Intel Advanced Vector Extensions 512 (Intel AVX-512), significantly accelerating the workloads that are strongly floating point compute intensive.
 - Supports Intel DL Boost (VNNI) instructions, improving the performance for deep learning applications.
- Supports up to 32 DIMMs and multiple DIMM types.
 - Up to 32 DDR5 ECC DIMMs (4,800 MT/s, RDIMMs), delivering superior speed, high availability, and a memory capacity up to 4 TB.
 - Up to 16 Intel Optane Persistent Memory 300 Series (PMem for short), which must be used with DDR5 DIMMs. A single PMem supports a capacity of up to 512 GB and a bandwidth of 4,800 MHz, ensuring memory data persistence in case of power failure without compromising memory capacity and bandwidth.
- Flexible drive configurations, providing elastic and scalable storage solutions

to meet different capacity and upgrade requirements.

- Delivers all-SSD configuration, bringing higher I/O performance over all-HDD configuration or HDD-SSD mixing configuration.
- Offers 24 Gbps serial attached SCSI (SAS), quadrupling the data transfer rate of internal storage of 6 Gbps SAS solution and maximizing the performance of storage I/O-intensive applications.
- With Intel integrated I/O technology, the processors integrate the PCIe 5.0 controller to reduce I/O latency and enhance overall system performance.
- Up to 13 HHHL PCIe cards, further improving the I/O performance.
- Up to 4 dual-slot GPUs.

2.2 Availability and Serviceability

- Supports hot-swap SAS/SATA/NVMe drives and RAID controller cards with RAID levels 0/1/1E/10/5/50/6/60 (with SAS/SATA drives), RAID cache and data protection enabled by the super-capacitor in case of power failures. Supported RAID levels vary with RAID controller cards.
- Based on humanization design, the server allows tool-less maintenance. The modular structural parts enable quick removal/installation, greatly reducing O&M time.
- Inspur's unique intelligent control technology combined with the cutting-edge air-cooling technology creates an optimum operating environment to ensure stable running of the server.
- SSDs are much more reliable than traditional HDDs, increasing system uptime.
- The UID and status LEDs for fault diagnosis on the front panel, the plug-in LCD module, and the ISBMC Web GUI indicate the status of key components and quickly lead technicians to failed (or failing) components, simplifying maintenance, speeding up troubleshooting, and enhancing system availability.
- The ISBMC management port on the rear panel enables local ISBMC O&M, improving O&M efficiency.
- Provides 2 hot-swap PSUs with 1+1 redundancy and 6 hot-swap fan modules with N+1 redundancy, improving overall system availability.
- The onboard ISBMC monitors system parameters in real time and sends alerts in advance, enabling technicians to take appropriate measures to ensure system stable operation and minimize system downtime.

For documentation of the NF5280G7 system, such as product marketing materials, user manuals, product drivers, firmware, and product certifications, visit Inspur

website: <https://en.inspur.com>.

2.3 Manageability and Security

- The onboard ISBMC monitors system operating status and enables remote management.
 - ISBMC, a self-developed intelligent management system, is included with the server.
 - ISBMC supports such mainstream management specifications in the industry as IPMI 2.0 and Redfish 1.13.
 - ISBMC improves operational reliability.
 - ISBMC delivers easy serviceability for different business scenarios.
 - ISBMC provides comprehensive and accurate fault diagnosis capabilities.
 - ISBMC offers industry-leading security reinforcement capabilities.
- The Network Controller Sideband Interface (NC-SI) feature allows a network port to serve as a management port and a service port. The NC-SI feature is disabled by default and can be enabled/disabled through the BIOS or ISBMC.
- The industry-standard UEFI improves the efficiency of setup, configuration and update, and simplifying the error handling process.
- The Intel Platform Firmware Resilience (PFR) technology is supported.
- Trusted Platform Module (TPM) 2.0 and Trusted Cryptography Module (TCM) provide advanced encryption.
- Intel Trusted Execution Technology provides enhanced security through hardware-based resistance to malicious software attacks.
- The firmware update mechanism based on digital signatures prevents unauthorized firmware updates.
- UEFI Secure Boot protects the system from malicious bootloaders.
- Hierarchical password protection in BIOS ensures system boot and management security.
- BIOS Secure Flash and BIOS Lock Enable (BLE) reduce attacks from malicious software on the BIOS flash region.
- Dual-image mechanism for BMC and BIOS recovers firmware upon detection of firmware damage.
- BMC Secure Boot protects BMC from malicious tampering.
- Flexible BMC access control policies improve BMC management security.

- Chassis intrusion detection enhances physical security.
 - The optional front bezel with a lock prevents unauthorized users from removing or installing drives, and thus ensuring the security of local data.
-



The NC-SI port supports the following features:

- The NC-SI port can be bonded to any network port of the OCP card or of PCIe NIC that supports NC-SI.
 - Supports the enable/disable and configuration of Virtual Local Area Network (VLAN). VLAN is disabled by default and the default VLAN ID is 0.
 - Supports IPv6 and IPv4 addresses. IP address, subnet mask, default gateway, and prefix length of IPv6 address can be configured.
-

2.4 Energy Efficiency

- Equipped with 80 Plus Platinum/Titanium power supplies of different power efficiency levels, with power efficiency up to 96% at a load of 50%.
- Supports 1+1 power supply redundancy and AC/DC power input, improving power conversion efficiency.
- Features the high-efficiency single-board voltage regulator down (VRD) solution, reducing DC-DC conversion loss.
- Supports Proportional-Integral-Derivative (PID) intelligent fan speed control and intelligent CPU frequency scaling, conserving energy.
- Offers a fully-optimized system cooling design with energy-efficient cooling fans, lowering energy consumption from system cooling.
- Offers power capping and power control measures.
- Supports staggered spin-up of drives, reducing power consumption during server startup.
- Supports Intel Intelligent Power Capability (IIPC) to optimize energy usage in the processor cores by turning computing functions on only when needed.
- Supports low-voltage 4th Gen Intel Xeon Scalable processors (Sapphire Rapids/Emerald Rapids), consuming less energy and meeting the demands of data centers and telecommunications environments constrained by power and thermal.

3 System Parts Breakdown

Figure 3-1 Exploded View

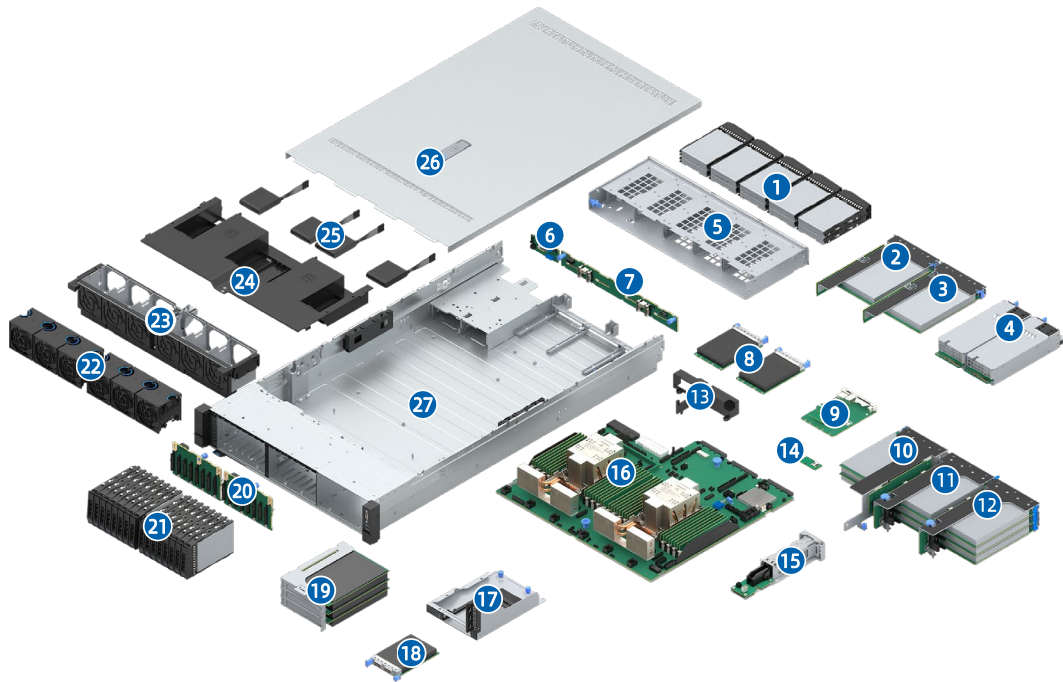

Item	Feature	Item	Feature
1	Rear 2.5-inch Drive × 10	15	Rear M.2 Module
2	Right PCIe Riser-Card Assembly	16	Motherboard
3	Left PCIe Riser-Card Assembly	17	Front PCIe Cage
4	PSU × 2	18	OCP 3.0 Card
5	Rear Drive Cage	19	Right PCIe Riser-Card Assembly (Front)
6	Rear Drive Backplane (for two 2.5-inch drives)	20	Front Drive Backplane (for eight 2.5-inch drives) × 2
7	Rear Drive Backplane (for eight 2.5-inch drives)	21	Front Drive × 16
8	OCP 3.0 Card × 2	22	Fan × 6
9	DC-SCM Board	23	Fan Cage
10	Right PCIe Riser-Card Assembly	24	System Air Duct
11	Middle PCIe Riser-Card Assembly	25	Super-Capacitor × 4
12	Left PCIe Riser-Card Assembly	26	Top Cover
13	PSU Air Duct	27	Chassis

Item	Feature	Item	Feature
14	TF Card Adapter Board		

4 System Logical Diagram

Figure 4-1 System Logical Diagram

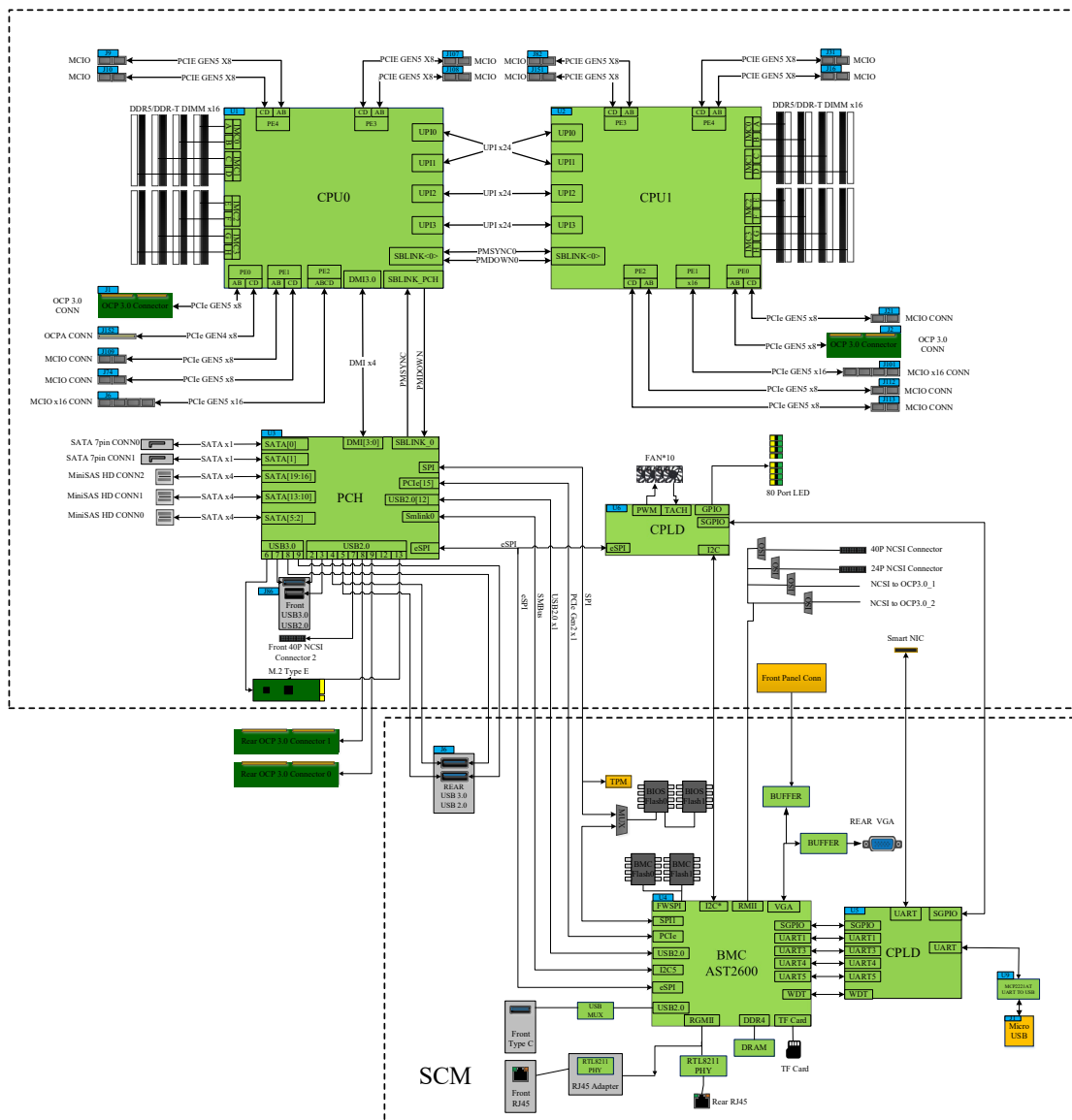

- Up to two 4th Gen Intel Xeon Scalable processors (Sapphire Rapids/Emerald Rapids).
- Up to 32 DIMMs.
- Up to 4 UPI links per CPU at up to 20 GT/s.
- Up to 13 PCIe slots and 2 OCP 3.0 slots. CPU0 and CPU1 each support 1 OCP 3.0 card.

- The mezz RAID card is connected to CPU0 via the PCIe bus, and is connected to the drive backplane via the SAS signal cable. Multiple local storage configurations are supported through different drive backplanes. The motherboard integrates the EBG PCH (Platform Controller Hub) to support 3 USB 3.0 ports, 14 SATA 3.0 connectors, and 1 TF card adapter board.
- The DC-SCM board integrates an AST 2600 management chip which supports a VGA port, a BMC management network port, a serial port, a TF card slot, and other connectors.

5 Hardware Description

5.1 Front Panel

5.1.1 Front View

- 12 × 3.5-inch Drive Configuration

Figure 5-1 Front View

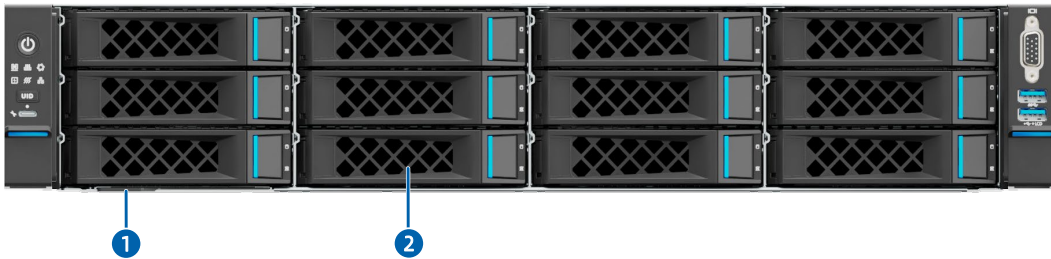

Item	Feature	Item	Feature
1	Serial Label Pull Tag (with an SN label)	2	Drive Bay × 12

- 24 × 2.5-inch Drive Configuration

Figure 5-2 Front View



Item	Feature	Item	Feature
1	Serial Label Pull Tag (with an SN label)	2	Drive Bay × 24

- 24 × E3.5 Drive Configuration

Figure 5-3 Front View

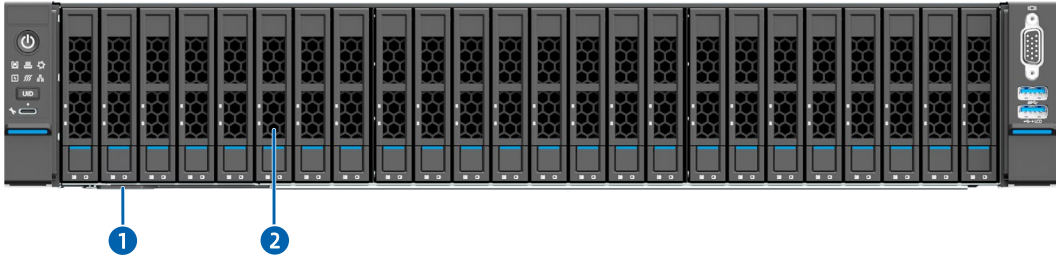

Item	Feature	Item	Feature
1	Serial Label Pull Tag (with an SN label)	2	Drive Bay × 24

- 25 × 2.5-inch Drive Configuration

Figure 5-4 Front View



Item	Feature	Item	Feature
1	Serial Label Pull Tag (with an SN label)	2	Drive Bay × 25

- 8 × 3.5-inch Drive Configuration

Figure 5-5 Front View

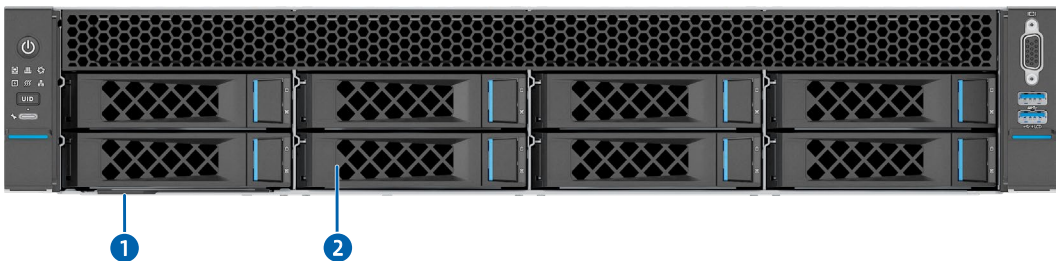

Item	Feature	Item	Feature
1	Serial Label Pull Tag (with an SN label)	2	Drive Bay × 8

5.1.2 LEDs and Buttons

- 12 × 3.5-inch Drive Configuration

Figure 5-6 Front Panel LEDs and Buttons

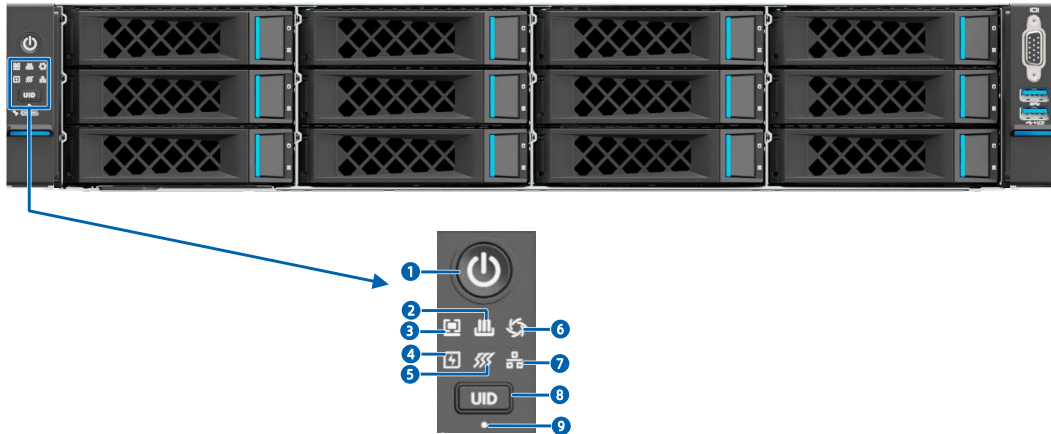

Item	Feature	Item	Feature
1	Power Button and LED	2	Memory Status LED
3	System Status LED	4	Power Status LED
5	System Overheat LED	6	Fan Status LED
7	Network Status LED	8	UID/BMC RST Button and LED
9	USB Type-C Status LED		

- 24 × 2.5-inch Drive Configuration

Figure 5-7 Front Panel LEDs and Buttons

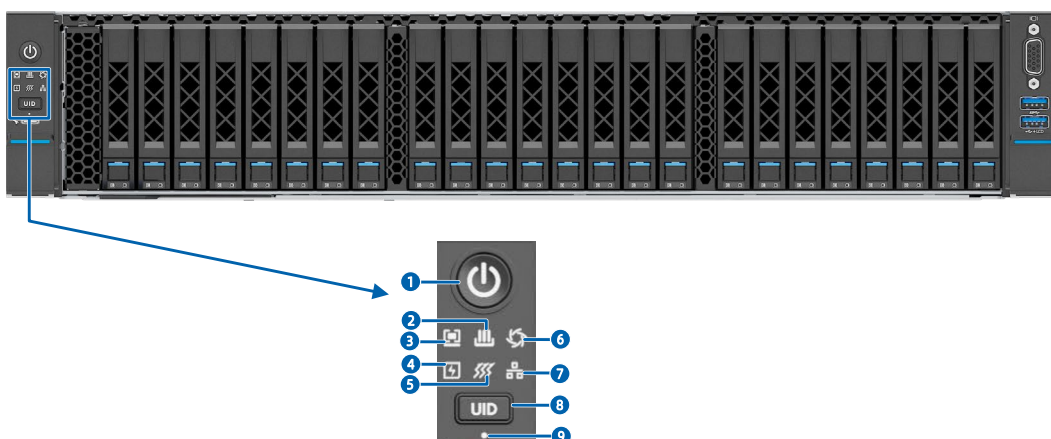

Item	Feature	Item	Feature
1	Power Button and LED	2	Memory Status LED
3	System Status LED	4	Power Status LED
5	System Overheat LED	6	Fan Status LED
7	Network Status LED	8	UID/BMC RST Button and LED
9	USB Type-C Status LED		

- 25 × 2.5-inch Drive Configuration

Figure 5-8 Front Panel LEDs and Buttons

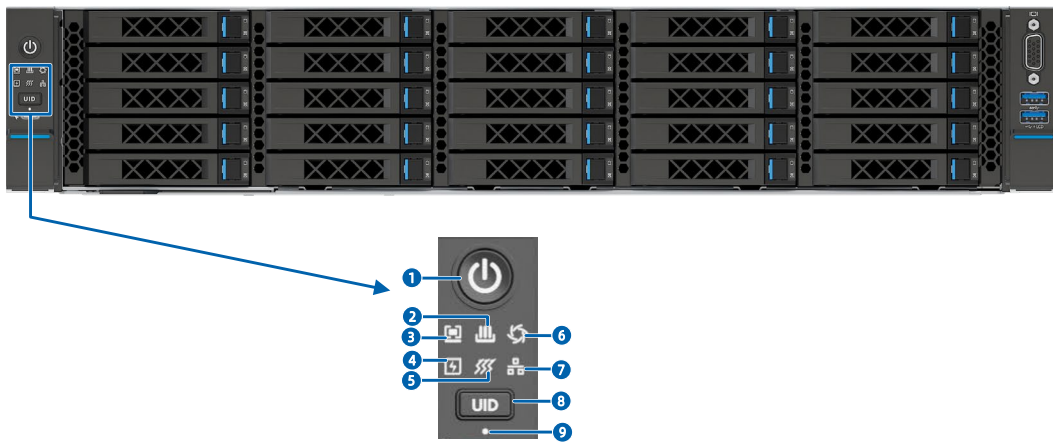

Item	Feature	Item	Feature
1	Power Button and LED	2	Memory Status LED
3	System Status LED	4	Power Status LED
5	System Overheat LED	6	Fan Status LED
7	Network Status LED	8	UID/BMC RST Button and LED
9	USB Type-C Status LED		

- 24 × E3.5 Drive Configuration

Figure 5-9 Front Panel LEDs and Buttons

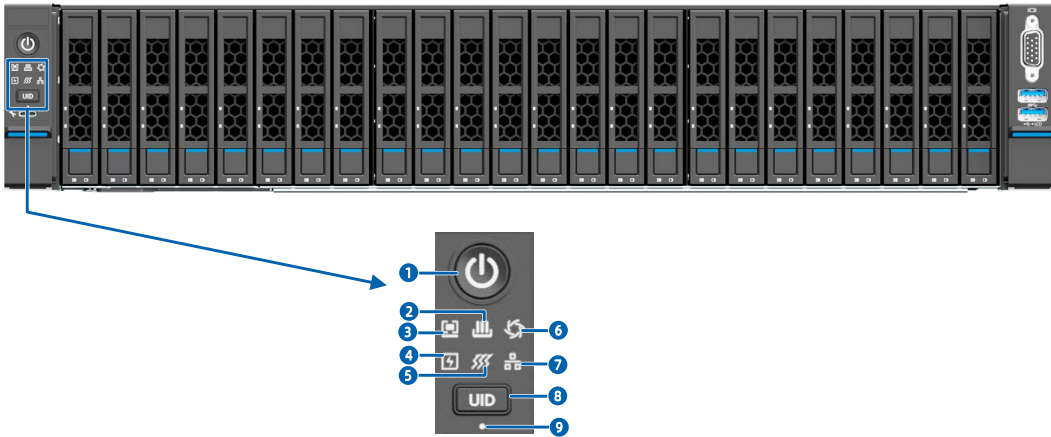

Item	Feature	Item	Feature
1	Power Button and LED	2	Memory Status LED
3	System Status LED	4	Power Status LED
5	System Overheat LED	6	Fan Status LED
7	Network Status LED	8	UID/BMC RST Button and LED
9	USB Type-C Status LED		

- 8 × 3.5-inch Drive Configuration

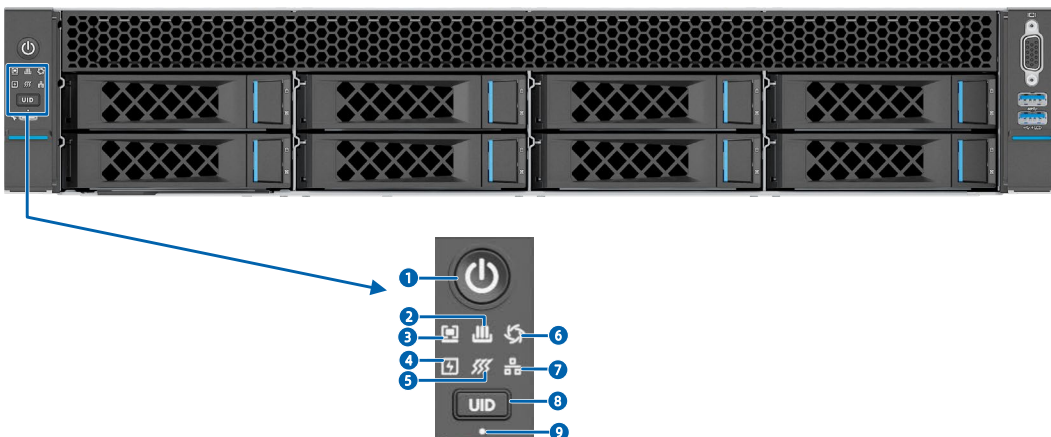

Figure 5-10 Front Panel LEDs and Buttons









Item	Feature	Item	Feature
1	Power Button and LED	2	Memory Status LED
3	System Status LED	4	Power Status LED
5	System Overheat LED	6	Fan Status LED
7	Network Status LED	8	UID/BMC RST Button and LED
9	USB Type-C Status LED		

1. LED and Button Description

Table 5-1 Front Panel LED and Button Description

Icon	LED and Button	Description
	Power Button and LED	<p>Power LED:</p> <ul style="list-style-type: none"> Off = No power Solid green = Power-on state Solid orange = Standby state <p>Power button:</p> <p>Long press the button for over 6 seconds to force a shutdown from the power-on state.</p> <p>Notes:</p> <ul style="list-style-type: none"> Follow the prompt under the OS to shut it down. Short press the power button to power on the system in standby state.
UID	UID/BMC RST Button and LED	<p>The UID LED is used to identify the device to be operated.</p> <ul style="list-style-type: none"> Off = System unit not identified Solid blue = System unit identified Flashing blue = System being operated remotely <p>Notes:</p> <ul style="list-style-type: none"> The UID LED turns on when activated by the UID button or via ISBMC remotely. Long press the UID button for over 6 seconds to reset the BMC.
	Memory Status LED	<ul style="list-style-type: none"> Off = Normal Flashing red (1 Hz) = A warning occurs Solid red = A failure occurs

Icon	LED and Button	Description
	System Status LED	<ul style="list-style-type: none"> • Off = Normal • Flashing red (1 Hz) = A warning occurs • Solid red = A failure occurs
	Power Status LED	<ul style="list-style-type: none"> • Off = Normal • Flashing red (1 Hz) = A warning occurs • Solid red = A failure occurs
	System Overheat LED	<ul style="list-style-type: none"> • Off = Normal • Flashing red (1 Hz) = A warning occurs • Solid red = A failure occurs
	Fan Status LED	<ul style="list-style-type: none"> • Off = Normal • Flashing red (1 Hz) = A warning occurs • Solid red = A failure occurs
	Network Status LED	<ul style="list-style-type: none"> • Off = Self-developed OCP card not installed or no network connection • Flashing green = Network connected with data being transmitted • Solid green = Network connected without data being transmitted <p>Note: It only indicates the status of the self-developed OCP card.</p>
	USB Type-C Status LED	<p>Connects to a terminal (PC or phone):</p> <ul style="list-style-type: none"> • Off = Port not connected to a terminal (PC or phone). • Fast flashing for 3 seconds and then off = Port function has been disabled. • Solid green = Port connected to a terminal (PC or phone). <p>Connects to a USB storage device:</p> <ul style="list-style-type: none"> • Off = Port not connected to a USB storage device.

Icon	LED and Button	Description
		<ul style="list-style-type: none"> • Slow flashing red = Job has failed or job has been completed with an error reported • Fast flashing green = Job in progress. • Fast flashing green for 5 seconds and then off = Port function has been disabled. • Solid green = Job has been completed.

5.1.3 Ports

- 12 × 3.5-inch Drive Configuration

Figure 5-11 Front Panel Ports

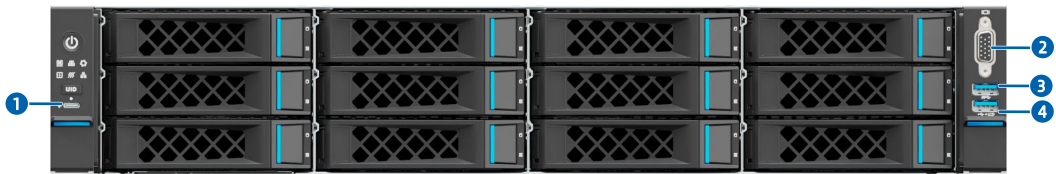

Item	Feature	Item	Feature
1	USB Type-C Port	2	VGA Port
3	USB 3.0 Port	4	USB 2.0/LCD Port

- 24 × 2.5-inch Drive Configuration

Figure 5-12 Front Panel Ports



Item	Feature	Item	Feature
1	USB Type-C Port	2	VGA Port
3	USB 3.0 Port	4	USB 2.0/LCD Port

- 25 × 2.5-inch Drive Configuration

Figure 5-13 Front Panel Ports



Item	Feature	Item	Feature
1	USB Type-C Port	2	VGA Port
3	USB 3.0 Port	4	USB 2.0/LCD Port

- 24 × E3.S Drive Configuration

Figure 5-14 Front Panel Ports



Item	Feature	Item	Feature
1	USB Type-C Port	2	VGA Port
3	USB 3.0 Port	4	USB 2.0/LCD Port

- 8 × 3.5-inch Drive Configuration

Figure 5-15 Front Panel Ports



Item	Feature	Item	Feature
1	USB Type-C Port	2	VGA Port
3	USB 3.0 Port	4	USB 2.0/LCD Port

1. Port Description

Table 5-2 Front Panel Port Description

Feature	Type	Quantity	Description
VGA Port	DB15	1	Enables you to connect a display terminal, for example, a monitor or KVM, to the system.
USB 3.0 Port	USB 3.0	1	Enables you to connect a USB 3.0 device to the system. Important: Make sure that the USB device is in good condition or it may cause the server to work abnormally.
USB 2.0/LCD Port	USB 2.0	1	<ul style="list-style-type: none"> Enables you to connect a USB 2.0 device to the system. Important: Make sure that the USB device is in good condition or it may cause the server to work abnormally. <ul style="list-style-type: none"> Enables you to connect an Inspur exclusive LCD module to the system.
USB Type-C Port	Type-C	1	<ul style="list-style-type: none"> Enables you to connect to a terminal (local PCs with Windows 10 or later OS, or Android/iOS mobile phones) for BMC local maintenance, to monitor and manage the system Notes: <ul style="list-style-type: none"> On your local PC, enter the BMC IP address (for example, https://1.2.3.4) in the browser address bar to log in to the BMC. On your phone, use the mobile application Inspur Server Mobile Manage (ISMM) to access the BMC. <ul style="list-style-type: none"> Enables you to connect a USB storage device to the system for automatic log copying to the USB device and automatic of importing to the BMC. Notes: <ul style="list-style-type: none"> BMC provides USB management interface, for searching and configuring functions of the BMC management network port. BMC provides the function to enable/disable the USB management (enabled by default), displaying the USB device access status of being connected or disconnected.

Feature	Type	Quantity	Description
			<ul style="list-style-type: none"> BMC records operations on the USB device in the audit log after the device is connected to the system.

5.2 Rear Panel

5.2.1 Rear View

Figure 5-16 Rear Views

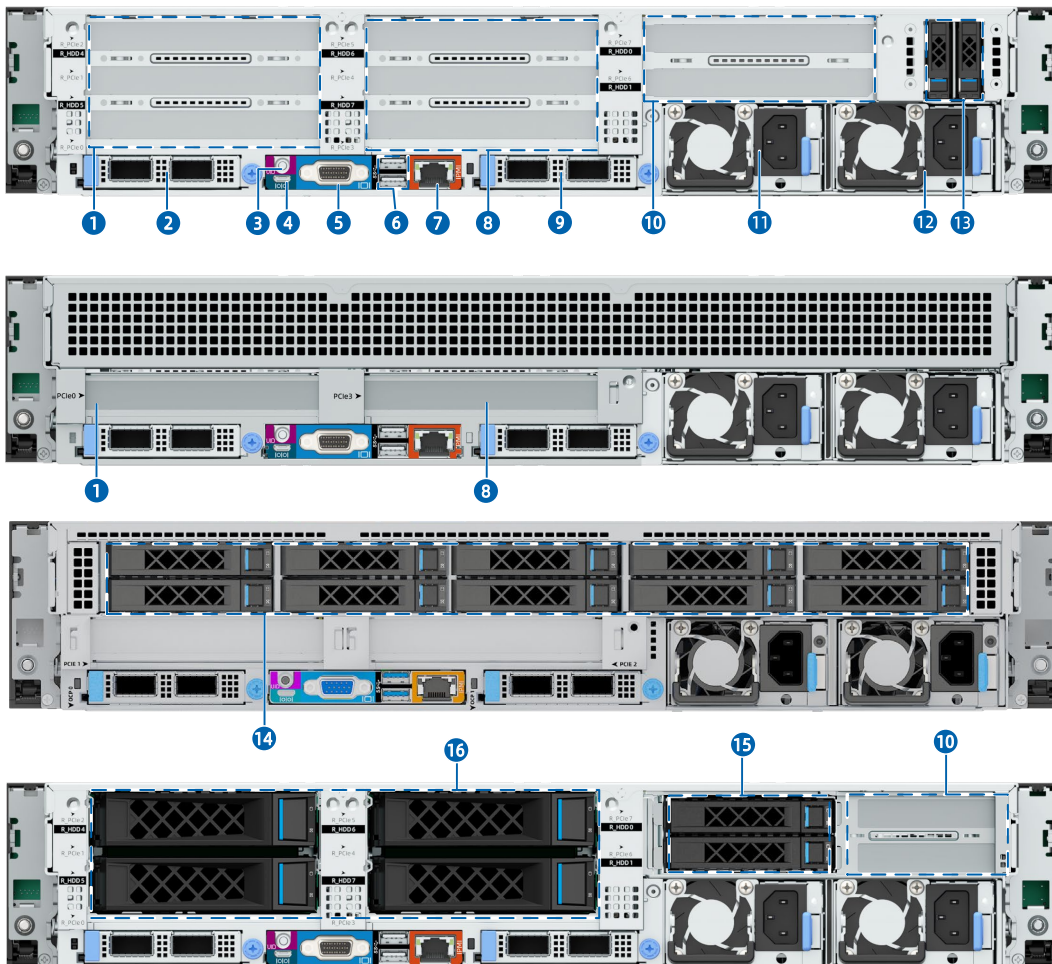

Item	Feature	Item	Feature
1	Left PCIe Rise Module (PCIe Slot × 3)	9	OCP 3.0 Card 1
2	OCP 3.0 Card 0	10	Right PCIe Riser Module (PCIe Slot × 2)
3	UID/BMC RST Button and LED	11	PSU0
4	System/BMC Serial Port	12	PSU1

Item	Feature	Item	Feature
5	VGA Port	13	Rear M.2/E1.S Drive Bay × 2
6	USB 3.0 Port × 2	14	Rear 2.5-inch Drive Bay × 10
7	BMC Management Network Port	15	Rear 2.5-inch Drive Bay × 2
8	Middle PCIe Riser Module (PCIe Slot × 3)	16	Rear 3.5-inch Drive Bay × 4

5.2.2 LEDs and Buttons

Figure 5-17 Rear Panel LEDs and Buttons

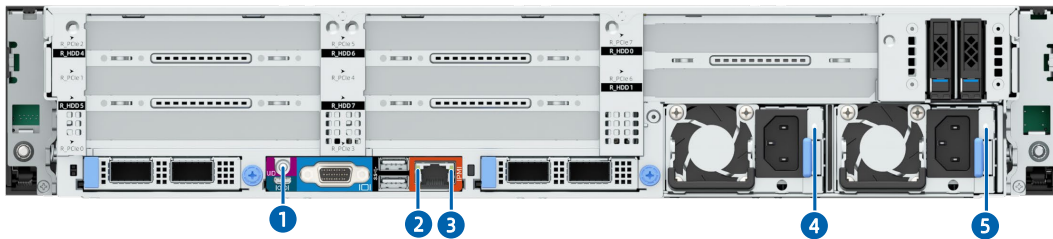

Item	Feature	Item	Feature
1	UID/BMC RST Button and LED	2	Management Network Port Link Speed LED
3	Management Network Port Link Activity LED	4	PSU LED0
5	PSU LED1		

Figure 5-18 Rear Panel LEDs and Buttons

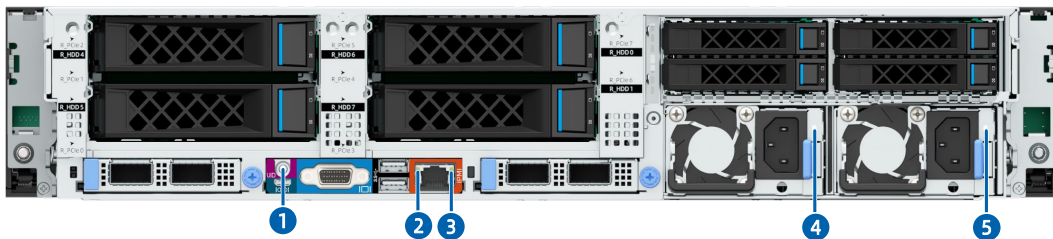

Item	Feature	Item	Feature
1	UID/BMC RST Button and LED	2	Management Network Port Link Speed LED
3	Management Network Port Link Activity LED	4	PSU LED0
5	PSU LED1		

Figure 5-19 Rear Panel LEDs and Buttons

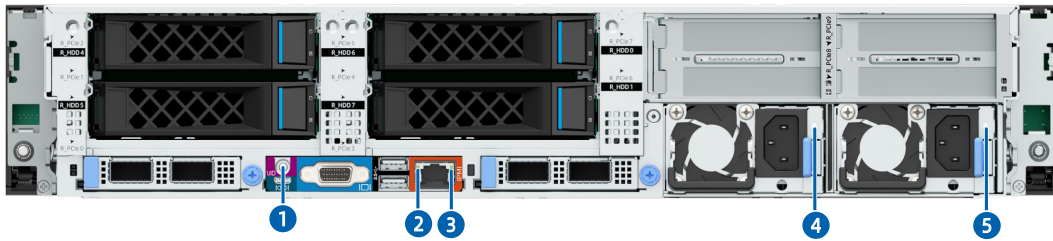

Item	Feature	Item	Feature
1	UID/BMC RST Button and LED	2	Management Network Port Link Speed LED
3	Management Network Port Link Activity LED	4	PSU LED0
5	PSU LED1		

Figure 5-20 Rear Panel Buttons and LEDs

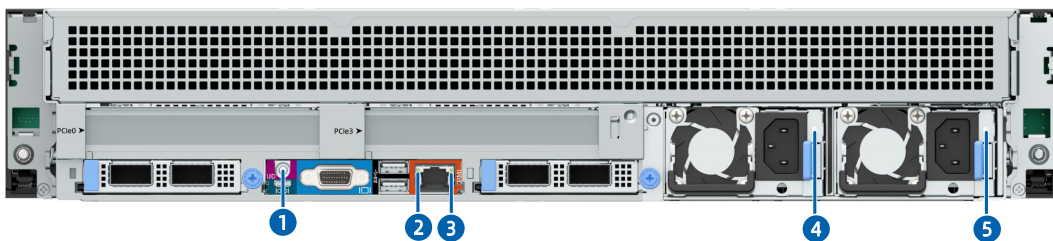

Item	Feature	Item	Feature
1	UID/BMC RST Button and LED	2	Management Network Port Link Speed LED
3	Management Network Port Link Activity LED	4	PSU LED0
5	PSU LED1		

1. LED and Button Description

Table 5-3 Rear Panel LED and Button Description

LED and Button	Description
UID/BMC RST Button and LED	The UID LED is used to identify the device to be operated. <ul style="list-style-type: none"> Off = System unit not identified Solid blue = System unit identified

LED and Button	Description
	<ul style="list-style-type: none"> • Flashing blue = System unit being operated remotely <p>Notes:</p> <ul style="list-style-type: none"> • The UID LED turns on when activated by the UID button or via ISBMC remotely. • Long press the UID button for 6 seconds to reset the BMC.
Management Network Port Link Speed LED	<ul style="list-style-type: none"> • Off = No network connection • Solid green = Network connected with link speed at 1,000 Mbps • Solid orange = Network connected with link speed at 10/100 Mbps
Management Network Port Link Activity LED	<ul style="list-style-type: none"> • Off = No network connection • Solid green = Network connected without data being transmitted • Flashing green = Network connected with data being transmitted
PSU LED	<ul style="list-style-type: none"> • Off = No power to PSU • Flashing green (1 Hz) = PSU operating in standby state with normal input • Flashing green (2 Hz) = PSU firmware updating • Flashing green (off for 1 second and on for 2 seconds) = PSU in cold redundant state • Solid green = Normal input and output • Flashing amber (1 Hz) = PSU warning event where the PSU continues to operate (possible causes: PSU overtemperature, PSU output overcurrent, excessively high or low fan speed) • Solid amber = Normal input, but no output (possible causes: PSU overtemperature protection, PSU output overcurrent or short circuit, output overvoltage, short circuit protection, component (not all components) failure)

5.2.3 Ports

1. Port Location

Figure 5-21 Rear Panel Ports

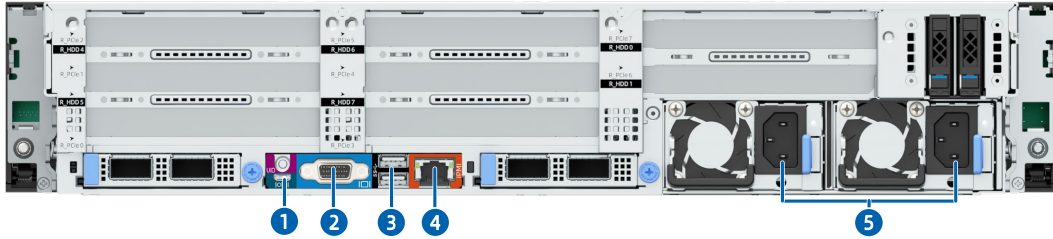

Item	Feature	Item	Feature
1	System/BMC Serial Port	2	VGA Port
3	USB 3.0 Port × 2	4	BMC Management Network Port
5	PSU Socket × 2		

Figure 5-22 Rear Panel Ports

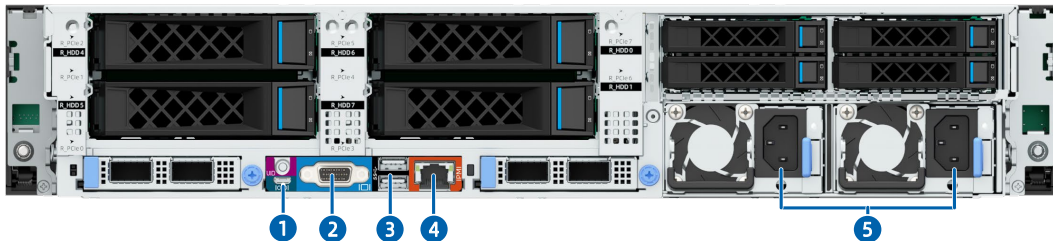

Item	Feature	Item	Feature
1	System/BMC Serial Port	2	VGA Port
3	USB 3.0 Port × 2	4	BMC Management Network Port
5	PSU Socket × 2		

Figure 5-23 Rear Panel Ports

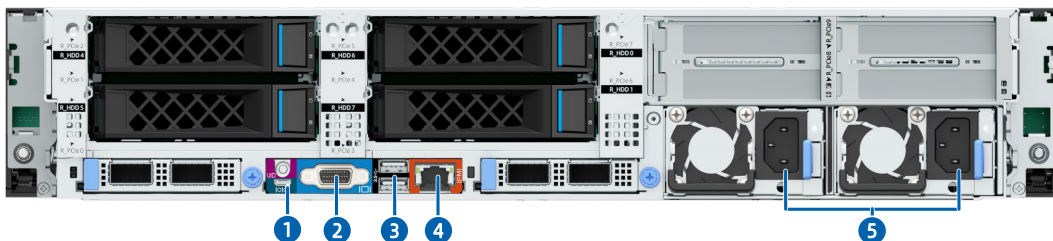

Item	Feature	Item	Feature
1	System/BMC Serial Port	2	VGA Port

Item	Feature	Item	Feature
3	USB 3.0 Port × 2	4	BMC Management Network Port
5	PSU Socket × 2		

Figure 5-24 Rear Panel Ports

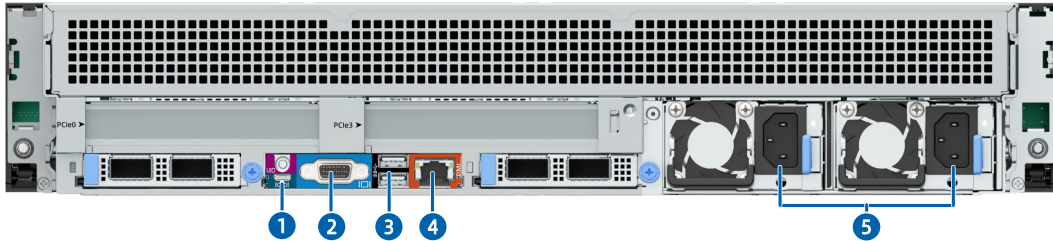

Item	Feature	Item	Feature
1	System/BMC Serial Port	2	VGA Port
3	USB 3.0 Port × 2	4	BMC Management Network Port
5	PSU Socket × 2		

2. Port Description

Table 5-4 Rear Panel Port Description

Feature	Type	Quantity	Description
System/BMC Serial Port	Micro USB	1	<ul style="list-style-type: none"> Enables you to capture system and BMC logs and debug the BMC. Enables you to print system logs <p>Note: It is a micro USB serial port with a default baud rate of 115,200 bit/s.</p>
USB 3.0 Port	USB 3.0	2	<p>Enables you to connect a USB 3.0 device to the system.</p> <p>Important:</p> <ul style="list-style-type: none"> When using an external USB device, the current supported by the USB port is no more than 0.9 A. Make sure that the USB device is in good condition or it may cause the server to work abnormally.
BMC Management Network Port	RJ45	1	<p>ISBMC management network port, used to manage the server.</p> <p>Note:</p>

Feature	Type	Quantity	Description
			It is a Gigabit Ethernet port that supports 100 Mbps and 1,000 Mbps auto-negotiation.
VGA Port	DB15	1	Enables you to connect a display terminal, for example, a monitor or KVM, to the system.
PSU Socket	N/A	2	Connected through a power cord. Users can select the PSUs as needed. Note: Make sure that the total rated power of every PSU is greater than that of the server.

5.3 Processors

- Supports up to two 4th Gen Intel Xeon Scalable processors.
- If only 1 processor is configured, install it in the CPU0 socket.
- The processors used in a server must be of the same model.

For specific system processor options, consult your local Inspur sales representative or refer to [7.2 Hardware Compatibility](#).

5.4 Memory

5.4.1 DDR5 DIMMs

1. Identification

To determine DIMM characteristics, refer to the label attached to the DIMM and the following figure and table.

Figure 5-25 DIMM Identification

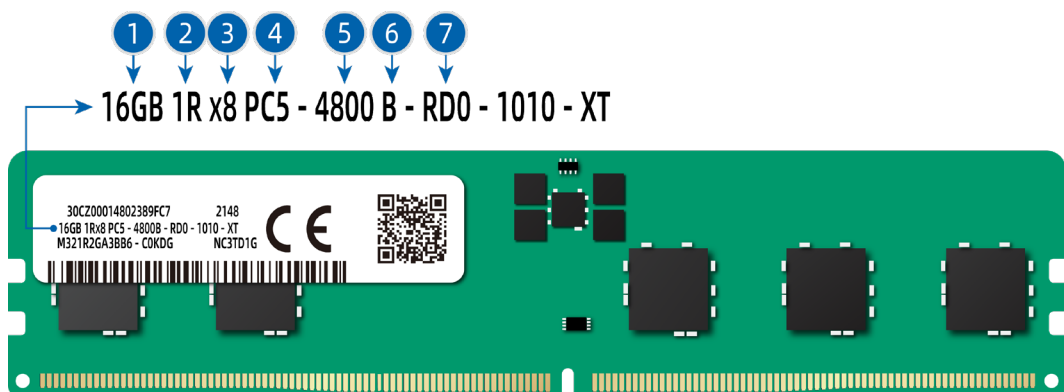

Item	Description	Example
1	Capacity	<ul style="list-style-type: none"> • 16 GB • 32 GB • 64 GB • 128 GB • 256 GB
2	Rank(s)	<ul style="list-style-type: none"> • 1R = Single rank • 2R = Dual rank • 2S2R = Two ranks of two high stacked 3DS DRAM • 4DR = Four ranks of dual die packaged DRAM • 4R = Quad rank
3	Data width of DRAM	<ul style="list-style-type: none"> • x4 = 4 bits • x8 = 8 bits
4	DIMM slot type	PC5 = DDR5
5	Maximum memory speed	4,800 MT/s
6	CAS latency	B = 4800 40-39-39
7	DIMM type	R = RDIMM

2. Memory Subsystem Architecture

The server supports 32 DIMM slots and 8 channels per CPU.

Within a channel, populate the DIMM slot with its silk screen ending with D0 first and second the DIMM slot with its silk screen ending with D1. For instance, within CPU0 Channel 0, populate CPU0_C0D0 first and second CPU0_C0D1.

Table 5-5 DIMM Slot List

CPU	Channel ID	Silk Screen
CPU0	Channel 0	CPU0_C0D0
		CPU0_C0D1
	Channel 1	CPU0_C1D0

CPU	Channel ID	Silk Screen
	Channel 1	CPU0_C1D1
		CPU0_C2D0
	Channel 2	CPU0_C2D1
		CPU0_C3D0
	Channel 3	CPU0_C3D1
		CPU0_C4D0
	Channel 4	CPU0_C4D1
		CPU0_C5D0
	Channel 5	CPU0_C5D1
		CPU0_C6D0
	Channel 6	CPU0_C6D1
		CPU0_C7D0
	Channel 7	CPU0_C7D1
		Channel 0
Channel 1	CPU1_C0D1	
	Channel 2	CPU1_C1D0
Channel 3		CPU1_C1D1
	Channel 4	CPU1_C2D0
Channel 5		CPU1_C2D1
	Channel 6	CPU1_C3D0
Channel 7		CPU1_C3D1
	Channel 0	CPU1_C4D0
Channel 1		CPU1_C4D1
	Channel 2	CPU1_C5D0
Channel 3		CPU1_C5D1
	Channel 4	CPU1_C6D0
Channel 5		CPU1_C6D1
	Channel 6	CPU1_C7D0
Channel 7		CPU1_C7D1

3. Compatibility

Refer to the following rules to select the DDR5 DIMMs.

i IMPORTANT

- A server must use DDR5 DIMMs with the same part number (P/N code). All DDR5 DIMMs operate at the same speed, which is the lowest of:
 - Memory speed supported by a specific CPU.
 - Maximum operating speed of a specific memory configuration.
- Mixing DDR5 DIMM specifications (capacity, bit width, rank, height, etc.) is

not supported.

- For specific system memory options, consult your local Inspur sales representative or refer to [7.2 Hardware Compatibility](#).
-

- DDR5 DIMMs can be used with the 4th Gen Intel Xeon Scalable processors (Sapphire Rapids/Emerald Rapids). The maximum memory capacity supported is identical for different CPU models.
 - The total memory capacity is the sum of the capacities of all DDR5 DIMMs.
-



Maximum number of DIMMs supported per channel ≤ Maximum number of ranks supported per channel/Number of ranks per DIMM

Table 5-6 DDR5 DIMM Specifications

Item		Value			
Capacity per DDR5 DIMM (GB)		16	32	64	128
Type		RDIMM	RDIMM	RDIMM	RDIMM
Rated speed (MT/s)		4,800	4,800	4,800	4,800
Operating voltage (V)		1.1	1.1	1.1	1.1
Maximum number of DDR5 DIMMs supported in a server ^a		32	32	32	32
Maximum capacity of DDR5 DIMMs supported in a server (GB) ^b		512	1,024	2,048	4,096
Actual speed (MT/s)	1DPC ^c	4,800	4,800	4,800	4,800
	2DPC	4,400	4,400	4,400	4,400
a: The maximum number of DDR5 DIMMs supported is based on the 2-processor configuration. The number is halved for the 1-processor configuration. b: It indicates the maximum memory capacity supported when all the DIMM slots are populated with DDR5 DIMMs. c: DIMM Per Channel (DPC) is the number of DIMMs per memory channel. The above information is for reference only, consult your local Inspur sales representative for details.					

4. Population Rules

General population rules for DDR5 DIMMs:

- Install DIMMs only when the corresponding processor is installed.

- Install dummies in the empty DIMM slots.

Population rules for DDR5 DIMMs in specific modes:

- Memory sparing
 - Follow the general population rules.
 - Each channel must have a valid online spare configuration.
 - Each channel can have a different online spare configuration.
 - Each channel with a DIMM installed must have a spare rank.
- Memory mirroring
 - Follow the general population rules.
 - Each processor supports 4 integrated memory controllers (IMCs). Each IMC has 2 channels to be populated with DIMMs. Installed DIMMs must be identical in size and organization.
 - In a multi-processor configuration, each processor must have a valid memory mirroring configuration.

5. DIMM Slot Layout

Up to 32 DDR5 DIMMs can be installed in a server, and a balanced DIMM configuration is recommended for optimal memory performance. DIMM configuration must be compliant with the DIMM population rules.

Figure 5-26 DIMM Slot Layout

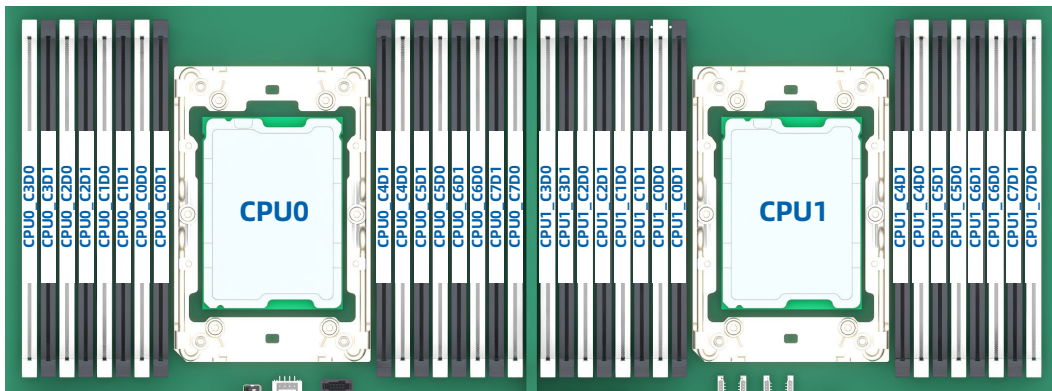

Table 5-7 DDR5 DIMM Population Rules (1-Processor Configuration)

DDR5 Qty	CPU0															
	iMC0				iMC1				iMC2				iMC3			
	C0		C1		C2		C3		C4		C5		C6		C7	
	D0	D1	D0	D1	D0	D1	D0	D1	D0	D1	D0	D1	D0	D1	D0	D1
1	v															
2	v													v		
4	v					v				v				v		
6	v					v		v		v		v		v		
8	v		v			v		v		v		v		v		v
12	v	v	v			v	v	v		v	v	v		v	v	v
16	v	v	v	v		v	v	v	v	v	v	v		v	v	v

Table 5-8 DDR5 DIMM Population Rules (2-Processor Configuration)

DDR5 Qty	CPU0																CPU1															
	iMC0				iMC1				iMC2				iMC3				iMC0				iMC1				iMC2				iMC3			
	C0		C1		C2		C3		C4		C5		C6		C7		C0		C1		C2		C3		C4		C5		C6		C7	
	D0	D1	D0	D1	D0	D1	D0	D1	D0	D1	D0	D1	D0	D1	D0	D1	D0	D1	D0	D1	D0	D1	D0	D1	D0	D1	D0	D1	D0	D1	D0	D1
2	v																v															
4	v																v															
8	v					v											v															
12	v					v		v									v		v													
16	v		v			v		v									v		v													
24	v	v	v			v	v	v									v	v	v													
32	v	v	v	v		v	v	v	v								v	v	v	v												

5.5 Storage

5.5.1 Drive Configurations

Table 5-9 Drive Configurations

Configuration	Front Drives	Internal Drives	Drive Management Mode
8 × 2.5-inch SAS/SATA Drive Configuration	Only SAS/SATA drives in drive bays 0-7	M.2 SSD on the M.2 adapter or onboard	SAS/SATA drives: 1 × RAID controller card
16 × 2.5-inch SAS/SATA Drive Configuration	Only SAS/SATA drives in drive bays 0-15	M.2 SSD on the M.2 adapter or onboard	SAS/SATA drives: 2 × RAID controller card
24 × 2.5-inch SAS/SATA Drive Configuration	Only SAS/SATA drives in drive bays 0-23	M.2 SSD on the M.2 adapter or onboard	SAS/SATA drives: 3 × RAID controller card
25 × 2.5-inch SAS/SATA Drive Configuration	Only SAS/SATA drives in drive bays 0-24	M.2 SSD on the M.2 adapter or onboard	SAS/SATA drives: 1 × RAID controller card
8 × 2.5-inch NVMe Configuration	Only NVMe drives in drive bays 0-7	M.2 SSD on the M.2 adapter or onboard	NVMe drives: directly

Configuration	Front Drives	Internal Drives	Drive Management Mode
			connected to CPUs
16 × 2.5-inch NVMe Configuration	Only NVMe drives in drive bays 0-15	M.2 SSD on the M.2 adapter or onboard	NVMe drives: directly connected to CPUs
24 × 2.5-inch NVMe Configuration	Only NVMe drives in drive bays 0-23	M.2 SSD on the M.2 adapter or onboard	NVMe drives: directly connected to CPUs
8 × 2.5-inch SAS/SATA Drive + 16 × 2.5-inch NVMe Configuration	Only SAS/SATA drives in drive bays 0-7 and only NVMe drives in drive bays 8-23	M.2 SSD on the M.2 adapter or onboard	<ul style="list-style-type: none"> SAS/SATA drives: 1 × RAID controller card NVMe drives: directly connected to CPUs
16 × 2.5-inch SAS/SATA Drive + 8 × 2.5-inch NVMe Configuration	Only SAS/SATA drives in drive bays 0-15 and only NVMe drives in drive bays 16-23	M.2 SSD on the M.2 adapter or onboard D	<ul style="list-style-type: none"> SAS/SATA drives: 2 × RAID controller card NVMe drives: directly connected to CPUs
21 × 2.5-inch SAS/SATA Drive + 4 × 2.5-inch NVMe Configuration	Only SAS/SATA drives in drive bays 0-20 and only NVMe drives in drive bays 21-24	M.2 SSD on the M.2 adapter or onboard	<ul style="list-style-type: none"> SAS/SATA drives: 1 × RAID controller card NVMe drives:

Configuration	Front Drives	Internal Drives	Drive Management Mode
			directly connected to CPUs
12 × 2.5-inch/3.5-inch SAS/SATA Drive Configuration	Only SAS/SATA drives in drive bays 0-11	M.2 SSD on the M.2 adapter or onboard	SAS/SATA drives: 1 × RAID controller card
12 × 2.5-inch NVMe Configuration	Only NVMe drives in drive bays 0-11	M.2 SSD on the M.2 adapter or onboard	NVMe drives: directly connected to CPUs

5.5.2 Drive Numbering



In this section, it is assumed that the 8i RAID controller card is used.

- 8 × 2.5-inch SAS/SATA Drive Configuration

Figure 5-27 Drive Numbering



Physical Drive No.	Drive No. Identified by the ISBMC	Drive No. Identified by the RAID Controller Card
0	0	0
1	1	1
2	2	2
3	3	3
4	4	4
5	5	5
6	6	6

Physical Drive No.	Drive No. Identified by the ISBMC	Drive No. Identified by the RAID Controller Card
7	7	7

- 16 × 2.5-inch SAS/SATA Drive Configuration

Figure 5-28 Drive Numbering



Physical Drive No.	Drive No. Identified by the ISBMC	Drive No. Identified by the RAID Controller Card
0	0	0
1	1	1
2	2	2
3	3	3
4	4	4
5	5	5
6	6	6
7	7	7
8	8	0
9	9	1
10	10	2
11	11	3
12	12	4
13	13	5
14	14	6
15	15	7

- 24 × 2.5-inch SAS/SATA Drive Configuration

Figure 5-29 Drive Numbering

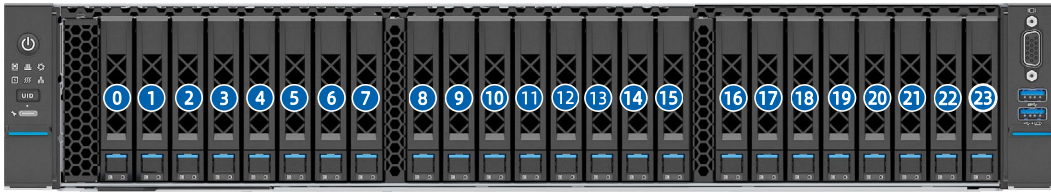

Physical Drive No.	Drive No. Identified by the ISBMC	Drive No. Identified by the RAID Controller Card
0	0	0
1	1	1
2	2	2
3	3	3
4	4	4
5	5	5
6	6	6
7	7	7
8	8	0
9	9	1
10	10	2
11	11	3
12	12	4
13	13	5
14	14	6
15	15	7
16	16	0
17	17	1
18	18	2
19	19	3
20	20	4
21	21	5
22	22	6
23	23	7

- 8 × 2.5-inch NVMe Configuration

Figure 5-30 Drive Numbering



Physical Drive No.	Drive No. Identified by the ISBMC	Drive No. Identified by the RAID Controller Card
0	0	-
1	1	-
2	2	-
3	3	-
4	4	-
5	5	-
6	6	-
7	7	-

- 16 × 2.5-inch NVMe Configuration

Figure 5-31 Drive Numbering



Physical Drive No.	Drive No. Identified by the ISBMC	Drive No. Identified by the RAID Controller Card
0	0	-
1	1	-
2	2	-
3	3	-
4	4	-
5	5	-
6	6	-
7	7	-
8	8	-
9	9	-

Physical Drive No.	Drive No. Identified by the ISBMC	Drive No. Identified by the RAID Controller Card
10	10	-
11	11	-
12	12	-
13	13	-
14	14	-
15	15	-

- 8 × 2.5-inch SAS/SATA Drive + 16 × 2.5-inch NVMe Configuration

Figure 5-32 Drive Numbering



Physical Drive No.	Drive No. Identified by the ISBMC	Drive No. Identified by the RAID Controller Card
0	0	0
1	1	1
2	2	2
3	3	3
4	4	4
5	5	5
6	6	6
7	7	7
8	8	-
9	9	-
10	10	-
11	11	-
12	12	-
13	13	-
14	14	-
15	15	-
16	16	-

Physical Drive No.	Drive No. Identified by the ISBMC	Drive No. Identified by the RAID Controller Card
17	17	-
18	18	-
19	19	-
20	20	-
21	21	-
22	22	-
23	23	-

- 16 × 2.5-inch SAS/SATA Drive + 8 × 2.5-inch NVMe Configuration

Figure 5-33 Drive Numbering



Physical Drive No.	Drive No. Identified by the ISBMC	Drive No. Identified by the RAID Controller Card
0	0	0
1	1	1
2	2	2
3	3	3
4	4	4
5	5	5
6	6	6
7	7	7
8	8	0
9	9	1
10	10	2
11	11	3
12	12	4
13	13	5
14	14	6
15	15	7

Physical Drive No.	Drive No. Identified by the ISBMC	Drive No. Identified by the RAID Controller Card
16	16	-
17	17	-
18	18	-
19	19	-
20	20	-
21	21	-
22	22	-
23	23	-

- 25 × 2.5-inch SAS/SATA Drive Configuration

Figure 5-34 Drive Numbering

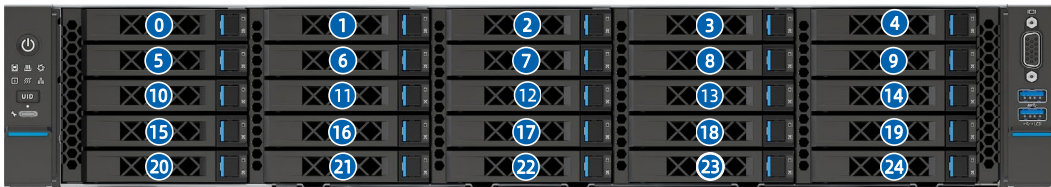

Physical Drive No.	Drive No. Identified by the ISBMC	Drive No. Identified by the RAID Controller Card
0	0	0
1	1	1
2	2	2
3	3	3
4	4	4
5	5	5
6	6	6
7	7	7
8	8	8
9	9	9
10	10	10
11	11	11
12	12	12
13	13	13
14	14	14

Physical Drive No.	Drive No. Identified by the ISBMC	Drive No. Identified by the RAID Controller Card
15	15	15
16	16	16
17	17	17
18	18	18
19	19	19
20	20	20
21	21	21
22	22	22
23	23	23
24	24	24

- 21 × 2.5-inch SAS/SATA Drive + 4 × NVMe Configuration

Figure 5-35 Drive Numbering

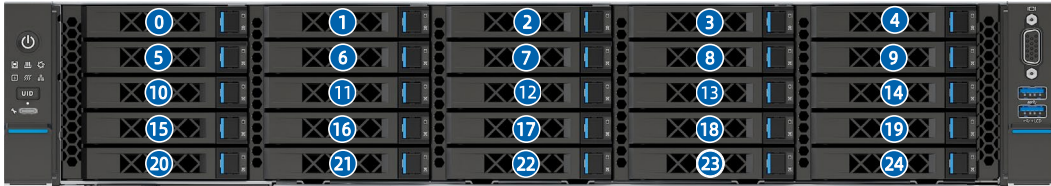

Physical Drive No.	Drive No. Identified by the ISBMC	Drive No. Identified by the RAID Controller Card
0	0	0
1	1	1
2	2	2
3	3	3
4	4	4
5	5	5
6	6	6
7	7	7
8	8	8
9	9	9
10	10	10
11	11	11
12	12	12

Physical Drive No.	Drive No. Identified by the ISBMC	Drive No. Identified by the RAID Controller Card
13	13	13
14	14	14
15	15	15
16	16	16
17	17	17
18	18	18
19	19	19
20	20	20
21	21	-
22	22	-
23	23	-
24	24	-

- 24 × E3.S Drive Configuration

Figure 5-36 Drive Numbering

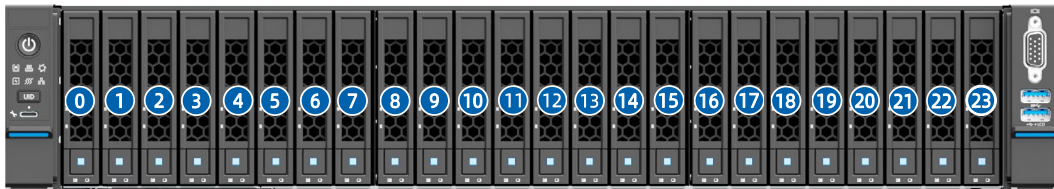

Physical Drive No.	Drive No. Identified by the ISBMC	Drive No. Identified by the RAID Controller Card
0	0	-
1	1	-
2	2	-
3	3	-
4	4	-
5	5	-
6	6	-
7	7	-
8	8	-
9	9	-
10	10	-

Physical Drive No.	Drive No. Identified by the ISBMC	Drive No. Identified by the RAID Controller Card
11	11	-
12	12	-
13	13	-
14	14	-
15	15	-
16	16	-
17	17	-
18	18	-
19	19	-
20	20	-
21	21	-
22	22	-
23	23	-

- 8 × 3.5-inch SAS/SATA Drive Configuration

Figure 5-37 Drive Numbering

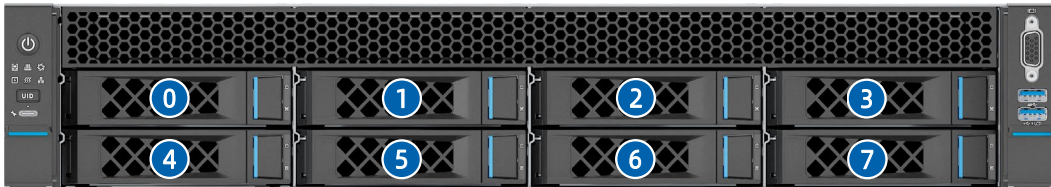

Physical Drive No.	Drive No. Identified by the ISBMC	Drive No. Identified by the RAID Controller Card
0	0	0
1	1	1
2	2	2
3	3	3
4	4	4
5	5	5
6	6	6
7	7	7

- 12 × 3.5/2.5-inch SAS/SATA Drive Configuration

Figure 5-38 Drive Numbering

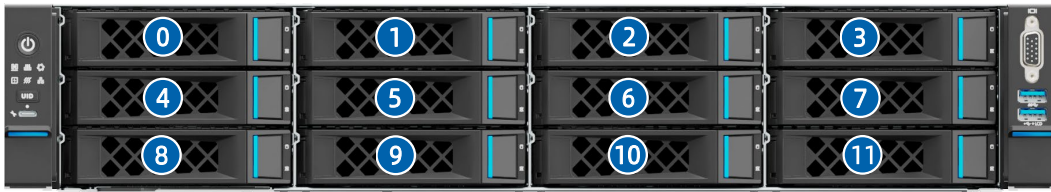

Physical Drive No.	Drive No. Identified by the ISBMC	Drive No. Identified by the RAID Controller Card
0	0	0
1	1	1
2	2	2
3	3	3
4	4	4
5	5	5
6	6	6
7	7	7
8	8	8
9	9	9
10	10	10
11	11	11

- 12 × 2.5-inch NVMe Configuration

Figure 5-39 Drive Numbering

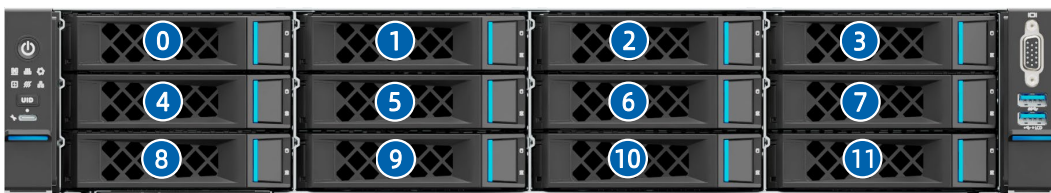

Physical Drive No.	Drive No. Identified by the ISBMC	Drive No. Identified by the RAID Controller Card
0	0	-
1	1	-
2	2	-
3	3	-
4	4	-
5	5	-

Physical Drive No.	Drive No. Identified by the ISBMC	Drive No. Identified by the RAID Controller Card
6	6	-
7	7	-
8	8	-
9	9	-
10	10	-
11	11	-

5.5.3 Drive LEDs

1. SAS/SATA Drive LEDs

Figure 5-40 SAS/SATA Drive LEDs



Table 5-10 SAS/SATA Drive LED Description

Activity LED (Green)	Error LED (Blue/Red)		Description
	Blue	Red	
Off	Off	RAID created	Drive absent
		Solid on	
Solid on	Off	Off	Drive present but not in use
Flashing	Off	Off	Drive present and in use
Flashing	Solid pink		Copyback/Rebuild in progress
Solid on	Solid on	Off	Drive selected but not in use
Flashing	Solid on	Off	Drive selected and in use
Off	Solid on	Off	Drive selected and failed
Any status	Off	Solid on	Drive failed

2. NVMe Drive LEDs

Figure 5-41 NVMe Drive LEDs



When the VMD function is enabled with the latest VMD driver installed, the NVMe drives support surprise hot swap.

Table 5-11 NVMe Drive LED Description

Activity LED (Green)	Error LED (Blue/Red)		Description
	Blue	Red	
Off	Off	Off	Drive absent
Solid on	Off	Off	Drive present but not in use
Flashing	Off	Off	Drive present and in use
Flashing	Solid pink		Copyback/Rebuilding/Initializing/ Verifying in progress
Solid on	Solid on	Off	Drive selected but not in use
Flashing	Solid on	Off	Drive selected and in use
Off	Solid on	Off	Drive selected and failed
Any status	Off	Solid on	Drive failed

5.5.4 RAID Controller Cards

The RAID controller card provides functions such as RAID configuration, RAID level migration, and drive roaming. For specific RAID controller card options, consult your local Inspur sales representative or refer to [7.2 Hardware Compatibility](#).

5.6 Network

NICs provide network expansion capabilities.

- The OCP I/O slot supports the OCP 3.0 card. Users can select the OCP 3.0 card as needed.
- The PCIe expansion slots support PCIe NICs. Users can select the PCIe cards as needed.
- For specific network options, consult your local Inspur sales representative or

refer to [7.2 Hardware Compatibility](#).

5.7 I/O Expansion

5.7.1 PCIe Cards

PCIe cards provide system expansion capabilities.

- The server supports up to 13 PCIe expansion slots.
- For specific PCIe card options, consult your local Inspur sales representative or refer to [7.2 Hardware Compatibility](#).

5.7.2 PCIe Slots

1. PCIe Slot Positions

Figure 5-42 PCIe Slots - 8 PCIe Slots + 2 M.2 Drive Bays Configuration

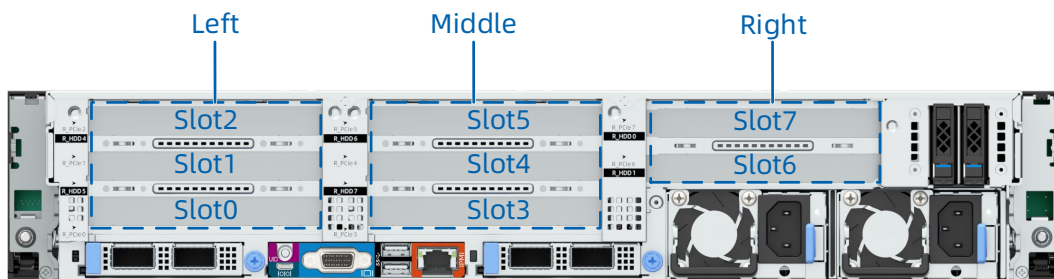

- Slot 2, slot 1, and slot 0 reside in the left PCIe riser module.
- Slot 5, slot 4, and slot 3 reside in the middle PCIe riser module.
- Slot 7 and slot 6 reside in the right PCIe riser module.

Figure 5-43 PCIe Slots - 10 PCIe Slots Configuration

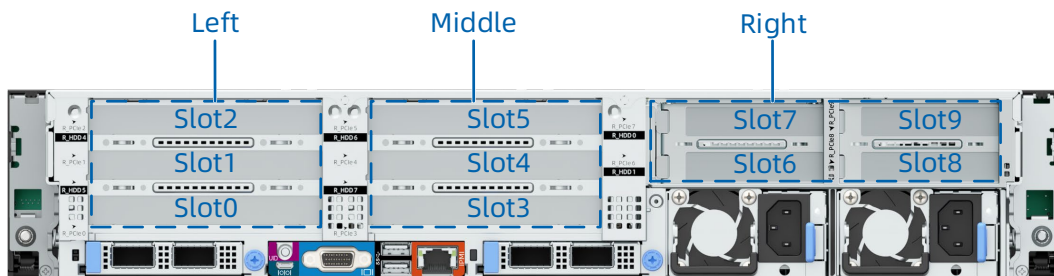

- Slot 2, slot 1, and slot 0 reside in the left PCIe riser module.
- Slot 5, slot 4, and slot 3 reside in the middle PCIe riser module.

- Slot 9, slot 8, slot 7, and slot 6 reside in the right PCIe riser module.

Figure 5-44 PCIe Slots - GPU Configuration

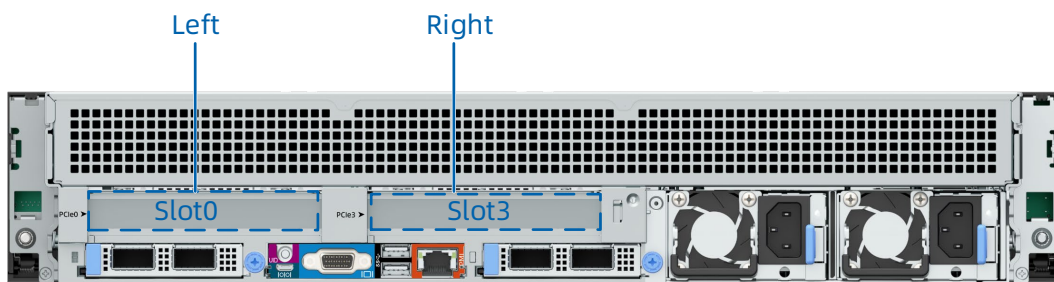

- The top 1U space supports up to 4 dual-slot GPUs.
- Slot 0/3 in the bottom 1U space supports an FHHL PCIe expansion card.

2. PCIe Riser Modules

- Left PCIe Riser Module 1 (with 3 slots)
 - Slot 2, slot 1, and slot 0 reside in this module.

Figure 5-45 PCIe Riser Module 1

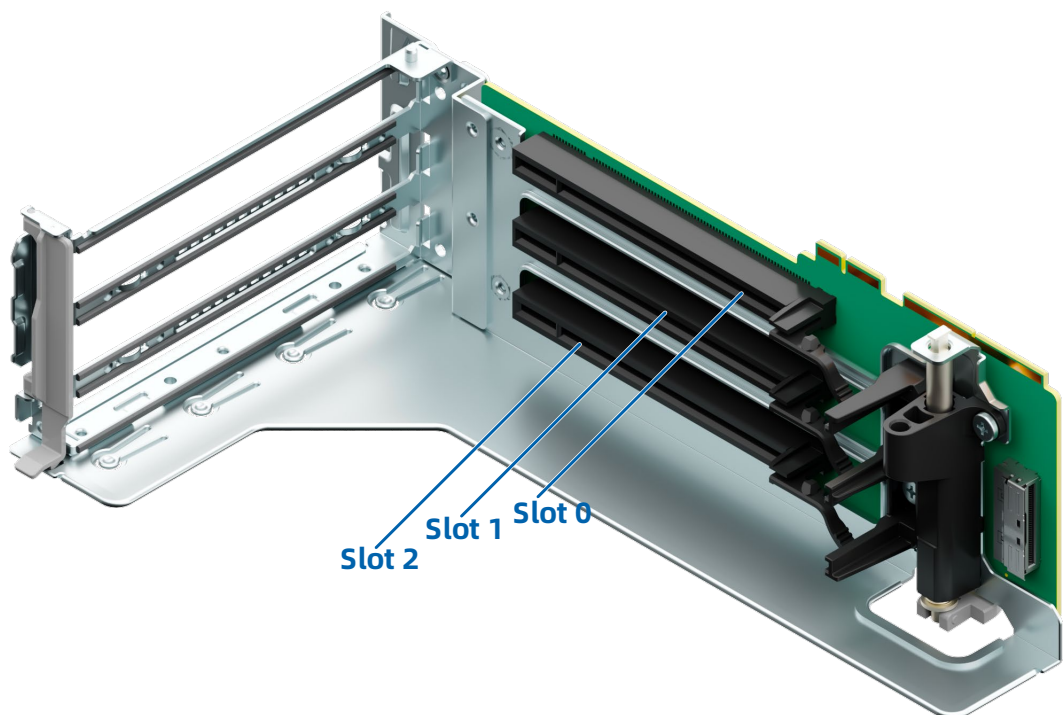

- Middle PCIe Riser Module 2 (with 3 slots)
 - Slot 5, Slot 4, and Slot 3 reside in this module.

Figure 5-46 PCIe Riser Module 2

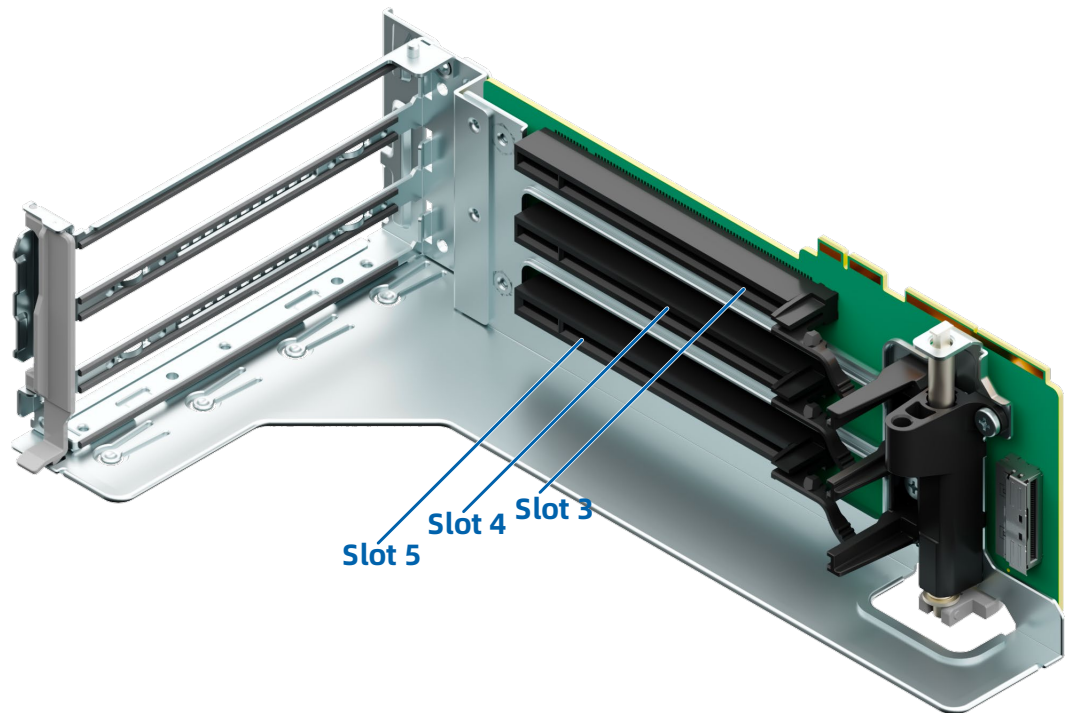

- Right PCIe Riser Module 3 (with 2 slots)
 - Slot 9/7 and slot 8/6 reside in this module.

Figure 5-47 PCIe Riser Module 3

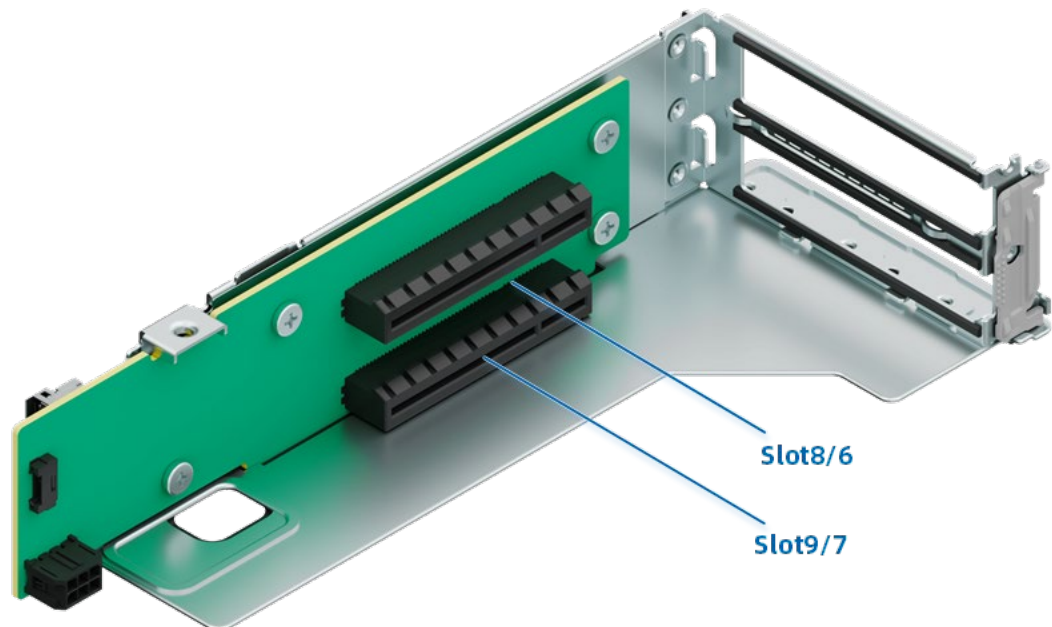

- Right PCIe Riser Module 4 (with 2 slots)

- Slot 7 and slot 6 reside in this module.

Figure 5-48 PCIe Riser Module 4

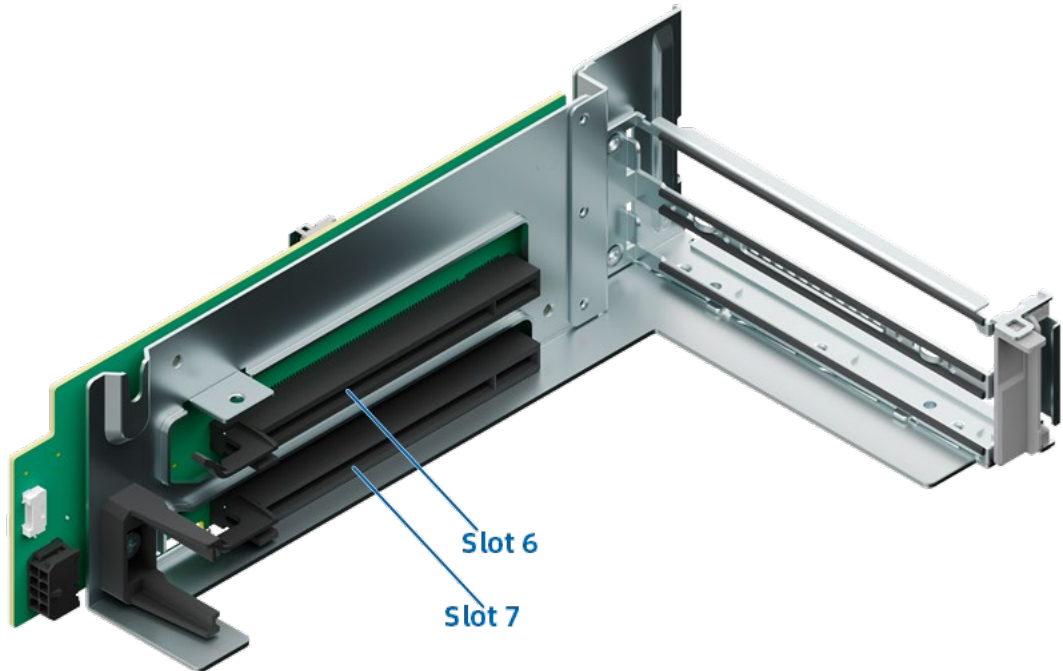

5.7.3 PCIe Slot Description



NOTE

When CPU1 is absent, the corresponding PCIe slots are not available.

1. Configurations with Rear PCIe Riser Modules

Table 5-12 PCIe Slot Description - Configuration of 8 Rear PCIe Slots (1)

PCIe Slot	Owner	PCIe Standard	Connector Width	Bus Width	Port No.	Form Factor
Slot 0	CPU0	PCIe 5.0	x16	x16	PE2	FHHL
Slot 1	CPU0	PCIe 5.0	x16	x16	PE1	FH 3/4L
Slot 2	CPU0	PCIe 5.0	x16	x16	PE3	FH 3/4L
Slot 3	CPU1	PCIe 5.0	x16	x16	PE1	FHHL
Slot 4	CPU1	PCIe 5.0	x16	x16	PE2	FH 3/4L
Slot 5	CPU0	PCIe 5.0	x16	x16	PE4	FH 3/4L
Slot 6	CPU1	PCIe 5.0	x16	x16	PE3	FH 3/4L
Slot 7	CPU1	PCIe 5.0	x16	x16	PE4	FH 3/4L

PCIe Slot	Owner	PCIe Standard	Connector Width	Bus Width	Port No.	Form Factor
OCP 3.0 Slot	CPU0	PCIe 5.0	x16	x16	PE0	Standard OCP 3.0 specs
OCP 3.0 Slot	CPU1	PCIe 5.0	x8/x16	x8/x16	PE0	Standard OCP 3.0 specs

Table 5-13 PCIe Slot Description - Configuration of 8 Rear PCIe Slots (2)

PCIe Slot	Owner	PCIe Standard	Connector Width	Bus Width	Port No.	Form Factor
Slot 0	CPU0	PCIe 5.0	x8	x8	PE2	FHHL
Slot 1	CPU0	PCIe 5.0	x8	x8	PE2	FH 3/4L
Slot 2	CPU0	PCIe 5.0	x16	x16	PE1	FH 3/4L
Slot 3	CPU1	PCIe 5.0	x8	x8	PE1	FHHL
Slot 4	CPU1	PCIe 5.0	x8	x8	PE1	FH 3/4L
Slot 5	CPU1	PCIe 5.0	x16	x16	PE2	FH 3/4L
Slot 6	CPU1	PCIe 5.0	x8	x8	PE3	FH 3/4L
Slot 7	CPU0	PCIe 5.0	x8	x8	PE3	FH 3/4L
OCP 3.0 Slot	CPU0	PCIe 5.0	x16	x16	PE0	Standard OCP 3.0 specs
OCP 3.0 Slot	CPU1	PCIe 5.0	x8/x16	x8/x16	PE0	Standard OCP 3.0 specs

Table 5-14 PCIe Slot Description - Configuration of 10 Rear PCIe Slots

PCIe Slot	Owner	PCIe Standard	Connector Width	Bus Width	Port No.	Form Factor
Slot 0	CPU0	PCIe 5.0	x16	x16	PE2	FHHL
Slot 1	CPU0	PCIe 5.0	x16	x16	PE1	FH 3/4L
Slot 2	CPU0	PCIe 5.0	x16	x16	PE3	FH 3/4L
Slot 3	CPU1	PCIe 5.0	x16	x16	PE1	FHHL
Slot 4	CPU1	PCIe 5.0	x16	x16	PE2	FH 3/4L
Slot 5	CPU0	PCIe 5.0	x16	x16	PE4	FH 3/4L

PCIe Slot	Owner	PCIe Standard	Connector Width	Bus Width	Port No.	Form Factor
Slot 6	CPU1	PCIe 5.0	x8	x8	PE3	HH 3/4L
Slot 7	CPU1	PCIe 5.0	x8	x8	PE3	HH 3/4L
Slot 8	CPU1	PCIe 5.0	x8	x8	PE4	HH 3/4L
Slot 9	CPU1	PCIe 5.0	x8	x8	PE4	HH 3/4L
OCP 3.0 Slot	CPU0	PCIe 5.0	x16	x16	PE0	Standard OCP 3.0 specs
OCP 3.0 Slot	CPU1	PCIe 5.0	x8/x16	x8/x16	PE0	Standard OCP 3.0 specs

Table 5-15 PCIe Slot Description - GPU Configuration

PCIe Slot	Owner	PCIe Standard	Connector Width	Bus Width	Port No.	Form Factor
Slot 0	CPU0	PCIe 5.0	x16	x16	PE2	FHHL
Slot 3	CPU1	PCIe 5.0	x16	x16	PE1	FHHL
OCP 3.0 Slot	CPU0	PCIe 5.0	x16	x16	PE0	Standard OCP 3.0 specs
OCP 3.0 Slot	CPU1	PCIe 5.0	x8/x16	x8/x16	PE0	Standard OCP 3.0 specs

5.8 PSUs

- Supports up to 2 PSUs.
- Supports AC or DC power input.
- The PSUs are hot-swappable.
- The server supports 2 PSUs with 1+1 redundancy.
- The server must use PSUs with the same part number (P/N code).
- The server provides short-circuit protection, and provides PSUs supporting dual-live-wire input.

Figure 5-49 PSU Locations

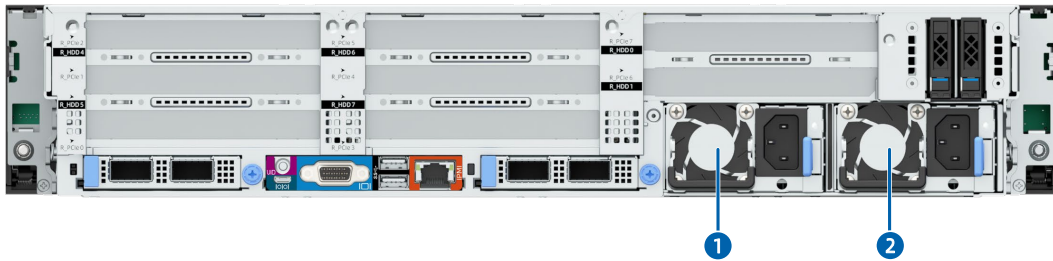

Item	Feature	Item	Feature
1	PSU0	2	PSU1

5.9 Fans

- Supports 6 fans. Users can select 6038 or 6056 fans based on the actual configuration.
- The fans are hot-swappable.
- The server supports fans with N+1 redundancy, which means that the server can continue working properly when a fan fails.
- Supports intelligent fan speed control.
- The server must use fans with the same part number (P/N number).

5.10 LCD Module (Optional)

5.10.1 Function

The LCD module reads server-related information from the BMC, such as the operating status of processors and memories, network status, logs and alerts, and transmits the information to client mobile terminals via Bluetooth.

The LCD module synchronizes information with ISBMC through I²C and can display information on an LCD screen or in the APP. The server's basic information, system status and alert diagnosis can be displayed in the app via Bluetooth (Inspur servers/BMC \leftrightarrow I²C \leftrightarrow LCD module \leftrightarrow Bluetooth \leftrightarrow APP), facilitating the operation and maintenance.

Figure 5-50 How LCD Subsystem Works

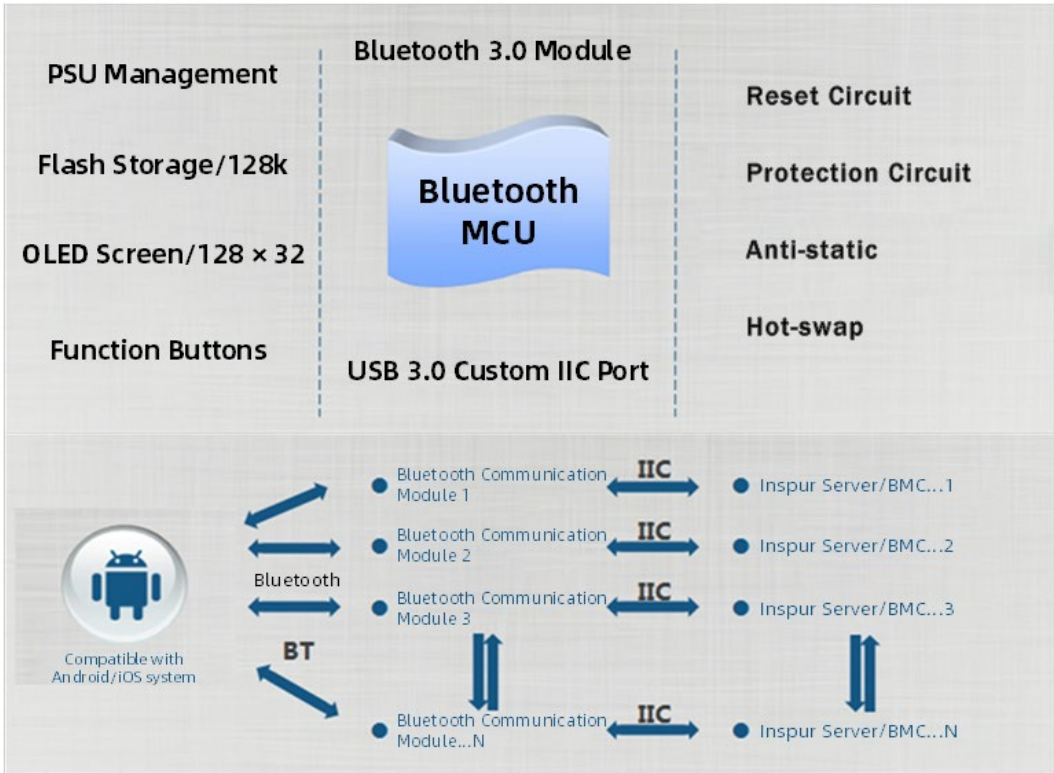

5.10.2 Interface

Figure 5-51 APP Home Screen

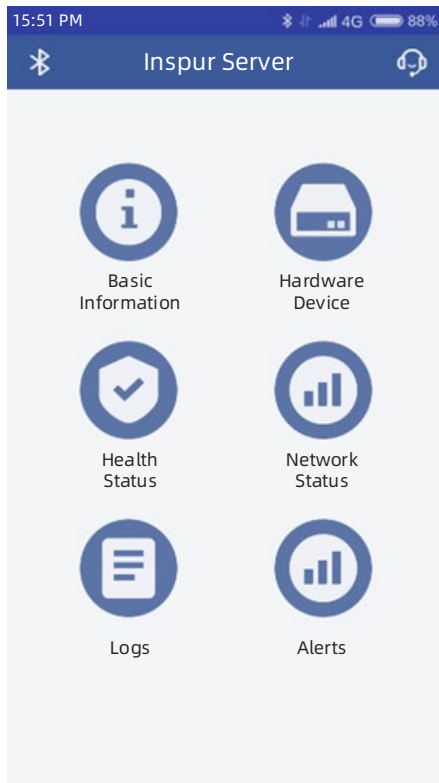

5.11 Boards

5.11.1 Motherboard

Figure 5-52 Motherboard Layout

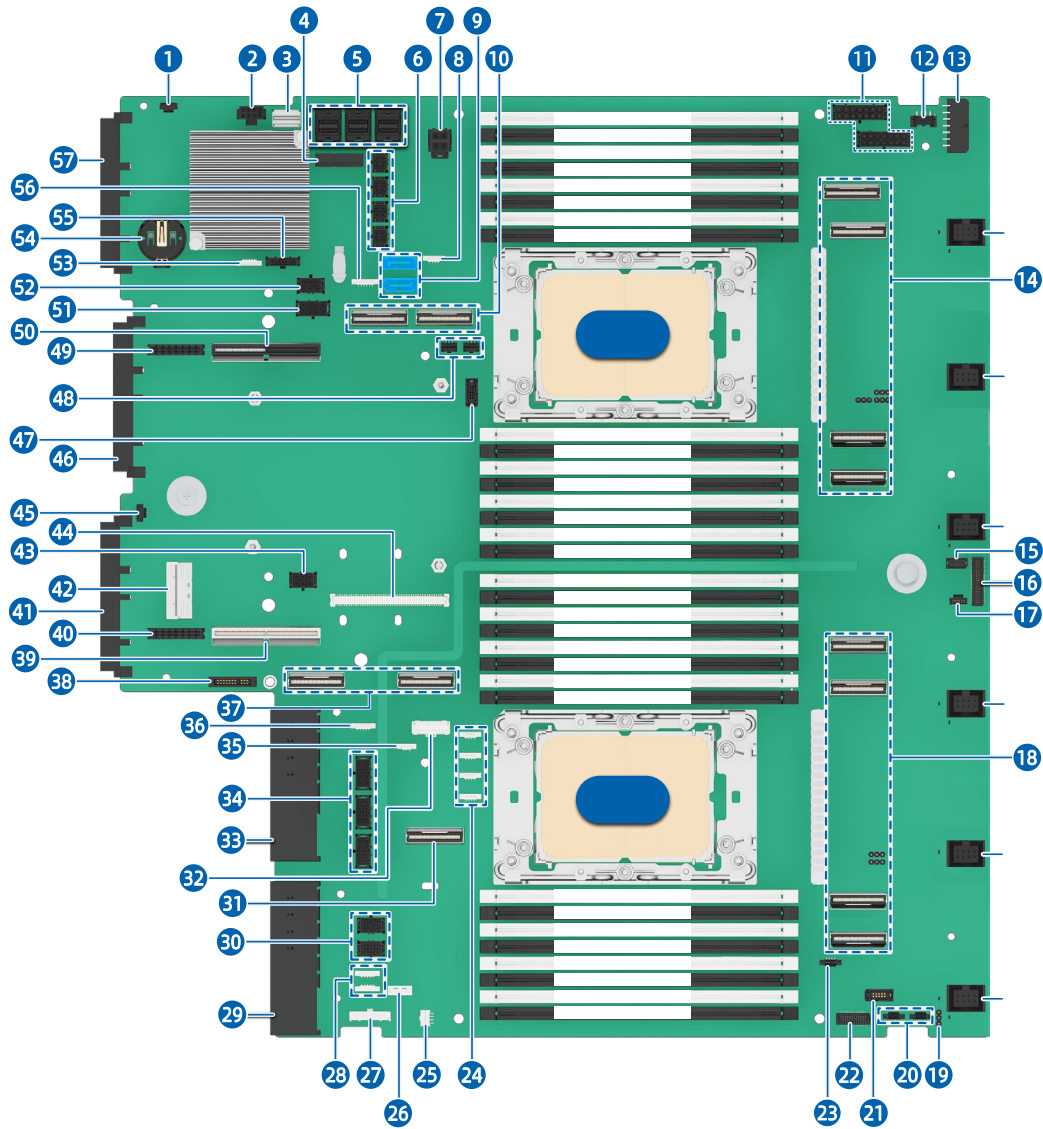

Item	Feature	Item	Feature
1	OCP 3.0_0 Button and LED Connector	2	Mid-Backplane Power Connector
3	Right Control Panel Connector	4	SYS_TF Connector
5	Mini SAS Connector × 3	6	Rear Backplane Power Connector × 4
7	Front OCP Power Connector	8	I ² C Connector
9	SATA Connector × 2	10	MCIO x8 Connector (CPU0) × 2

Item	Feature	Item	Feature
11	Front Backplane Power Connector × 2	12	Sensor Connector
13	Front Backplane Power Connector	14	MCIO x8 Connector (CPU0) × 4
15	Intrusion Switch Connector	16	OCP2 Sideband Signal Connector
17	OCP 3.0_2 Button and LED Connector	18	MCIO x8 Connector (CPU1) × 4
19	CLR_CMOS Jumper	20	Backplane I ² C Connector × 2
21	VPP Connector	22	Left Control Panel Connector
23	Backplane I ² C Connector	24	Backplane I ² C Connector × 4
25	IPMB Connector	26	RAID Key Connector
27	Capacitor Board Connector	28	I ² C Connector × 2
29	PSU1 Connector	30	GPU_Riser Power Connector × 2
31	MCIO x8 Connector (CPU1)	32	NC-SI Connector
33	PSU0 Connector	34	GPU Power Connector × 3
35	Smart NIC UART Connector	36	I ² C Connector
37	MCIO x8 Connector (CPU1) × 2	38	Riser Card Power Connector
39	MCIO x16 Connector (CPU1)	40	Riser Card Power Connector
41	OCP 3.0 Connector	42	OCP 3.0 MCIO Connector (CPU1)
43	GPU_Riser Power Connector	44	OCPA Slot (CPU0)
45	OCP 3.0_1 Button and LED Connector	46	DC-SCM Connector
47	VPP Connector	48	Leak Detection Connector
49	Riser Card Power Connector	50	MCIO x16 Connector (CPU0)
51	GPU0 Power Connector	52	GPU_Riser Power Connector
53	I ² C Connector	54	Button Battery Socket
55	Smart NIC Power Connector	56	SGPIO Connector
57	OCP 3.0 Connector		

5.11.2 Drive Backplanes

1. Front Drive Backplanes

Figure 5-53 4 × 3.5-inch SAS/SATA Drive Backplane

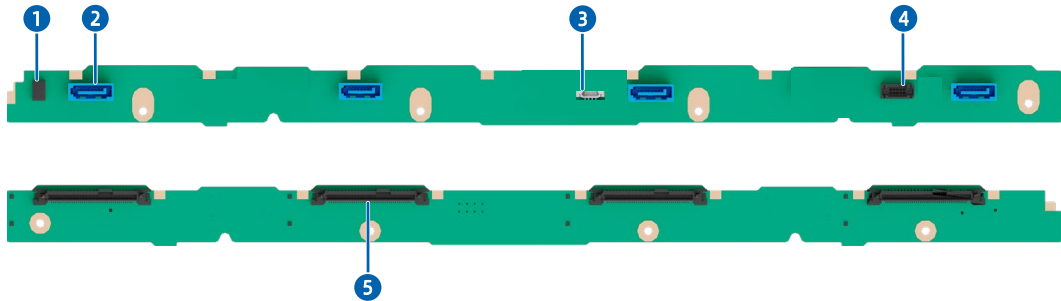

Item	Feature	Item	Feature
1	BMC I ² C Connector	2	SATA Connector
3	SGPIO Connector	4	Backplane Power Connector
5	SAS Connector		

Figure 5-54 4 × 3.5-inch SAS/SATA/NVMe Drive Backplane

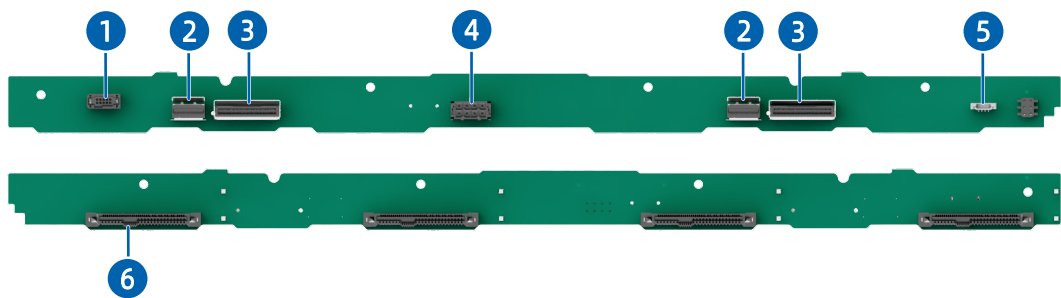

Item	Feature	Item	Feature
1	VPP Connector	2	Slimline x4 Connector × 2
3	MCIO x8 Connector × 2	4	Backplane Power Connector
5	BMC I ² C Connector	6	Drive Connector

Figure 5-55 12 × 3.5-inch SAS/SATA Pass-Through Drive Backplane

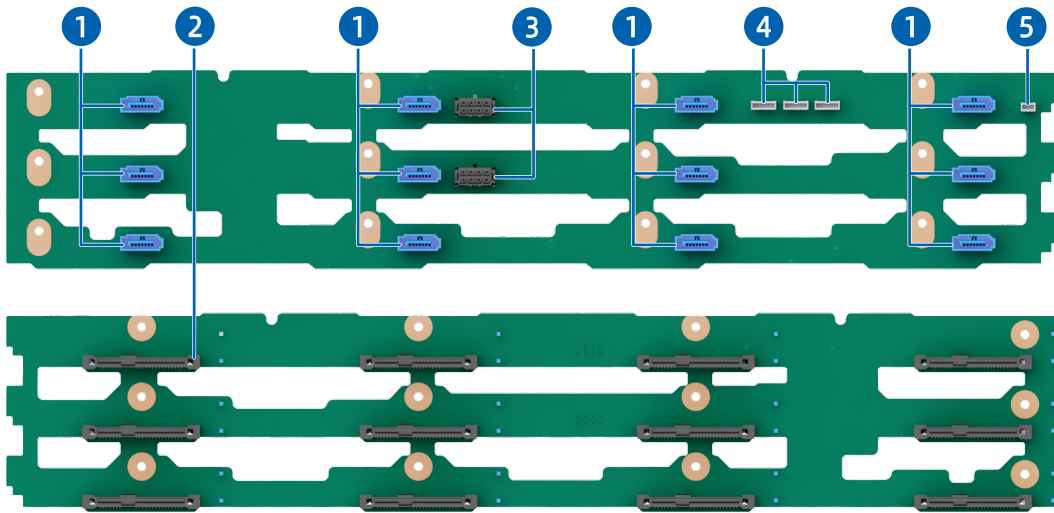

Item	Feature	Item	Feature
1	SATA 7-pin Connector × 12	2	Drive Connector
3	Backplane Power Connector × 2	4	SGPIO Connector × 3
5	BMC I ² C Connector		

Figure 5-56 12 × 3.5-inch SAS/SATA Drive Backplane

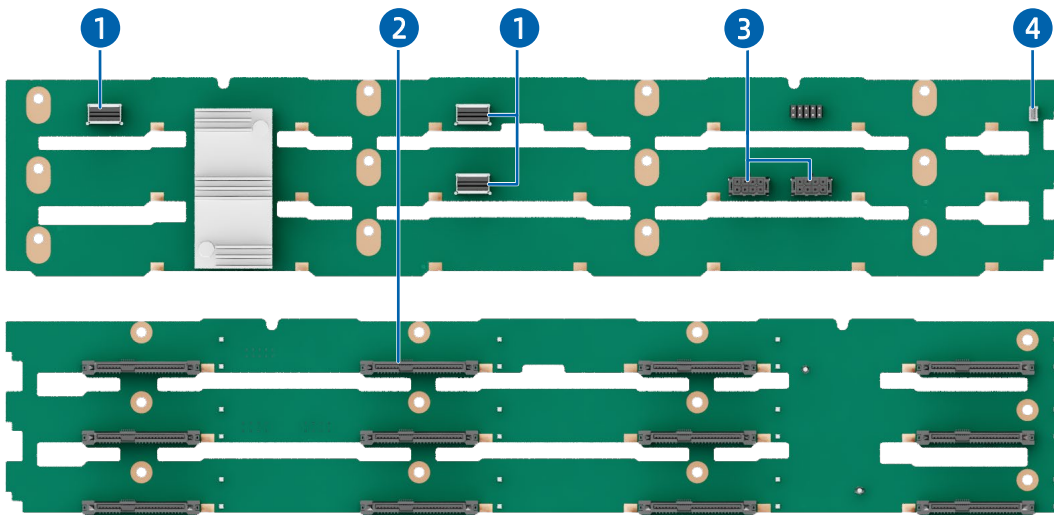

Item	Feature	Item	Feature
1	Slimline x4 Connector × 3	2	Drive Connector
3	Backplane Power Connector × 2	4	BMC I ² C Connector

Figure 5-57 12 × 3.5-inch SAS/SATA Drive Backplane

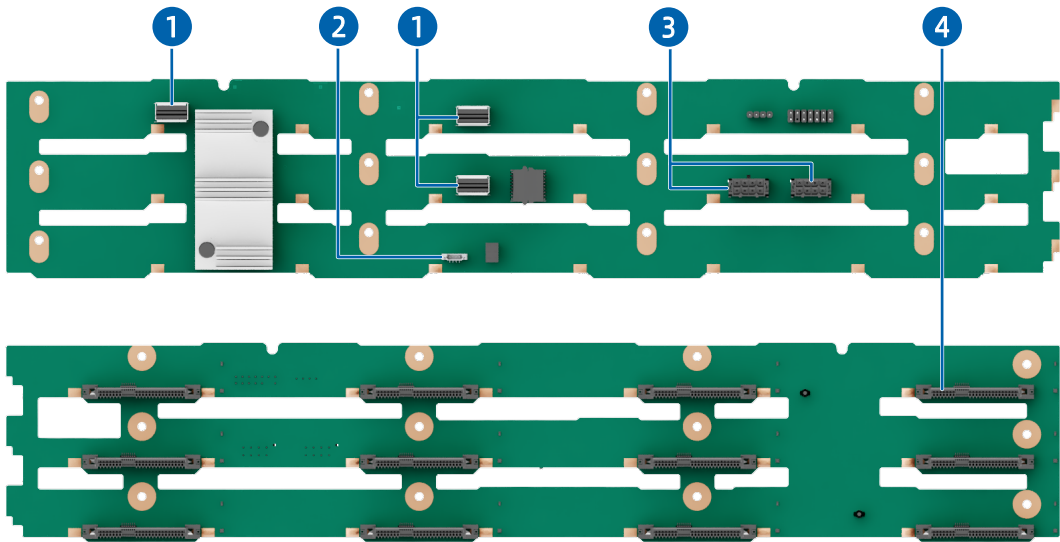

Item	Feature	Item	Feature
1	Slimline x4 Connector × 3	2	BMC I²C Connector
3	Backplane Power Connector × 2	4	Drive Connector

Figure 5-58 21 × SAS/SATA + 4 × SAS/SATA/NVMe Drive Backplane

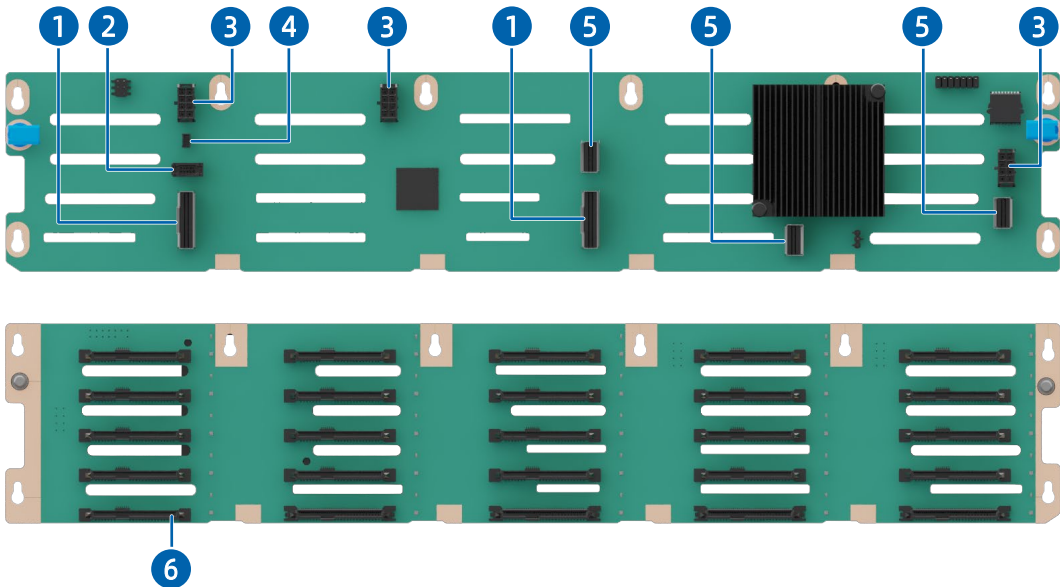

Item	Feature	Item	Feature
1	Slimline x8 Connector × 2	2	VPP Connector
3	Backplane Power Connector × 3	4	BMC I²C Connector
5	Slimline x4 Connector × 3	6	Drive Connector

Figure 5-59 8 × 2.5-inch SAS/SATA/NVMe Drive Backplane

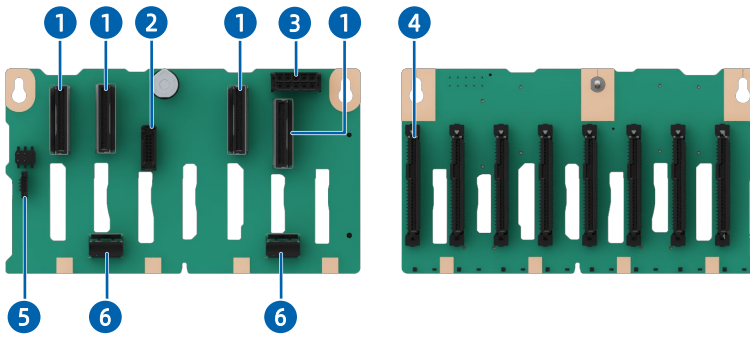

Item	Feature	Item	Feature
1	MCI0 x8 Connector × 4	2	VPP Connector
3	Backplane Power Connector	4	Drive Connector
5	BMC I ² C Connector	6	Slimline x4 Connector × 2

Figure 5-60 6 × SAS/SATA + 2 × SAS/SATA/NVMe Drive Backplane

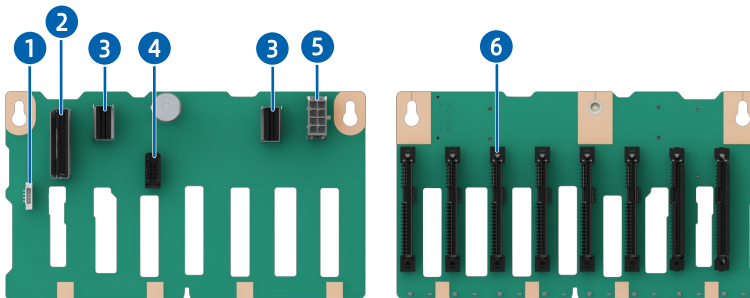

Item	Feature	Item	Feature
1	BMC I ² C Connector	2	MCI0 x8 Connector
3	Slimline x4 Connector × 2	4	VPP Connector
5	Backplane Power Connector	6	Drive Connector

Figure 5-61 8 × 2.5-inch NVMe Drive Backplane

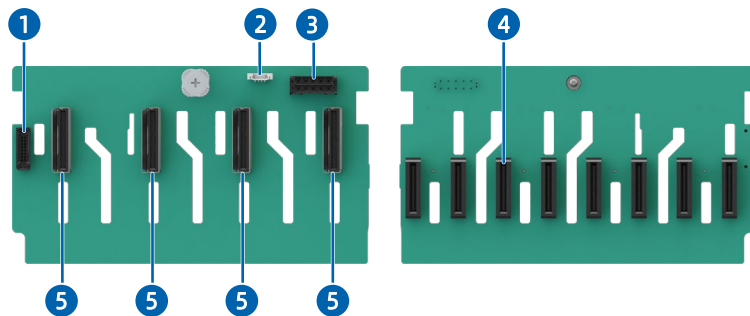

Item	Feature	Item	Feature
1	VPP Connector	2	BMC I ² C Connector
3	Backplane Power Connector	4	Drive Connector
5	MCIO x8 Connector × 4		

2. Rear Drive Backplanes

Figure 5-62 2 × 3.5-inch SAS/SATA Drive Backplane

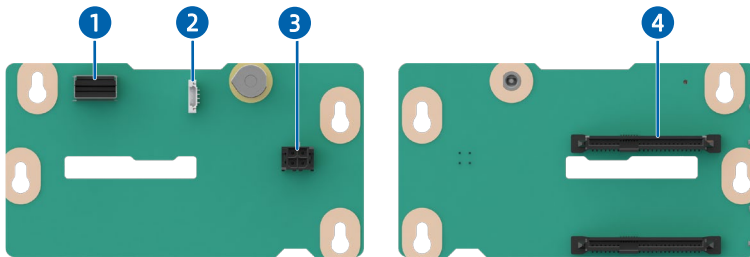

Item	Feature	Item	Feature
1	Slimline x4 Connector	2	BMC I ² C Connector
3	Backplane Power Connector	4	Drive Connector

Figure 5-63 2 × 2.5-inch NVMe Drive Backplane

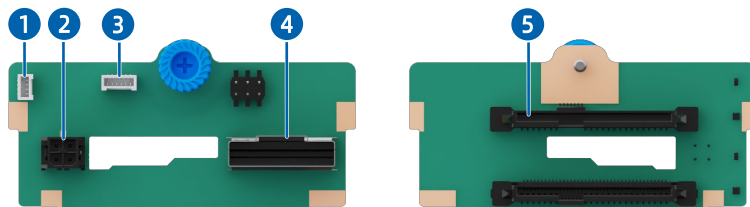

Item	Feature	Item	Feature
1	BMC I ² C Connector	2	Backplane Power Connector
3	SGPIO Connector	4	Slimline x8 Connector
5	Drive Connector		

Figure 5-64 2 × 2.5-inch SAS/SATA Drive Backplane

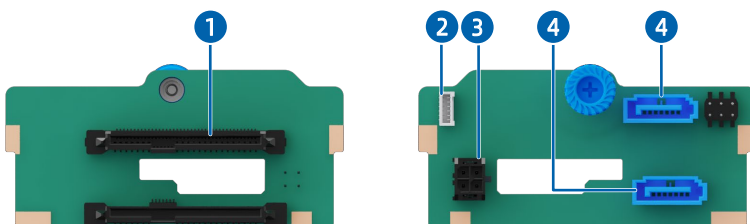

Item	Feature	Item	Feature
1	Drive Connector	2	BMC I ² C Connector
3	Backplane Power Connector	4	SATA 7-pin Connector × 2

Figure 5-65 2 × M.2 SSD Backplane

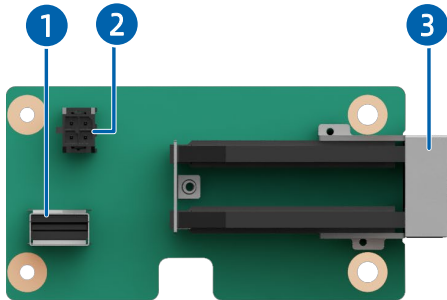

Item	Feature	Item	Feature
1	Slimline x4 Connector	2	Backplane Power Connector
3	M.2 Drive Connector		

6 System Specifications

6.1 Technical Specifications

Table 6-1 Technical Specifications

Item	Description
Form Factor	2U rack server
Chipset	Intel Emmitsburg
Processor	<p>Up to two 4th Gen Intel Xeon Scalable processors (Sapphire Rapids/Emerald Rapids)</p> <ul style="list-style-type: none">• Integrated memory controllers and 8 memory channels per processor• Integrated PCIe controllers and 80 PCIe 5.0 lanes per processor• Up to 4 UPI links per CPU at up to 20 GT/s• Up to 64 cores• Maximum Turbo frequency at 4.5 GHz• TDP up to 350 W <p>Note: The information above is for reference only, refer to 7.2 Hardware Compatibility for details.</p>
Memory	<ul style="list-style-type: none">• 32 DIMM slots• 8 memory channels per processor and up to 2 DIMMs per channel• Speed up to 4,800 MT/s• Supports RDIMM and CPS <p>Note: The information above is for reference only, refer to 7.2 Hardware Compatibility for details.</p>
Storage	<p>Supports multiple drive configurations, see 5.5.1 Drive Configurations for details.</p> <ul style="list-style-type: none">• Supports 2 onboard M.2 SATA SSDs <p>Notes:</p>

Item	Description
	<ul style="list-style-type: none"> • It is recommended that the M.2 SSD is only used as a boot device for installing the OS. • The M.2 SSD has low endurance and cannot be used as a data storage device, especially in scenarios with frequent data erasing and re-writing. The reason is that write limits can be reached within a short period of time, which will result in damage and unavailability. • For data storage, use enterprise-class SSDs with higher DWPD or HDDs. • Write-intensive business software will cause the M.2 SSD to reach write endurance and wear out; therefore, the M.2 SSD is not recommended for such business scenarios. • Do not use the M.2 SSD as caching. <p>• Supports hot-swap SAS/SATA/NVMe drives</p> <p>Notes: When the server is configured with NVMe drives:</p> <ul style="list-style-type: none"> • When the VMD function is enabled and the latest VMD driver is installed, the NVMe drives support surprise hot swap. • Supports multiple models of RAID controller cards. See 7.2 Hardware Compatibility for details. <ul style="list-style-type: none"> - Supports functions such as RAID configuration, RAID level migration, and disk roaming. - Supports power failure protection enabled by the super-capacitor to protect user data. - A standard RAID controller card occupies 1 PCIe slot.
Network	<p>Supports multiple network expansion configurations.</p> <ul style="list-style-type: none"> • OCP 3.0 cards <ul style="list-style-type: none"> - 2 OCP 3.0 cards supported in 2 slots (on-demand selection) - Supports balanced mode and NC-SI feature under dual-CPU configuration - Hot-pluggable - Supports multi-host (only OCP1 NIC slot) <p>Note: Redhat 7.9 supports hot-swap; Windows 2019 supports hot-swap when it starts up with the OCP 3.0 card installed; Redhat 8.X OS does not support hot-swap.</p> <ul style="list-style-type: none"> • 1/10/25/40/100 Gb PCIe NICs
I/O Expansion	<p>Supports PCIe expansion slots.</p> <ul style="list-style-type: none"> • For servers with rear PCIe riser modules: 2 dedicated expansion slots for the OCP 3.0 card and 8 standard PCIe expansion slots.

Item	Description
	<ul style="list-style-type: none"> Refer to 5.7.2 PCIe Slots and 5.7.3 PCIe Slot Description for details.
Port	<p>Supports multiple ports.</p> <ul style="list-style-type: none"> Front: <ul style="list-style-type: none"> 1 × USB 2.0 port 1 × USB 3.0 port 1 × DB15 VGA port 1 × USB Type-C port Rear: <ul style="list-style-type: none"> 2 × USB 3.0 port 1 × DB15 VGA port 1 × serial port (micro USB) 1 × RJ45 management network port <p>Note: OS installation on the USB storage media is not recommended.</p>
Display	<p>Integrated VGA with a video memory of 64 MB and a maximum 16M color resolution of 1,920 × 1,200 at 60 Hz.</p> <p>Notes:</p> <ul style="list-style-type: none"> The integrated VGA can support a maximum resolution of 1,920 × 1,200 only when the video driver matching the OS version is installed; otherwise only the default resolution of the OS is supported. When the front and rear VGA ports are both connected to monitors, only the monitor connected to the front VGA port works.
System Management	<ul style="list-style-type: none"> UEFI ISBMC NC-SI Inspur Physical Infrastructure Manager
Security	<ul style="list-style-type: none"> Intel Platform Firmware Resilience (PFR) Trusted Platform Module (TPM) 2.0 and Trusted Cryptography Module (TCM) Intel Trusted Execution Technology Firmware update mechanism based on digital signatures

Item	Description
	<ul style="list-style-type: none"> • UEFI Secure Boot • Hierarchical BIOS password protection • BIOS Secure Flash and BIOS Lock Enable (BLE) • BMC and BIOS dual-image mechanism • Chassis intrusion detection

6.2 Environmental Specifications

Table 6-2 Environmental Specifications

Parameter	Description
Temperature ^{1,2,3}	<ul style="list-style-type: none"> • Operating: 5°C to 45°C (41°F to 113°F) • Storage (packed): -40°C to +70°C (-40°F to +158°F) • Storage (unpacked): -40°C to +55°C (-40°F to +131°F)
Relative Humidity (RH, non-condensing)	<ul style="list-style-type: none"> • Operating: 5% to 90% RH • Storage (packed): 5% to 93% RH • Storage (unpacked): 5% to 93% RH
Operating Altitude	<p>≤ 3050 m (10,007 ft)</p> <ul style="list-style-type: none"> • 0 to 1,000 m (0 to 3,281 ft): Operating temperature ranges from 0°C to 40°C (32°F to 104°F) • 1,000 to 3,050 m (3,281 to 10,007 ft): Operating temperature ranges from 5°C to 32°C (5°F to 89.6°F)
Corrosive Gaseous Contaminants	<p>Maximum growth rate of corrosion film thickness:</p> <ul style="list-style-type: none"> • Copper coupon: 300 Å/month (compliant with the gaseous corrosivity level of G1 defined in ANSI/ISA-71.04-2013) • Silver coupon: 200 Å/month (compliant with the gaseous corrosivity level of G1 defined in ANSI/ISA-71.04-2013)

Parameter	Description
Acoustic Noise ^{4,5,6}	<p>Noise emissions are measured in accordance with ISO 7779 (ECMA 74) and declared in accordance with ISO 9296 (ECMA 109). Listed are the declared A-weighted sound power levels (LWAd) and declared average bystander position A-weighted sound pressure levels (LpAm) at a server operating temperature of 23°C (73.4°F):</p> <ul style="list-style-type: none"> • Idle: <ul style="list-style-type: none"> - LWAd: 5.8 B for standard configuration - LpAm: 49.0 dBA for standard configuration • Operating: <ul style="list-style-type: none"> - LWAd: 6.4 B for standard configuration - LpAm: 53 dBA for standard configuration

Notes:

1. Not all configurations support an operating temperature range of 5°C to 45°C (41°F to 113°F). GPU configurations support an operating temperature range of 10°C to 30°C (50°F to 86°F).
2. Standard operating temperature:
 - 10°C to 35°C (50°F to 95°F) is the standard operating temperature range at sea level. For temperatures between 10°C and 35°C (50°F and 95°F), derate the maximum allowable temperature by 1°C per 305 m (1°F per 556 ft) above sea level. No direct sustained sunlight is permitted. The maximum operating altitude is 3,050 m (10,007 ft) and the maximum temperature gradient is 20°C/h (36°F/h), both varying with different system configurations.
 - Any fan failure or operations above 30°C (86°F) may lead to system performance degradation.
3. Expanded operating temperature:
 - For certain approved configurations, the supported system inlet ambient temperature can be expanded to 5°C to 10°C (41°F to 50°F) and 35°C to 45°C (95°F to 113°F) at sea level. At an altitude of 900 to 3,050 m (2,953 to 10,007 ft), derate the maximum allowable operating temperature by 1°C per 175 m (1°F per 319 ft).

- For certain approved configurations, the supported system inlet ambient temperature can be expanded to 35°C to 45°C (95°F to 113°F) at sea level. At an altitude of 900 to 3,050 m (2,953 to 10,007 ft), derate the maximum allowable temperature by 1°C per 125 m (1°F per 228 ft).
 - Any fan failure or operations under expanded operating temperature may lead to system performance degradation.
4. This document lists the LWAd and LpAm of the product at a 23°C (73.4°F) ambient environment. All measurements are conducted in conformance with ISO 7779 (ECMA 74) and declared in conformance with ISO 9296 (ECMA 109). The listed sound levels apply to the standard configuration. Additional options may result in increased sound levels. Contact your sales representative for more information.
 5. The sound levels shown here were measured based on specific configurations of a server. Sound levels vary with server configuration. These values are for reference only and subject to change without further notice.
 6. Product conformance to cited normative standards is based on sample testing, evaluation, or assessment. This product or family of products is eligible to bear the appropriate compliance logos and statements.

6.3 Physical Specifications

Table 6-3 Physical Specifications

Item	Description
Dimensions (W × H × D)	<ul style="list-style-type: none"> • With mounting ears: 482.4 × 87 × 828.4 mm (19 × 3.43 × 32.61 in.) • Without mounting ears: 435 × 87 × 800 mm (17.13 × 3.43 × 31.5 in.) • Outer packaging: 600 × 295 × 1090 mm (23.62 × 11.61 × 42.91 in.)
Installation Dimension Requirements	<ul style="list-style-type: none"> • Installation requirements for the cabinet are as follows: <ul style="list-style-type: none"> - General cabinet compliant with the International Electrotechnical Commission 297 (IEC 297) standard - Width: 482.6 mm (19 in.) - Depth: Above 1,000 mm (39.37 in.) • Installation requirements for the server rails are as follows:

Item	Description
	<ul style="list-style-type: none"> - L-bracket rails: applicable to Inspur cabinets only - Static rail kit: The distance between the mounting flanges at the front and rear of the cabinet ranges from 609 to 914 mm (23.98 to 35.98 in.) - Ball-bearing rail kit: The distance between the mounting flanges at the front and rear of the cabinet ranges from 609 to 914 mm (23.98 to 35.98 in.) - When the CMA is selected, the cabinet depth should be above 1,200 mm (47.24 in.)
Weight	<ul style="list-style-type: none"> • 25 × 2.5-inch drive configuration (with 25 drives loaded) <ul style="list-style-type: none"> - Net weight: 30 kg (66.14 lbs) - Gross weight: 40 kg (88.18 lbs) (including chassis + packaging, rails and accessory box) • 24 × 2.5-inch drive configuration (with 24 drives loaded) <ul style="list-style-type: none"> - Net weight: 27 kg (59.52 lbs) - Gross weight: 37 kg (81.57 lbs) (including chassis + packaging, rails and accessory box) • 12 × 3.5-inch drive configuration (with 12 drives and 2 GPUs loaded) <ul style="list-style-type: none"> - Net weight: 33 kg (72.75 lbs) - Gross weight: 43 kg (94.8 lbs) (including chassis + packaging, rails and accessory box)

7 Operating System and Hardware Compatibility

This section describes the OS and hardware compatibility of the server. For the latest compatibility configuration and the component models not listed in this document, contact your local Inspur sales representative.

IMPORTANT

- Using incompatible components may cause the server to work abnormally, and such failures are not covered by technical support or warranty.
 - The server performance is strongly influenced by application software, middleware and hardware. The subtle differences in them may lead to performance variation in the application and test software.
 - For requirements on the performance of specific application software, contact Inspur sales representatives to request for a proof of concept (POC) and confirm the detailed hardware and software configurations during the pre-sales phase.
 - For requirements on hardware performance consistency, define specific configuration requirements (for example, specific drive models, RAID controller cards, or firmware versions) during the pre-sales phase.
-

7.1 Supported Operating Systems

Table 7-1 Supported Operating Systems

OS	OS Version
Red Hat	Red Hat Enterprise Linux 9.0
SUSE	SLES 15.4
Ubuntu	Ubuntu 22.04.01

7.2 Hardware Compatibility

7.2.1 CPU Specifications

The server supports up to two 4th Gen Intel Xeon Scalable processors (Sapphire Rapids/Emerald Rapids) based on the Eagle Stream platform.

Table 7-2 CPU Specifications

Model	Cores	Threads	Base Frequency (GHz)	Max Turbo Frequency (GHz)	Cache (MB)	TDP (W)
6454S	32	64	2.2	3.4	60	270
8470	52	104	2.0	3.8	105	350
6416H	18	36	2.2	4.2	45	165
6418H	24	48	2.1	4.0	60	185

7.2.2 DIMM Specifications

The server supports up to 32 DDR5 DIMMs. Each processor supports 8 memory channels with up to 2 DIMMs per channel. The supported DIMMs includes RDIMMs and CPS.

Table 7-3 DIMM Specifications

Type	Capacity (GB)	Frequency (MHz)	Data Width	Organization
RDIMM	16	4,800	x80	1R x8
RDIMM	32	4,800	x80	1R x4/2R x8
RDIMM	64	4,800	x80	2R x4
CPS	128	4,800		

7.2.3 Drive Specifications

Table 7-4 SAS/SATA Drive Specifications

Type	Speed in rpm	Capacity	Max Qty.
2.5-inch SAS	10K	600 GB/1.2 TB/1.8 TB/2.4 TB	39
	15K	600 GB/900 GB	39

Table 7-5 SSD Specifications

Type	Capacity	Max Qty.
SATA SSD	240 GB	39
SATA SSD	480 GB	39
SATA SSD	960 GB	39

SATA SSD	1.9 TB	39
SATA SSD	3.8 TB	39
SAS SSD	960 GB	39
SAS SSD	1.9 TB	39
SAS SSD	3.8 TB	39

Table 7-6 U.2 NVMe SSD Specifications

Type	Capacity	Max Qty.
U.2 NVMe SSD	960 GB	32
U.2 NVMe SSD	1 TB	32
U.2 NVMe SSD	1.6 TB	32
U.2 NVMe SSD	1.9 TB	32
U.2 NVMe SSD	2 TB	32
U.2 NVMe SSD	3.2 TB	32
U.2 NVMe SSD	3.8 TB	32
U.2 NVMe SSD	4 TB	32
U.2 NVMe SSD	6.4 TB	32
U.2 NVMe SSD	8 TB	32

Table 7-7 M.2 SSD Specifications

Type	Capacity	Max Qty.
M.2 SATA SSD	240 GB	2
M.2 SATA SSD	480 GB	2
M.2 SATA SSD	960 GB	2
M.2 PCIe SSD	960 GB	2
M.2 PCIe SSD	1.9 TB	2
M.2 PCIe SSD	3.8 TB	2

7.2.4 SAS/RAID Controller Card Specifications

Table 7-8 SAS/RAID Controller Card Specifications

Type	Manufacturer	Description
SAS Controller Card	Inspur	SAS Controller Card_Inspur_PM8222_PM8222_8_SAS3_PCIE
		SAS Controller Card_Inspur_PM8222_SmartHBA_8_SAS3_PCIE3
	Inspur	RAID Controller Card_Inspur_PM8204_RA_8_2GB_SAS3_PCIE3

Type	Manufacturer	Description
RAID Controller Card		RAID Controller Card_Inspur_PM8204_RA_8_4GB_SAS3_PCIE3
		RAID Controller Card_Inspur_MT0804M6R_Mezz Card
		RAID Controller Card_Inspur_MT0808M6R_Mezz Card



NOTE

- Drive numbers may be out of order if SAS/RAID controller cards from different manufacturers are used.
- Drive numbers may be out of order if front drives use SAS/RAID controller cards and rear M.2 drives directly connected to PCH are configured.

7.2.5 NIC Specifications

Table 7-9 OCP NIC Specifications

Type	Description	Speed (Gb)	Port Qty.
OCP 3.0 Card	NIC_I_1G_I350T4_RJ_OCP3x4_4_XR	1	4
	NIC_I_25G_E810XXVDA2_LC_OCP3x8_2_XR	25	2
	NIC_Inspur_Andes-M6_E810_25G_LC_OCP3x8_2	25	2
	NIC_M_100G_MCX623436AN_LC_OCP3x16_2_XR	100	2

Table 7-10 PCIe NIC Specifications

Type	Description	Speed (Gb)	Port Qty.
PCIe NIC	NIC_Intel_W_I350-T2V2_RJ_PCI-E4X_1KM_Dual	1	2
	NIC_I_10G_X710DA2_LC_PCIEx8_2_XR	10	2
	NIC_M_25G_MCX631102AN_LC_PCIEx8_2_XR	25	2
	NIC_BROADCM_25G_57414_LC_PCIEx8_2_XR_42C	25	2
	NIC_M_100G_MCX623106AN_LC_PCIEx16_2_XR	100	2

7.2.6 PSU Specifications

The server supports up to 2 PSUs in 1+1 redundancy that follow the Intel Common Redundant Power Supply (CRPS) specification. The PSUs share a common electrical and structural design that allows for hot-swap and tool-less installation into the

server with the PSUs locking automatically after being inserted into the power bay. The CRPS PSUs are 80 Plus Platinum or Titanium rated with various output powers, allowing customers to choose as needed.

- The following rated 110 VAC to 230 VAC and 240 VDC PSUs in 1+1 redundancy are supported:
 - 800 W Platinum PSU: 800 W (110 VAC), 800 W (230 VAC), 800 W (240 VDC for China)
 - 1,300 W Platinum PSU: 1,000 W (110 VAC), 1,300 W (230 VAC), 1,300 W (240 VDC for China)
 - 1,600 W Platinum PSU: 1,000 W (110 VAC), 1,600 W (230 VAC), 1,600 W (240 VDC for China)
 - 2,000 W Platinum PSU: 1,000 W (110 VAC), 2,000 W (230 VAC), 2,000 W (240 VDC for China)
 - 2,700 W Platinum PSU: 1,200 W (110 VAC), 2,700 W (230 VAC), 2,700 W (240 VDC for China)
 - 800 W Titanium PSU: 800 W (230 VAC), 800 W (240 VDC for China)
 - 1,300 W Titanium PSU: 1,000W (110 VAC), 1,300 W (230 VAC), 1,300 W (240 VDC for China)
 - 1,600 W Titanium PSU: 1,000W (110 VAC), 1600 W (230 VAC), 1600 W (240 VDC for China)
 - 2,000 W Titanium PSU: 1,000W (110 VAC), 2000 W (230 VAC), 2000 W (240 VDC for China)



NOTE

At a rated input voltage of 110 VAC, the output power of a 1,300/1,600/2,000 W PSU will be derated to 1,000 W, and the output power of a 2,700 W PSU will be derated to 1,200 W.

Operating voltage range:

- 110 to 230 VAC: 90 to 264 VAC
- 240 VDC: 180 to 320 VDC
- The following rated 336 VDC PSUs in 1+1 redundancy are supported:
 - 800 W PSU: 800 W (336 VDC)
 - 1,300 W PSU: 1,300 W (336 VDC)

Operating voltage range:

- 336 VDC: 260 to 400 VDC
- 230 VDC: 176 to 264 VDC
- The following rated -48 VDC PSUs in 1+1 redundancy are supported:
 - 800 W PSU: 800 W (-48 VDC)
 - 1,300 W PSU: 1,300 W (-48 VDC)

Operating voltage range:

- -48 VDC: -40 to -72 VDC

8 Regulatory Information

8.1 Safety

8.1.1 General

- Strictly comply with local laws and regulations while installing the equipment. The safety instructions in this section are only a supplement to local safety regulations.
- To ensure personal safety and to prevent damage to the equipment, all personnel must strictly observe the safety instructions in this section and on the device labels.
- People performing specialized activities, such as electricians and electric forklift operators, must possess qualifications recognized by the local government or authorities.

8.1.2 Personal Safety

- Only personnel certified or authorized by Inspur are allowed to perform the installation procedures.
- Stop any operation that could cause personal injury or equipment damage. Report to the project manager and take effective protective measures.
- Working during thunderstorms, including but not limited to handling equipment, installing cabinets and installing power cords, is forbidden.
- Do not carry the weight over the maximum load per person allowed by local laws or regulations. Arrange appropriate installation personnel and do not overburden them.
- Installation personnel must wear clean work clothes, work gloves, safety helmets and safety shoes, as shown in [Figure 8-1](#).

Figure 8-1 Protective Clothing



- Before touching the equipment, put on ESD clothes and ESD gloves or an ESD wrist strap, and remove any conductive objects such as wrist watches or metal jewelry, as shown in [Figure 8-2](#), in order to avoid electric shock or burns.

Figure 8-2 Removing Conductive Objects

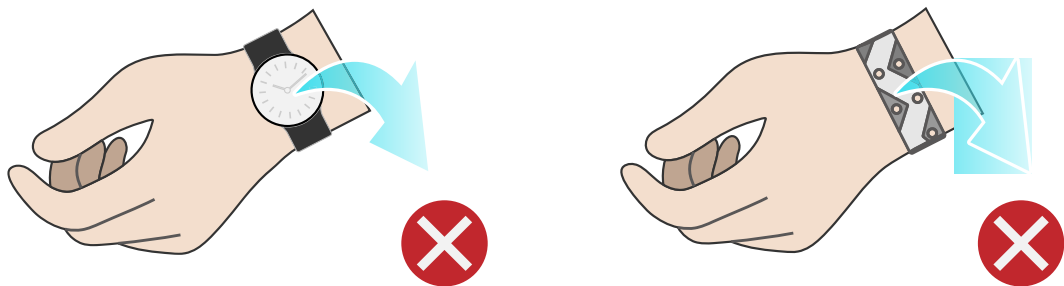

How to put on an ESD strap ([Figure 8-3](#)).

- Put your hand through an ESD wrist strap.
- Tighten the strap buckle to ensure a snug fit.
- Plug the alligator clip of the ESD wrist strap into the corresponding jack on the grounded cabinet or grounded chassis.

Figure 8-3 Wearing an ESD Wrist Strap

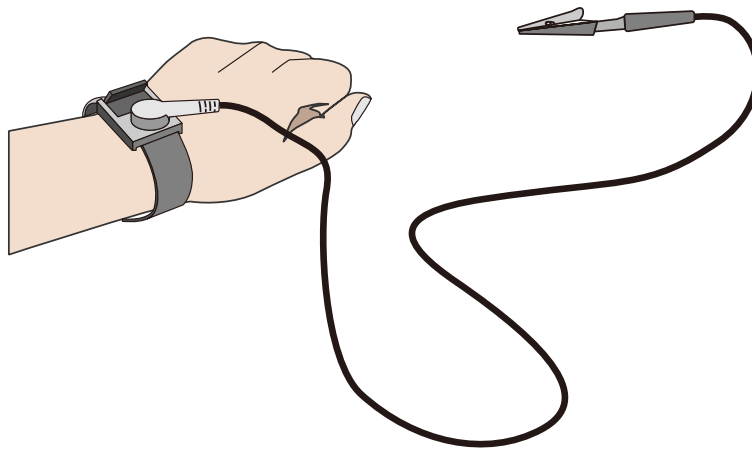

- Use tools correctly to avoid personal injury.
- When moving or lifting equipment above shoulder height, use lifting devices and other tools as necessary to avoid personal injury or equipment damage due to equipment slippage.
- The power sources of the server carry a high voltage. Direct contact or indirect contact through damp objects with the high-voltage power source is fatal.
- To ensure personal safety, ground the server before connecting power.
- When using ladders, always have someone hold and guard the bottom of the ladders. In order to prevent injury, never use a ladder alone.
- When connecting, testing or replacing optical fiber cable, avoid looking into the optical port without eye protection in order to prevent eye damage from laser light.

8.1.3 Equipment Safety

- To ensure personal safety and prevent equipment damage, use only the power cords and cables that come with the server. Do not use them with any other equipment.
- Before touching the equipment, put on ESD clothing and ESD gloves to prevent static electricity from damaging the equipment.
- When moving the server, hold the bottom of the server. Do not hold the handles of any module installed in the server, such as PSUs, fan modules, drive modules, or motherboard. Handle the equipment with care at all times.
- Use tools correctly to avoid damage to the equipment.
- Connect the power cords of active and standby PSUs to different PDUs to ensure high system reliability.

- To ensure equipment safety, always ground the equipment before powering it on.

8.1.4 Transportation Precautions

Contact the manufacturer for precautions before transportation as improper transportation may damage the equipment. The precautions include but not limited to:

- Hire a trusted logistics company to move all equipment. The transportation process must comply with international transportation standards for electronic equipment. Always keep the equipment being transported upright. Avoid collision, moisture, corrosion, packaging damage or contamination.
- Transport the equipment in its original packaging.
- If the original packaging is unavailable, separately package heavy and bulky components (such as chassis, blade servers and blade switches), and fragile components (such as optical modules and PCIe cards).
- Power off all equipment before shipping.

8.1.5 Manual Handling Weight Limits



CAUTION

Observe local laws or regulations regarding the manual handling weight limits per person. The limits shown on the equipment and in the document are recommendations only.

[Table 8-1](#) lists the manual handling weight limits per person specified by some organizations.

Table 8-1 Manual Handling Weight Limits per Person

Organization	Weight Limit (kg/lbs)
European Committee for Standardization (CEN)	25/55.13
International Organization for Standardization (ISO)	25/55.13
National Institute for Occupational Safety and Health (NIOSH)	23/50.72
Health and Safety Executive (HSE)	25/55.13
Administration of Quality Supervision, Inspection and Quarantine of the People's Republic of China (AQSIQ)	<ul style="list-style-type: none"> • Male: 15/33.08 • Female: 10/22.05

9 Inspur Limited Warranty

This limited warranty applies only to the original purchasers of Inspur's products who are direct customers or distributors of Inspur ("Customer").

Inspur warrants all Inspur-branded hardware products, if properly used and installed, to be free from defects in material and workmanship within the warranty period. The term "Inspur Hardware Product" is limited to the hardware components and required firmware. The term "Inspur Hardware Product" DOES NOT include software applications or programs, non-Inspur products, or non-Inspur branded peripherals. Inspur may, at its discretion, repair or replace the defective parts. Repair or replacement parts may be new, used, or equivalent to new in performance and reliability. Repair or replacement parts are warranted to be free of defects in material or workmanship for ninety (90) calendar days or for the remainder of the warranty period of the product, whichever is longer.

Any warranty services of Inspur equipment are not provided by default outside China's mainland, and global customers may purchase corresponding service products on demand.

Service offerings may vary by geographic region. Please contact your Inspur representative to identify service levels and needs for your region.

9.1 Warranty Service

Inspur warranty service includes 24 × 7 remote technical support, RMA (Return Material Authorization) Service, ARMA (Advanced Return Material Authorization) Service, 9 × 5 × NBD (Next Business Day) Onsite Service and 24 × 7 × 4 Onsite Service.

9.1.1 Remote Technical Support

The 24 × 7 remote technical support can be obtained through hotline, e-mail, and Service Portal*¹. Through hotline and e-mail support, Inspur engineers help customers diagnose the causes of malfunctions and provide solutions. Service Portal*¹ provides access to firmware, customized update files, and related manuals for Inspur Hardware Products. Customer may also access the Service Portal*¹ to submit an RMA request or an ARMA request for parts replacement or repair.

Information needed when requesting support:

- Contact name, phone number, e-mail address
- System serial number, part number, model and location (address) of the product needing service

- Detailed description of problem, logs (SEs and blackbox logs, and any other related logs from OS), screenshot of issue, pictures of damaged/faulty parts, etc.

Table 9-1 Support Contact Information

Type	Description	Support Window
Global Hotline	<ul style="list-style-type: none"> • Global: (+1) 844-860-0011/(+1) 325-880-0011 • China: (+86) 400-860-0011 • CIS: (+7) 499-371-3961 • Germany: (+49) 800-850-0011/(+49) 7112-064-9400 • Japan: (+81) 0800-600-0118/(+81) 0505-840-2667 • Korea: (+82) 80-560-0011/(+82) 70-4228-7340 	24 × 7 × 365
Email	<ul style="list-style-type: none"> • Global: serversupport@inspur.com • China: lckf@inspur.com • CIS: serversupport_ru@inspur.com • Germany: serversupport_de@inspur.com • Japan: serversupport_jp@inspur.com • Korea: serversupport_kr@inspur.com • US: serversupportusa@inspur.com 	24 × 7 × 365

9.1.2 RMA Service

Standard Replacement: When a hardware failure occurs, Customer may submit an RMA request to Inspur via e-mail or Service Portal*1. Inspur will review and approve the RMA submission at its own discretion, and provide an RMA number and return information that Customer may use to return the defective part(s) for the RMA service. Inspur will ship out replacement part(s) within one (1) business day after receiving the defective part(s) and cover one-way shipment.



- Customer should return the defective parts in their original packaging to the

Inspur designated service center at their own expense.

- After Inspur's further diagnosing and testing, if the defective parts conform to Inspur's repair policy, Inspur will ship out the repair or replacement parts at our own expense; otherwise, Inspur will return the defective parts at Customer's expense.
 - If Customer needs to designate a logistics company, allocation of the shipping cost to Inspur/Customer will be redefined.
-

9.1.3 ARMA Service

Advanced Replacement: If a problem with Inspur Hardware products cannot be resolved via hotline or e-mail support and replacement part(s) are required, Inspur will ship out replacement part(s) in advance within one (1) business day. Customer should return defective part(s) within five (5) business days after receiving the replacement(s). Inspur will cover two-way shipment.



- Customer should return the defective parts in their original packaging to the Inspur designated service center.
 - Inspur will ship out the replacement parts at our own expense after completing remote diagnosis.
 - If Customer needs to designate a logistics company, allocation of the shipping cost to Inspur/Customer will be redefined.
-

9.1.4 9 × 5 × NBD Onsite Service

When Inspur ultimately determines that an onsite service call is required to repair or replace a defect, the call will be scheduled in accordance with the Response Time Commitment. The response time is measured from the time when the remote troubleshooting is completed and logged to the arrival of a service engineer and parts to Customer location for repair.



9 × 5 × NBD: The Inspur service engineer typically arrives at the customer's data center on the next business day. Service engineers are available on local business day from 9:00 am to 6:00 pm local time. Calls received/dispatches after 5:00 pm local time will require an additional day for the service engineer to arrive.

9.1.5 24 × 7 × 4 Onsite Service

When Inspur ultimately determines that an onsite service call is required to repair or replace a defect, the call will be scheduled in accordance with the Response Time Commitment. The response time is measured from the time when the remote troubleshooting is completed and logged to the arrival of a service engineer and parts to Customer location for repair.



NOTE

24 × 7 × 4: The Inspur service engineer typically arrives at the customer site within 4 hours. Service engineers are available at any time, including weekends and local national holidays.

9.2 Inspur Service SLA

Inspur offers a variety of Service Level Agreements (SLA)*² to meet customer requirements.

- RMA Service
- ARMA Service
- 9 × 5 × NBD Onsite Service
- 24 × 7 × 4 Onsite Service

9.3 Warranty Exclusions

Inspur does not guarantee that there will be no interruptions or mistakes during the use of the products. Inspur will not undertake any responsibility for the losses arising from any operation not conducted according to instructions intended for Inspur Hardware Products.

The Limited Warranty does do not apply to

- expendable or consumable parts, such as, but not limited to, batteries or protective coatings that are designed to diminish over time, unless failure has occurred during DOA period due to a defect in material or workmanship;
- any cosmetic damage, such as, but not limited to, scratches, dents, broken plastics, metal corrosion, or mechanical damage, unless failure has occurred during DOA period due to a defect in material or workmanship;
- damage or defects caused by accident, misuse, abuse, contamination, improper or inadequate maintenance or calibration or other external causes;

- damage or defects caused by operation beyond the parameters as stipulated in the user documentation;
- damage or defects by software, interfacing, parts or supplies not provided by Inspur;
- damage or defects by improper storage, usage, or maintenance;
- damage or defects by virus infection;
- loss or damage in transit which is not arranged by Inspur;
- Inspur Hardware Products that have been modified or serviced by non-authorized personnel;
- any damage to or loss of any personal data, programs, or removable storage media;
- the restoration or reinstallation of any data or programs except the software installed by Inspur when the product is manufactured;
- any engineering sample, evaluation unit, or non-mass production product that is not covered under warranty service;
- any solid-state drive (SSD) which has reached its write endurance limit.

In no event will Inspur be liable for any direct loss of use, interruption of business, lost profits, lost data, or indirect, special, incidental or consequential damages of any kind regardless of the form of action, whether in contract, tort (including negligence), strict liability or otherwise, even if Inspur has been advised of the possibility of such damage, and whether or not any remedy provided should fail of its essential purpose.

*1 Service Portal availability is subject to customer type and customer location. Please contact your Inspur representative to learn more.

*2 Not all SLA offerings are available at all customer locations. Some SLA offerings may be limited to geolocation and/or customer type. Please contact your Inspur representative to learn more.

10 System Management

10.1 Intelligent Management System ISBMC

ISBMC, an Inspur self-developed remote server management system, supports mainstream management specifications in the industry such as IPMI 2.0 and Redfish 1.13. ISBMC features high operational reliability, easy serviceability for different business scenarios, accurate and comprehensive fault diagnosis capabilities, and industry-leading security reinforcement capabilities.

ISBMC supports:

- IPMI 2.0
- Redfish 1.13
- SNMP v1/v2c/v3
- HTML5/Java remote consoles (Keyboard, Video, Mouse)
- remote virtual media
- login via web browsers
- intelligent fault diagnosis

Table 10-1 ISBMC Features

Feature	Description
Management Interface	Supports extensive remote management interfaces for various server O&M scenarios. The supported interfaces include: <ul style="list-style-type: none">• IPMI• SSH CLI• SNMP• HTTPS• Web GUI• Redfish• RESTFul• DCMI• Syslog

Feature	Description
Accurate and Intelligent Fault Location	IDL, a self-developed fault diagnosis system, offers accurate and comprehensive hardware fault location capabilities, and outputs detailed fault causes and handling suggestions.
Alert Management	Supports rich automatic remote alert capabilities, including proactive alerting mechanisms such as SNMP Trap (v1/v2/v3), email alerts and syslog remote alerts to ensure 24 × 7 reliability.
Remote Console KVM	Supports HTML5- and Java-based remote console to remotely control and operate the monitor/mouse/keyboard of the server, providing highly available remote management capabilities without on-site operation.
Virtual Network Console (VNC)	Supports mainstream third-party VNC clients without relying on Java, improving management flexibility.
Remote Virtual Media	Supports virtualizing images, USB devices, folders and local media devices as media devices of remote servers, simplifying OS installation, file sharing, and other O&M tasks.
Web GUI	Supports the visual management interface developed by Inspur, displaying abundant information of the server and components, and offers easy-to-use Web GUIs.
Crash Screenshot and Manual Screenshot	<ul style="list-style-type: none"> • Supports automatic crash screenshot with the last screen before crash saved • Provides manual screenshot, which can quickly capture the screen for easy inspection at scheduled time
Dual Flash and Dual Image	Supports dual flash and dual image, enabling automatic flash failover in case of software faults or flash damage, improving operational reliability.
Power Capping	Supports power capping, increasing deployment density and reducing energy consumption.
IPv4/IPv6	Supports both IPv4 and IPv6, enhancing network deployment flexibility.
Auto-Switching of Management Network Port	Supports auto-switching between the dedicated management network port and shared management network port, providing customers with flexible network deployment solutions for different management network deployment scenarios.
ISBMC Self-Diagnosis and Self-Recovery System	<ul style="list-style-type: none"> • Supports the reliable dual watchdog mechanism for hardware and software, enabling automatic restoration of BMC in case of BMC abnormality. • Provides a thermal protection mechanism, which is automatically triggered when the BMC is abnormal to

Feature	Description
	<p>ensure that the fan operates at safe speeds to avoid system overheating.</p> <ul style="list-style-type: none"> • Supports self-diagnosis of processors, memory modules, and storage devices of ISBMC, and automatically cleans the workload to restore to normal when the device usage rate is too high.
Power Supply Control	Supports virtual power buttons for startup, shutdown, restart, and restart after shutdown.
UID LED and Remote Control LED	<ul style="list-style-type: none"> • Supports remote lighting of the UID LED for locating the server in the server room. • Supports remote control LED. The UID LED flashes when a user remotely logs in via web, KVM, or SSH to inform the on-site personnel that an administrator is accessing the server.
Secure Firmware Update	<ul style="list-style-type: none"> • Supports firmware update based on secure digital signatures, and mismatch prevention mechanism for firmware from different manufacturers and firmware for different models. • Supports firmware update of BMC/BIOS/CPLD/PSU.
Serial Port Redirection	Supports remote redirection of the system serial port, BMC serial port and other serial ports, and directs the server-side serial port output to the local administrator via the network for server debugging.
Storage Information Display	Displays RAID logical array information and drive information, and supports remote RAID creation for improved deployment efficiency.
User Role Management	Supports user detail management based on user roles and flexible creation of user roles with different privileges, provides more user roles to allow administrators to grant different privileges to O&M personnel.
Security Features	Adopts the industry-leading Inspur server security baseline standard V2.0. SSH, HTTPS, SNMP use secure and reliable algorithms. ISBMC offers capabilities including secure update and boot and security reinforcement mechanisms such as anti-replay, anti-injection, and anti-brute force.

10.2 Inspur Physical Infrastructure Manager (ISPIM)

The server is compatible with the latest version of Inspur Physical Infrastructure Manager (ISPIM).

The independently developed ISPIM for data centers features asset management, monitoring, inspection, energy consumption management and stateless management. It also provides interfaces such as RESTful and SNMP for easy integration and interfacing. ISPIM has the following key features:

- Lightweight deployment in multiple scenarios and full lifecycle management of devices
- High reliability and on-demand node scalability enabled by 1 to N data collectors
- Intelligent asset management and real-time tracking of asset changes
- Comprehensive monitoring and automatic fault diagnosis
- Batch configuration, deployment and update, shortening the deployment time
- Intelligent analysis and control of power consumption, improving energy conservation efficiency and operation stability of the data center
- Improved version management efficiency
- Standardized northbound interfaces for easy integration and interfacing
- Centralized management of edge devices

Table 10-2 ISPIM Features

Feature	Description
Centralized Device Management	<p>Supports centralized management of network-wide devices, including:</p> <ul style="list-style-type: none">• Servers (the full range of Inspur server family, including general-purpose rack servers, AI servers, blade servers, all-in-one servers and other high-end server products, and third-party servers)• Storage devices (Inspur general-purpose disk arrays, distributed storage devices, and storage devices of other manufacturers)• Network devices (Inspur switches, third-party switches, and third-party firewall devices)

Feature	Description
Monitoring	<ul style="list-style-type: none"> • Centralized display, search, blocking and email notifications of device alerts • Creation of alert rules, notification rules and blocking rules • Alert severity level setting • Alert forwarding and southbound settings • Device performance monitoring • Distributed monitoring
Stateless Computing	<ul style="list-style-type: none"> • BMC/BIOS update and configuration of Inspur servers • RAID configuration of Inspur servers • Firmware configuration templates • Automatic firmware baseline management • Repositories for update files
OS Deployment	<ul style="list-style-type: none"> • Batch deployment of OSs via BMC interfaces • One-click deployment with automatic and detailed logging, and with no manual intervention needed • Concurrent deployment of up to 40 devices
Asset Management	<ul style="list-style-type: none"> • Part-level asset management and multi-dimensional asset report • 3D data centers • Asset maintenance management
Inspection	<ul style="list-style-type: none"> • Active inspection • Alert-triggered passive inspection • Intelligent fault diagnosis and analysis, and call home.
Power Consumption Management	<ul style="list-style-type: none"> • Multi-dimensional report of power consumption • Intelligent power capping strategies • A variety of power consumption optimization analyses, including cooling analysis, server utilization analysis, server power consumption analysis, and load

Feature	Description
	distribution analysis. Intelligent power consumption prediction
Security Management	Implements security control of ISPIM via a set of security policies such as user management, role management, authentication management (local authentication and LDAP authentication) and certificate management.

10.3 Inspur Server Intelligent Boot (ISIB)

The server is compatible with the latest version of Inspur Server Intelligent Boot (ISIB) system, a self-developed automatic O&M management system throughout the server lifecycle. Based on the SSH and PXE technologies, it is compatible with the full range of Inspur servers, and offers more efficient and reliable automatic deployment and software and hardware configuration management. ISIB has the following key features:

- Full lifecycle management from deployment to automatic O&M
- One-stop and one-click deployment for bare metal servers
- Flexible task scheduling with O&M capabilities in multiple scenarios
- Large-scale deployment of technical architecture, shortening the deployment time
- Zero network deployment with plug-and-play support
- Accurate logging and instruction-level tracing of execution results
- Rich built-in O&M scripts and management schemes

Table 10-3 ISIB Features

Feature	Description
Home	<ul style="list-style-type: none"> • Provides multi-dimensional reports of assets, repositories, operations and jobs. • Displays jobs 24 hours dynamically • Displays column bars of jobs in the last 30 days
Asset	Supports automatic device discovery, OS information collection, and out-of-band/in-band power supply management.

Feature	Description
Repository	Enables you to manage images, software, firmware, configuration files, scripts and sources for easy OS deployment and firmware update.
Operation	<ul style="list-style-type: none"> • Firmware update • Hardware configuration • Automatic OS installation via PXE • Installation template management • Image cloning and restoration • Software distribution • Configuration changes • System inspection
Task	<ul style="list-style-type: none"> • Supports job scheduling, and scheduled and periodic task execution • Provides visual multi-dimensional task display and detailed logging
GShell	Remote management of a single SSH terminal or multiple SSH terminals
DFX	<ul style="list-style-type: none"> • Supports HA high availability and secure access via HTTPS • Supports system snapshots and self-service management • Supports batch O&M at a scale of 10,000 devices • Provides the northbound RESTful interfaces

11 Certifications

Table 11-1 Certifications

Country/Region	Certification	Mandatory/Voluntary
China	CCC	Mandatory
	CECP	Voluntary
	China Environmental Labelling	Voluntary
International Mutual Recognition	CB	Voluntary
EU	CE	Mandatory
US	FCC	Mandatory
	UL	Voluntary
	Energy Star	Voluntary
UK	CE	Mandatory
Russia	EAC	Mandatory
	FSS	Mandatory
India	BIS	Mandatory
South Korea	E-Standby	Mandatory
	KC	Mandatory
Australia	RCM	Mandatory
Taiwan, China	BSMI	Mandatory
Israel	SII	Mandatory
Mexico	NOM	Mandatory
Egypt	NTRA	Voluntary
Saudi Arabia	SABER	Mandatory
Canada	IC	Mandatory

12 Appendix A

12.1 Operating Temperature Specification Limits

Table 12-1 Operating Temperature Specification Limits

Configurat ion	Max. Operating Temp. 30°C (86°F)	Max. Operating Temp. 35°C (95°F)	Max. Operating Temp. 40°C (104°F)	Max. Operating Temp. 45°C (113°F)
12 × 3.5- inch Drive Configurati on, chassis perforated	<ul style="list-style-type: none"> • 6056 fans • RDIMMs ≤32 pcs • CPUs ≤350 W • 8 PCIe cards (100 Gb OCP cards not supported) • GPUs not supported 	<ul style="list-style-type: none"> • 6056 fans • RDIMMs ≤32 pcs • CPUs ≤350 W • 8 PCIe cards (100 Gb OCP cards not supported) • GPUs not supported 	Not supported	Not supported
8 × 3.5- inch Drive Configurati on, chassis perforated	<ul style="list-style-type: none"> • 6056 fans • RDIMMs ≤32 pcs • CPUs ≤270 W • 8 PCIe cards (100 Gb OCP cards not supported) • GPUs supported 	<ul style="list-style-type: none"> • 6056 fans • RDIMMs ≤32 pcs • CPUs ≤270 W • 8 PCIe cards (100 Gb OCP cards not supported) • GPUs supported 	Not supported	Not supported
12 × 3.5- inch Drive	<ul style="list-style-type: none"> • 6056 fans 	<ul style="list-style-type: none"> • 6056 fans 	Not supported	Not supported

Configurat ion	Max. Operating Temp. 30°C (86°F)	Max. Operating Temp. 35°C (95°F)	Max. Operating Temp. 40°C (104°F)	Max. Operating Temp. 45°C (113°F)
Configurati on, chassis perforated	<ul style="list-style-type: none"> • RDIMMs ≤32 pcs • CPUs ≤270 W • 8 PCIe cards • GPUs not supported • Internal drives supported 	<ul style="list-style-type: none"> • RDIMMs ≤32 pcs • CPUs ≤270 W • 8 PCIe cards • GPUs not supported • Internal drives supported 		
8 × 3.5- inch Drive Configurati on, chassis perforated	<ul style="list-style-type: none"> • 6038 fans • RDIMMs ≤32 pcs • CPUs ≤270 W • 8 PCIe cards • GPUs not supported 	<ul style="list-style-type: none"> • 6038 fans • RDIMMs ≤32 pcs • CPUs ≤270 W • 8 PCIe cards • GPUs not supported 	Not supported	Not supported
24 × 2.5- inch Drive Configurati on, chassis perforated	<ul style="list-style-type: none"> • 6056 fans • RDIMMs ≤32 pcs • CPUs ≤350 W • 8 PCIe cards (100 Gb OCP cards not supported) • GPUs not supported 	<ul style="list-style-type: none"> • 6056 fans • RDIMMs ≤32 pcs • CPUs ≤350 W • 8 PCIe cards (100 Gb OCP cards not supported) • GPUs not supported 	Not supported	Not supported
8 × 2.5- inch Drive Configurati	<ul style="list-style-type: none"> • 6056 fans 	<ul style="list-style-type: none"> • 6056 fans 	Not supported	Not supported

Configurat ion	Max. Operating Temp. 30°C (86°F)	Max. Operating Temp. 35°C (95°F)	Max. Operating Temp. 40°C (104°F)	Max. Operating Temp. 45°C (113°F)
on, chassis perforated	<ul style="list-style-type: none"> • RDIMMs ≤32 pcs • CPUs ≤270 W • 8 PCIe cards (100 Gb OCP cards not supported) • GPUs supported 	<ul style="list-style-type: none"> • RDIMMs ≤32 pcs • CPUs ≤270 W • 8 PCIe cards (100 Gb OCP cards not supported) • GPUs supported 		
Extreme temp config, 8 x 2.5-inch NVMe/SAS /SATA Drive	<ul style="list-style-type: none"> • 6056 fans • RDIMMs ≤32 pcs • CPUs ≤235 W • 8 PCIe cards • OCP cards not supported • GPUs not supported 	<ul style="list-style-type: none"> • 6056 fans • RDIMMs ≤32 pcs • CPUs ≤235 W • 8 PCIe cards • OCP cards not supported • GPUs not supported 	<ul style="list-style-type: none"> • 6056 fans • RDIMMs ≤32 pcs • CPUs ≤235 W • 8 PCIe cards • OCP cards not supported • GPUs not supported 	Not supported

 NOTE

- The maximum operating temperature is 5°C (9°F) lower than the rated value if a single fan fails.

12.2 Model

Table 12-2 Model

Certified Model	Description
NF5280-M7-A0-R0-00	Global

12.3 RAS Features

The server supports a variety of RAS (Reliability, Availability, and Serviceability) features. By configuring these features, the NF5280G7 can provide greater reliability, availability and serviceability.

12.4 Sensor List

Table 12-3 Sensor List

Sensor	Description	Sensor Location
Inlet_Temp	Air inlet temperature	Right mounting ear
Outlet_Temp	Air outlet temperature	DC-SCM board
PVCCIN_CPUX	CPUX core voltage	CPUX x indicates the CPU number with a value of 0 - 1
PVCCFA_FIVR_CPUX	UPI IIO voltage	CPUX x indicates the CPU number with a value of 0 - 1
PVCCINFAON_CPUX	CPUX boot voltage	CPUX x indicates the CPU number with a value of 0 - 1
PVCCFA_EHV_CPUX	Controller voltage	CPUX x indicates the CPU number with a value of 0 - 1
PVCCD_HV_CPUX	Memory controller voltage	CPUX x indicates the CPU number with a value of 0 - 1
CPUX_VR_Temp	CPUX VR temperature	CPUX x indicates the CPU number with a value of 0 - 1
PSUX_VIN	PSUX input voltage	PSUX x indicates the PSU number with a value of 0 - 1
PSUX_VOUT	PSUX output voltage	PSUX

Sensor	Description	Sensor Location
		x indicates the PSU number with a value of 0 - 1
SYS_12V	System 12 V voltage (output by HSC)	Motherboard
SYS_5V	System 5 V voltage	Motherboard
SYS_3V3	System 3.3 V voltage	Motherboard
RTC_Battery	RTC battery voltage on motherboard	Motherboard
PVNN_MAIN_CPUX	CPUx voltage	Motherboard
P12V_CPUX_DIMM	CPUx DIMM temperature	Motherboard
PVNN_PCH_STBY	PCH core voltage	Motherboard
P1V05_PCH_STBY	PCH logic voltage	Motherboard
CPUX_Temp	CPUx core temperature	CPUx x indicates the CPU number with a value of 0 - 1
CPUX_DTS	CPUx DTS temperature CPU margin temperature before it reaches the throttling frequency	CPUx x indicates the CPU number with a value of 0 - 1
CPUX_DIMM_T	The maximum temperature among DDR5 DIMMs of CPUx	CPUx x indicates the CPU number with a value of 0 - 1
PCH_Temp	PCH temperature	Motherboard
PSU_Inlet_Temp	PSU temperature	PSU
Total_Power	Total power	Motherboard
FAN_Power	Total fan power	Fans
PSUX_PIN	PSUx input power	PSUx x indicates the PSU number with a value of 0 - 1
PSUX_POUT	PSUx output power	PSUx x indicates the PSU number with a value of 0 - 1
CPU_Power	Total CPU power	Motherboard
Memory_Power	Total memory power	Motherboard
FANX_F_Speed, FANX_R_Speed	FANx speed	FANx x indicates the fan number with a value of 0 - 5
RAID_Temp	Non-mezz RAID controller card temperature (Max temp. will be taken in case of multiple RAID controller cards,	RAID controller cards

Sensor	Description	Sensor Location
	including SAS, RAID, and HBA)	
HDD_MAX_Temp	Maximum temperature among all drives	/
OCP_RAID_Temp	Mezz RAID controller card temperature	Mezz RAID controller card
NVME_Temp	Maximum temperature among all NVMe drives	Drives
OCP_NIC_SFP_Temp	OCP NIC SFP temperature	Optical module
PCIe_NIC_SFP_T	PCIe NIC SFP temperature	Optical module
OCP_NIC_Temp	OCP NIC temperature (Max temp. will be taken in case of multiple OCP NICs)	OCP NICs
PCIe_NIC_Temp	PCIe NIC temperature (Max temp. will be taken in case of multiple PCIe NICs)	PCIe NICs
MEM_Resource Rate	Memory utilization rate	DIMMs
CPU_Resource Rate	CPU utilization rate	CPU
GPUX_Temp	GPUx core temperature	GPU
CPUX_Status	CPUX status	CPUX x indicates the CPU number with a value of 0 - 1
SEL_Status	SEL status	/
PSU_Mismatch	PSU models mismatch	/
PSU_Redundant	PSU redundancy status	/
FANn_Status	FANn status	FANn n indicates the fan number with a value of 0 - 5
FAN_Redundant	Fan redundancy status	/
PCIe_Status	PCIe failure status, including PCIe bus, slots and cards	/
POST_Status	System firmware and POST status	/
PWR_CAP_Fail	Power capping failure	/
CPUN1_CN2DN3	DIMM silkscreen	N1 indicates the CPU number, with a value of 0 - 1 N2 indicates the channel number, with a value of 0 - 7

Sensor	Description	Sensor Location
		N3 indicates the DIMM slot number, with a value of 0 - 1
CPU_Config	CPU configuration status (mixing of CPUs, or primary CPU not installed)	/
PSUN_Status	PSUn status	PSUn n indicates the PSU number with a value of 0 - 1
K_HDDX	HDDx	HDDx <ul style="list-style-type: none"> • K denotes front, internal, and rear drives, with a value of F/I/R respectively • X indicates the drive number
ACPI_PWR	ACPI power status	/
Sys_Health	System health status	/
BMC_Boot_Up	BMC boot up complete	/
BIOS_Boot_Up	BIOS boot up complete	/
Intrusion	Chassis-opening activity	Top cover
LeakageSensor	Leak detection	Leak detection cable
ME_FW_Status	ME health status	ME
TPM_Verify	TPM verification status	/

13 Appendix B Acronyms and Abbreviations

13.1 A - E

A

AC	Alternating Current
ACPI	Advanced Configuration and Power Interface
AD	App Direct
AI	Artificial Intelligence
AQSIQ	General Administration of Quality Supervision, Inspection and Quarantine of the People's Republic of China
AVX	Advanced Vector Extensions

B

BIOS	Basic Input Output System
BIS	Bureau of Indian Standards
BLE	BIOS Lock Enable
BMC	Baseboard Management Controller
BPS	Barlow Pass
BSMI	The Bureau of Standards, Metrology and Inspection

C

CAS	Column Address Strobe
-----	-----------------------

CB	Certification Body
CCC	China Compulsory Certificate
CE	Conformité Européenne
CECP	China Energy Conservation Program
CEN	European Committee for Standardization
CLI	Command-Line Interface
CLK	Clock
CMOS	Complementary Metal-Oxide-Semiconductor
CPLD	Complex Programmable Logic Device
CPU	Central Processing Unit
CRPS	Common Redundant Power Supply

D

DC	Direct Current
DCMI	Data Center Manageability Interface
DDR5	Double Data Rate 5
DIMM	Dual In-line Memory Module
DL	Deep Learning
DPC	DIMM Per Channel
DRAM	Dynamic Random Access Memory
DTS	Digital Thermal Sensor

E

EAC	Eurasian Conformity
ECC	Error-Correcting Code
ECMA	European Computer Manufacturers Association

EMR	Emerald Rapids
ESD	Electrostatic Discharge
E1.S	Enterprise & Data Center SSD Form Factor 1 Unit Short

13.2 F - J

F

FCC	Federal Communications Commission
FHFL	Full-Height Full-Length
FHHL	Full-Height Half-Length
FSS	Federal Security Service
FW	Firmware

G

GbE	Gigabit Ethernet
GPU	Graphics Processing Unit
GUI	Graphical User Interface

H

HBA	Host Bus Adapter
HCA	Host Channel Adapter
HDD	Hard Disk Drive
HHHL	Half-Height Half-Length
HSE	Health and Safety Executive
HTML	HyperText Markup Language
HTTPS	Hypertext Transfer Protocol Secure

I

I/O	Input/Output
IC	Industry Canada
IDL	Inspur Diagnosis Log
IEC	International Electrotechnical Commission
IIPC	Intel Intelligent Power Capability
IMC	Integrated Memory Controller
IOPS	Input/Output Operations Per Second
IP	Internet Protocol
IPMI	Intelligent Platform Management Interface
IPV4	Internet Protocol version 4
IPv6	Internet Protocol version 6
ISBMC	Inspur Server Baseboard Management Controller
ISIB	Inspur Server Intelligent Boot
ISO	International Organization for Standardization
ISPIM	Inspur Physical Infrastructure Manager
ISQP	Inspur Server Quick Provisioning

J

JTAG	Joint Test Action Group
------	-------------------------

13.3 K - O

K

KC	Korea Certification
KVM	Keyboard Video Monitor

L

LAN	Local Area Network
LCD	Liquid Crystal Display
LDAP	Lightweight Directory Access Protocol
LED	Light Emitting Diode
LOA	Letter of Authority
LRDIMM	Load-Reduced Dual In-line Memory Module

M

ME	Management Engine
MM	Memory Mode

N

NC-SI	Network Controller Sideband Interface
NIC	Network Interface Card
NIOSH	National Institute for Occupational Safety and Health
NOM	Norma Oficial Mexicana
NUMA	Non-Uniform Memory Access
NVMe	Non-Volatile Memory Express

O

OCP	Open Compute Project
OS	Operating System

13.4 P - T

P

PCH	Platform Controller Hub
PCIe	Peripheral Component Interconnect Express
PDU	Power Distribution Unit
PID	Proportional-Integral-Derivative
PMem	Persistent Memory
POST	Power-On Self-Test
PSU	Power Supply Unit
PXE	Pre-boot Execution Environment

R

RAID	Redundant Arrays of Independent Disks
RAS	Reliability, Availability, Serviceability
RCM	Regulatory Compliance Mark
RDIMM	Registered Dual In-line Memory Module
RH	Relative Humidity
RHEL	Red Hat Enterprise Linux
RJ45	Registered Jack 45
RST	Reset
RTC	Real Time Clock

S

SABS	South African Bureau of Standards
SAS	Serial Attached SCSI
SATA	Serial Advanced Technology Attachment

SCSI	Small Computer System Interface
SEL	System Event Log
SFP	Small Form-Factor Pluggable
SGPIO	Serial General Purpose Input/Output
SGX	Software Guard Extensions
SII	The Standards Institution of Israel
SN	Serial Number
SNMP	Simple Network Management Protocol
SPR	Sapphire Rapids
SSD	Solid State Drive
SSH	Secure Shell
Syslog	System Log

T

TCM	Trusted Cryptography Module
TDP	Thermal Design Power
TF	TransFlash
TME	Total Memory Encryption
TPM	Trusted Platform Module

13.5 U - Z

U

UEFI	Unified Extensible Firmware Interface
UID	Unit Identification
UKCA	UK Conformity Assessed

UL	Underwriters Laboratories
UPI	Ultra Path Interconnect
USB	Universal Serial Bus

V

VGA	Video Graphics Array
VLAN	Virtual Local Area Network
VMD	Volume Management Device
VNC	Virtual Network Console
VNNI	Vector Neural Network Instructions
VPP	Virtual Pin Port
VRD	Voltage Regulator-Down
VROC	Virtual RAID on CPU