



# Inspur Server NF5280M6 White Paper

Version V1.0  
Date 2021/09/19

Copyright ©2021 Inspur Electronic Information Industry Co., Ltd. All rights reserved.  
No part of this document may be reproduced, modified or transmitted in any form or by any means without prior written consent of Inspur.

## Trademark Notice

Inspur and Inspur Logo are registered trademarks of Inspur Group.  
Windows is a registered trademark of Microsoft Corporation.  
Intel and Xeon are registered trademarks of Intel Corporation.  
All other trademarks mentioned in this document are the property of their respective holders.

## Disclaimer

The purchased products, services and features shall be bound by the contract made between Inspur and the customer. All or part of the products, services and features described herein may not be within your purchase or usage scope. Unless otherwise agreed in the contract, Inspur Group makes no representations or warranties, express or implied, regarding the contents of this document. The content of this document may be updated from time to time due to product version upgrades or other reasons. Unless otherwise agreed, this document is intended as a guide for use only, and all statements, information and recommendations in this document do not constitute any express or implied warranties.

Some products, services, and features can be implemented only when specific conditions (such as configuration, limitation, and temperature) are satisfied, as described in Section 6 of this document. Inspur has no liability for any is-sues arising therefrom.

## Technical Support

Technical Service Hotline: 1-844-860-0011/1-760-769-1847

Address: No. 1036, Langchao Road, Jinan, Shandong Province, China



Inspur Electronic Information Industry Co., Ltd.



Email: serversupport@inspur.com

Postal Code: 250101

## Symbol Conventions

The symbols that may be found in this document are defined as follows.

| Symbol  | Description   |
|---|---|
|  DANGER  | A potential for serious injury, or even death if not properly handled   |
|  WARNING | A potential for minor or moderate injury if not properly handled        |
|  CAUTION | A potential loss of data or damage to equipment if not properly handled |

| Symbol  | Description  |
|---|--|
|  IMPORTANT | Operations or information that requires special attention to ensure successful installation or configuration |
|  NOTE      | Supplementary description of important information   |

## Revision History

| Version | Date       | Description of Changes                              |
|---------|------------|---|
| V0.95   | 2021/04/15 | Initial release                                     |
| V1.00   | 2021/09/19 | Optimize the safety description of product features |

## Contents

|       |   |    |
|-------|---|----|
| 1     | Product Overview .....                            | 1  |
| 2     | Features .....                                    | 2  |
| 3     | New Technical Highlights.....                     | 4  |
| 3.1   | Intel® Scalable Architecture.....                 | 4  |
| 3.2   | Intel® VROC .....                                 | 4  |
| 3.3   | OCP NIC 3.0 Module .....                          | 4  |
| 3.4   | Intel® Optane™ Persistent Memory 200 Series ..... | 4  |
| 3.5   | BFloat16 Better Empowering AI.....                | 4  |
| 4     | Logical Architecture.....                         | 6  |
| 5     | Product Overview .....                            | 7  |
| 5.1   | Front Panel.....                                  | 7  |
| 5.1.1 | 12 × 3.5"/2.5" Front Panel.....                   | 7  |
| 5.1.2 | 24 × 2.5" Front Panel.....                        | 8  |
| 5.1.3 | 25 × 2.5" Front Panel.....                        | 9  |
| 5.1.4 | 2.5/3.5-inch Drive Tray LEDs .....                | 10 |
| 5.2   | Rear Panel.....                                   | 11 |
| 5.2.1 | Drive Rear Panel .....                            | 11 |
| 5.3   | Internal Top View.....                            | 12 |
| 5.4   | OCP NIC 3.0 Module .....                          | 12 |
| 5.5   | M.2.....  | 13 |
| 5.6   | E1.S.....   | 14 |
| 5.7   | Mainboard Layout.....                             | 14 |
| 6     | System Specifications.....                        | 17 |
| 7     | Compatibility List.....                           | 23 |
| 7.1   | Processor .....                                   | 23 |
| 7.2   | Memory .....                                      | 24 |
| 7.3   | Storage.....                                      | 25 |
| 7.3.1 | SATA/SAS Drive Models .....                       | 25 |
| 7.3.2 | SSD Models.....                                   | 26 |
| 7.3.3 | U.2 NVMe SSDs .....                               | 27 |
| 7.4   | Drive Backplane.....                              | 27 |
| 7.5   | Drive Installation Position .....                 | 29 |
| 7.5.1 | HDD Installation Sequence .....                   | 29 |
| 7.5.2 | NVMe Drive Installation Position .....            | 29 |

---

|      |   |    |
|------|---|----|
| 7.6  | RAID/SAS Card.....                                  | 31 |
| 7.7  | NIC.....  | 32 |
| 7.8  | FC HBA Card.....                                    | 32 |
| 7.9  | HCA Card.....                                       | 33 |
| 7.10 | Graphic Card & GPU.....                             | 33 |
| 7.11 | Power Supply.....                                   | 33 |
| 7.12 | Operating System.....                               | 34 |
| 8    | Configuration Notes.....                            | 35 |
| 9    | System Management.....                              | 36 |
| 9.1  | Intelligent Management System ISBMC.....            | 36 |
| 9.2  | Inspur Physical Infrastructure Manager (ISPIM)..... | 38 |
| 9.3  | Inspur Server Intelligent Boot (ISIB).....          | 39 |
| 10   | Certification.....                                  | 41 |
| 11   | Service Terms.....                                  | 42 |
| 12   | Relevant Documents.....                             | 43 |
| 13   | Trademark.....                                      | 44 |

# 1 Product Overview

---

Inspur NF5280M6 is a 2U 2-socket rack server engineered for Internet, Internet Data Center (IDC), cloud computing, enterprise markets and telecommunications applications. It delivers superior performance, reliability, scalability, and manageability and is applicable to various business scenarios with complex workloads. It meets customer requirements for high network bandwidth, high computing performance, and large memory capacity and is also a perfect solution for customers with density and storage demands.

# 2 Features

NF5280M6 maintains high quality and reliability of Inspur servers for different applications. It adopts ultimate design philosophy in performance, scalability, availability and manageability and offers multiple configurations, meeting demands in all industries.

- **Performance:**

- NF5280M6 is built on the 3rd generation Intel® Xeon® Scalable processors. Each CPU communicates with each other via 3 UPI links at 11.2GT/s. A single CPU supports up to 40 cores (1.5MB L3 cache per core) and 80 threads with a max turbo frequency of 3.6GHz and TDP at up to 270W, enabling powerful parallel processing capabilities.
- 32 DDR4 ECC memory modules (3200MT/s, RDIMMs and LRDIMMs), offering a maximum capacity of 4T (under dual-CPU configuration) to deliver high speeds and superior availability.
- 3200MHz Intel® Optane™ Persistent Memory (PMEM) with a maximum capacity of 512GB, ensuring memory data integrity in case of powering off without reducing memory capacity and bandwidth.
- An all-flash configuration of up to 28 hot-swap NVMe SSDs, providing a high IOPS ten times better than that of high-end enterprise-level SATA SSDs, bringing a great increase in storage performance.

- **Scalability:**

- Up to 25 front 2.5-inch drives, 4 internal 3.5-inch drives and 10 rear 2.5-inch drives.
- Optional OCP NIC 3.0 module with multiple network port options (1/10/25/100/200 GB), offering a more flexible network architecture for different applications.
- One OCP 3.0 slot, one RAID card slot, up to 4 PCIe 4.0 x16 slots and up to 11 standard PCIe expansion slots.
- Optional rear M.2 or E1.S modules for diverse storage demands.

- **Availability:**

- With a user-friendly design, the entire system supports tool-free maintenance. With enhanced structural parts, NF5280M6 allows easy assembly/disassembly, greatly reducing the O&M time.
- Inspur's unique intelligent control technology together with cutting-edge air cooling system enables optimum working environment to ensure stable running of the server.
- Hot-swap drives can be configured to RAID level 0/1/1E/10/5/50/6/60, with RAID cache and power failure protection enabled by super capacitor module.
- With the latest BMC technology, technicians can quickly locate the component that has failed (or is failing) via the UID LED on the front panel, through the Web GUI, fault diagnosis LEDs, simplifying maintenance, speeding up troubleshooting and enhancing system availability.
- With BMC, technicians can monitor system parameters, get alarms in a timely manner and take proper actions accordingly to ensure stable running of the system and minimize system downtime.

- **Manageability**

- ISBMC, a remote server management system developed in house, is equipped on the server.

- ISBMC supports such mainstream management specifications in the industry as IPMI 2.0 and Redfish 1.8.
- ISBMC delivers higher operational reliability.
- ISBMC features excellent serviceability for different customer scenarios.
- ISBMC provides comprehensive and accurate fault diagnosis capabilities.
- ISBMC offers enhanced security above industry average.

- **Energy Efficiency**

- 80 PLUS Platinum PSU (550W - 2000W) with the power efficiency up to 94% at a load of 50%.
- Integrated AC/DC power supply for higher power conversion efficiency.
- Efficient voltage regulator-down (VRD) PSU on the mainboard to reduce the loss of DC-DC conversion.
- Intelligent speed control of fans and intelligent frequency modulation of CPUs for energy conservation.
- Optimized cooling design in an all-round way, including energy-efficient cooling fans and ultra-low heat dissipation pressure due to low system energy consumption.

- **Security**

- Intel® Platform Firmware Resilience (PFR) is supported.
- Trusted Platform Module (TPM 2.0) and Trusted Cryptography Module (TCM) provide advanced encryption functions.
- A digital signature validation mechanism is available, where the digital signature is validated in case of firmware update, so as to avoid unauthorized firmware updates.
- Intel® Trusted Execution Technology provides hardware-based protection against malware attacks.
- Intel® Software Guard Extensions (SGX) allows applications to run in independent spaces, preventing theft and unauthorized change of critical codes and data.
- The firmware update mechanism based on digital signatures prevents unauthorized firmware updates.
- UEFI Secure Boot protects the system from malicious bootloaders.
- Hierarchical BIOS password protection ensures the security of system boot and management.
- BIOS Secure Flash and BIOS Lock Enable (BLE) reduce attacks from malicious software on BIOS Flash regions.
- Dual mirroring of BMC and BIOS ensures recovery of firmware when any firmware damage is detected.
- BMC Secure Boot protects BMC from malicious tampering.
- Flexible BMC access control policies improve BMC management security.
- Chassis intrusion detection enhances physical security.



# 3 New Technical Highlights

---

## 3.1 Intel® Scalable Architecture

NF5280M6 features the 3<sup>rd</sup> generation Intel® Xeon® Scalable processors, where the chipset uses the Mesh interconnection design instead of the traditional Ring design to reduce CPU access latency and provide higher memory bandwidth. Besides, with low power consumption, the processors automatically reduce operating frequency in case of low system load and can work at a relatively low voltage, so as to improve performance and energy efficiency.

## 3.2 Intel® VROC

Intel® Virtual RAID on CPU (VROC) is specially designed for enterprise-level RAID solutions based on NVMe SSDs. Its biggest advantage lies in direct management of NVMe SSDs connected to PCIe channels of Intel® Xeon® Scalable processors, without the need for a dedicated RAID controller.

## 3.3 OCP NIC 3.0 Module

The optional OCP NIC 3.0 module (up to 200 GB) provides larger scalability.

## 3.4 Intel® Optane™ Persistent Memory 200 Series

The Intel® Optane™ Persistent Memory 200 series (Barlow Pass), a new type of non-volatile memory module, enables persistent memory data storage even in case of power outage. In comparison with traditional NVDIMMs, super-capacitor modules are not needed, making it easy to integrate the memory module into the system. The latest generation of Optane™ DC Persistent Memory offers a speed of up to 3200 MT/s. It delivers an increase of up to 25% higher memory bandwidth than the previous generation (AEP). The power consumption is reduced to 15 W from the 18 W in the previous generation. Hence, more power consumption can be saved when a large number of Optane™ DC Persistent Memory modules are used.

## 3.5 BFloat16 Better Empowering AI

The 3<sup>rd</sup> generation Intel® Xeon® Scalable processors supports 16-bit Brain Floating Point (BFloat16) format, which enhances the efficiency of developing and executing AI and analytics workloads in various environments such as data centers, network, and intelligent edge computing. As the industry's first mainstream processor with BFloat16 built in, the 3<sup>rd</sup> generation Intel® Xeon® Scalable family make AI training and heterogeneous acceleration more widely deployable on general-purpose servers for applications in image classification, recommendation engine, automatic speech recognition (ASR), and natural language processing (NLP) modelling.

In most neural network computing, BFloat16 offers the same accuracy as FP32, but uses only half of the bits FP32 uses, reducing the memory usage by half and doubling the data throughput. In addition, BFloat16 is integrated in the Intel DL Boost feature by Intel. With support for deep learning architectures such as TensorFlow and PyTorch as well as optimization for OpenVINO toolkit and ONNX execution environment, BFloat16 can achieve the same model accuracy via only slight software adjustment. What's more, it can improve AI training and inference efficiency of the processors.

# 4 Logical Architecture

NF5280M6 features two Intel® Xeon® Scalable processors built on the Ice Lake architecture and supports up to 32 DDR4 DIMMs. Data can be transferred between the two processors through 3 UPI buses at a maximum speed of 11.2GT/s. The processors are connected to the mainboard through the PCIe bus. One OCP 3.0 slot, one RAID card slot, up to 4 onboard PCIe 4.0 x16 slots and up to 11 standard PCIe expansion slots are supported. The onboard RAID card is connected to CPU0 via the PCIe bus and to the drive backplanes via SAS signal cables. The different drive backplanes enable various local storage configurations. The following figure 4-1 illustrates the logic block diagram of NF5280M6.

**Figure 4-1 Logic Block Diagram of NF5280M6**

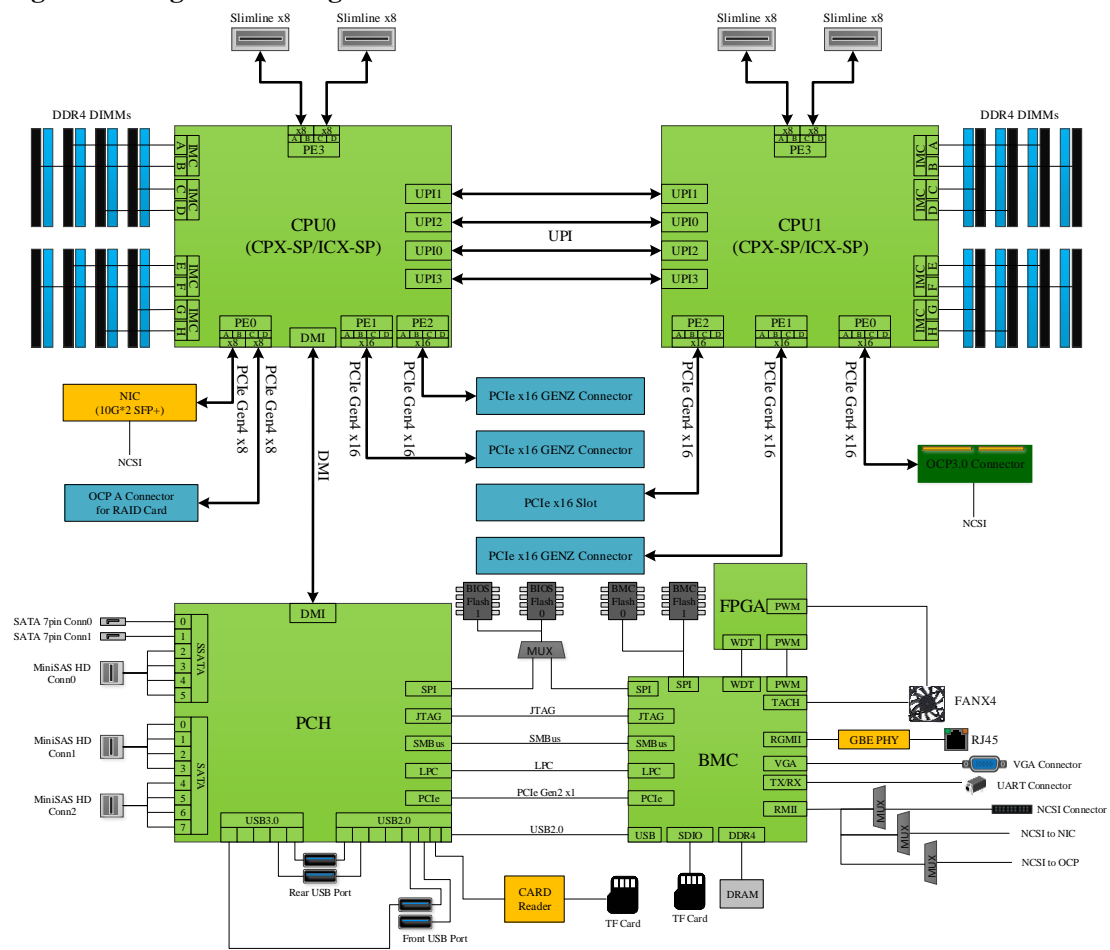

# 5 Product Overview

## 5.1 Front Panel

### 5.1.1 12 × 3.5"/2.5" Front Panel

Figure 5-1 Front View

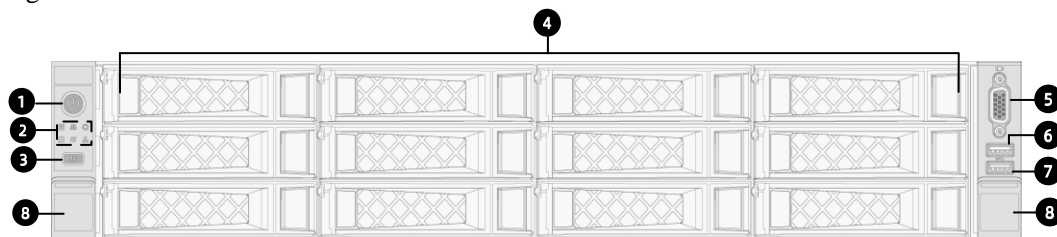

| # | Item                   |
|---|------------------------|
| 1 | Power Button           |
| 2 | LEDs                   |
| 3 | UID/BMC RST Button     |
| 4 | Drive Modules (12-bay) |
| 5 | VGA Port               |
| 6 | USB 3.0 Port           |
| 7 | USB 2.0/LCD Port       |
| 8 | Quick Release Lever    |

Figure 5-2 LEDs and Buttons on the Left Mounting Ear

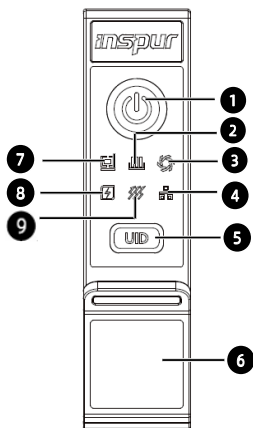

| # | Item                | # | Item                |
|---|---------------------|---|---------------------|
| 1 | Power Button        | 6 | Quick Release Lever |
| 2 | Memory Status LED   | 7 | System Status LED   |
| 3 | Fan Status LED      | 8 | Power Status LED    |
| 4 | Network Status LED  | 9 | System Overheat LED |
| 5 | UID Button with LED |   |                     |

Figure 5-3 Ports on the Right Mounting Ear

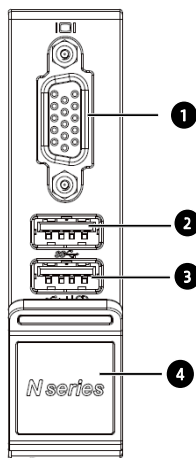

| # | Item         | # | Item                |
|---|--------------|---|---------------------|
| 1 | VGA Port     | 3 | USB 2.0/LCD Port    |
| 2 | USB 3.0 Port | 4 | Quick Release Lever |

### 5.1.2 24 × 2.5" Front Panel

Figure 5-4 Front View

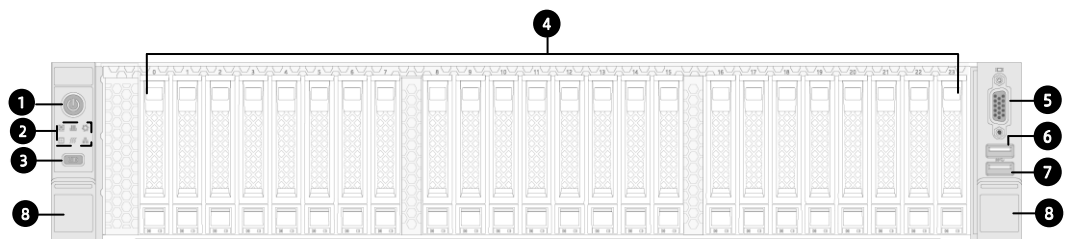

| # | Item                   |
|---|------------------------|
| 1 | Power Button           |
| 2 | LEDs                   |
| 3 | UID/BMC RST Button     |
| 4 | Drive Modules (24-bay) |
| 5 | VGA Port               |
| 6 | USB 3.0 Port           |
| 7 | USB 2.0/LCD Port       |
| 8 | Quick Release Lever    |

### 5.1.3 25 × 2.5" Front Panel

Figure 5-5 Front View

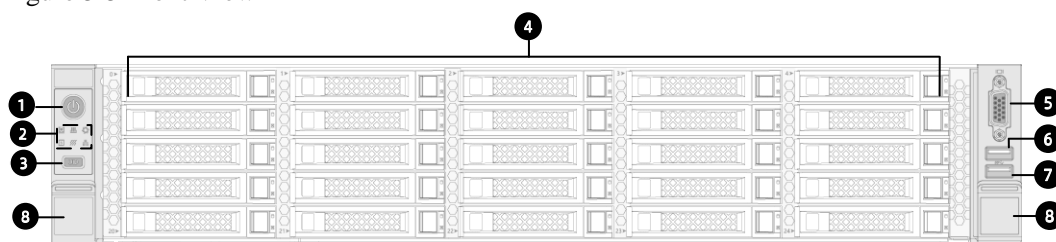

| # | Item                   |
|---|------------------------|
| 1 | Power Button           |
| 2 | LEDs                   |
| 3 | UID/BMC RST Button     |
| 4 | Drive Modules (25-bay) |
| 5 | VGA Port               |

| # | Item                |
|---|---------------------|
| 6 | USB 3.0 Port        |
| 7 | USB 2.0/LCD Port    |
| 8 | Quick Release Lever |

### 5.1.4 2.5/3.5-inch Drive Tray LEDs

Figure 5-6 Drive Tray LEDs

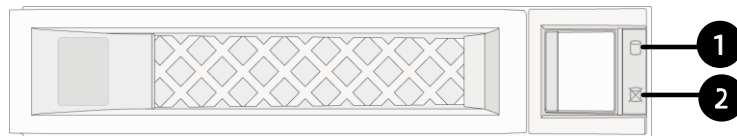

| # | Item                | Description  |
|---|---------------------|--|
| 1 | Activity Status LED | Solid green = Normal<br>Flashing green = Read/write activities   |
| 2 | Drive Fault LED     | Solid red = Drive error or failed<br>Solid blue = Drive is being located<br>Solid pink = RAID rebuilding |

## 5.2 Rear Panel

### 5.2.1 Drive Rear Panel

Figure 5-7 Front View

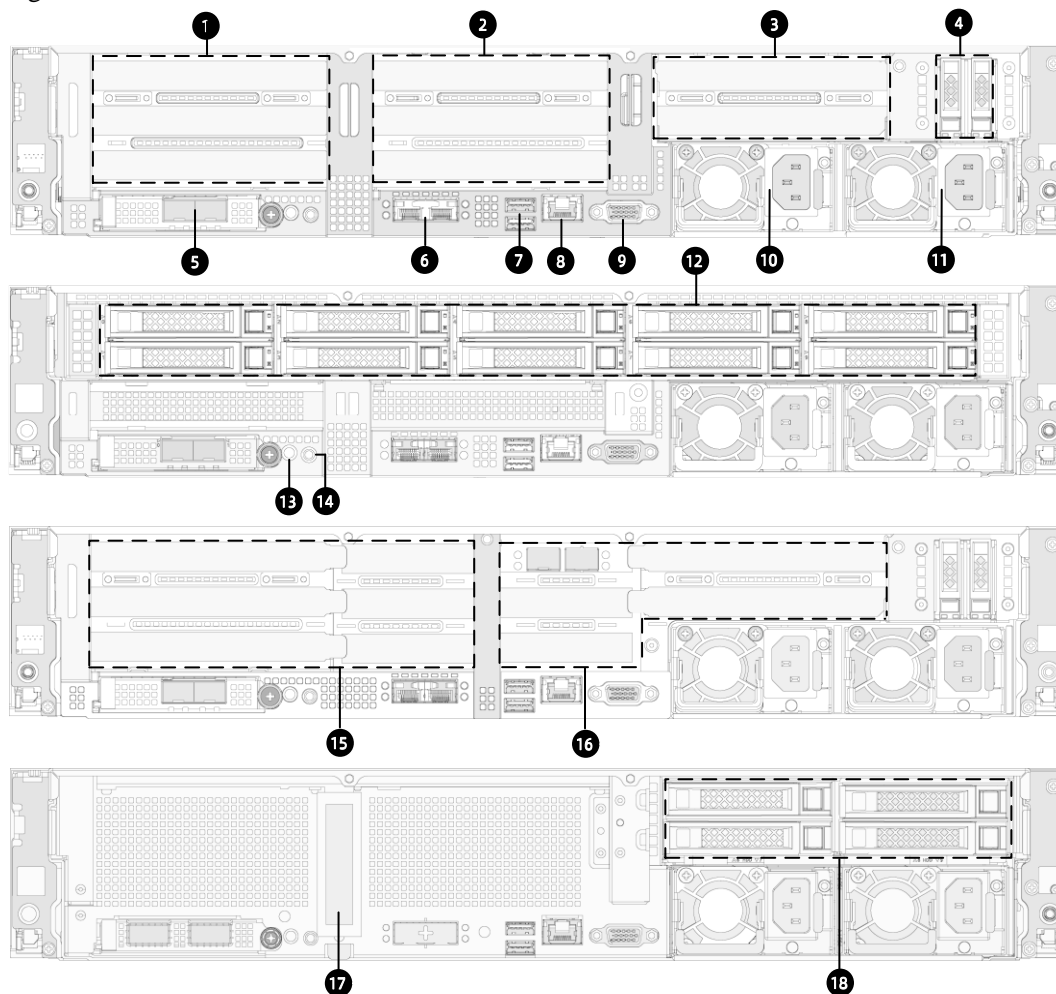

| # | Item                                      | #  | Item                     |
|---|---|----|--------------------------|
| 1 | PCIe_RISER2 Slot (Left Riser Card Slot)   | 10 | PSU0                     |
| 2 | PCIe_RISER1 Slot (Middle Riser Card Slot) | 11 | PSU1                     |
| 3 | PCIe_RISER0 Slot (Right Riser Card Slot)  | 12 | Rear 2.5" Drive Modules  |
| 4 | Rear M.2 Module                           | 13 | UID Button with LED      |
| 5 | OCP NIC 3.0 Module                        | 14 | System & BMC Serial Port |



| # | Item                                   | #  | Item                                     |
|---|--|----|--|
| 6 | X710 Dual 10G Network Port (SFP+ Port) | 15 | PCIe_RISER1 Slot (Left Riser Card Slot)  |
| 7 | USB 3.0 Port × 2                       | 16 | PCIe_RISER0 Slot (Right Riser Card Slot) |
| 8 | BMC Network Management Port            | 17 | PCIe_RISER1 Slot (Vertical)              |
| 9 | VGA Port                               | 18 | Rear 2.5" Drive Modules                  |

### 5.3 Internal Top View

Figure 5-8 Internal Top View

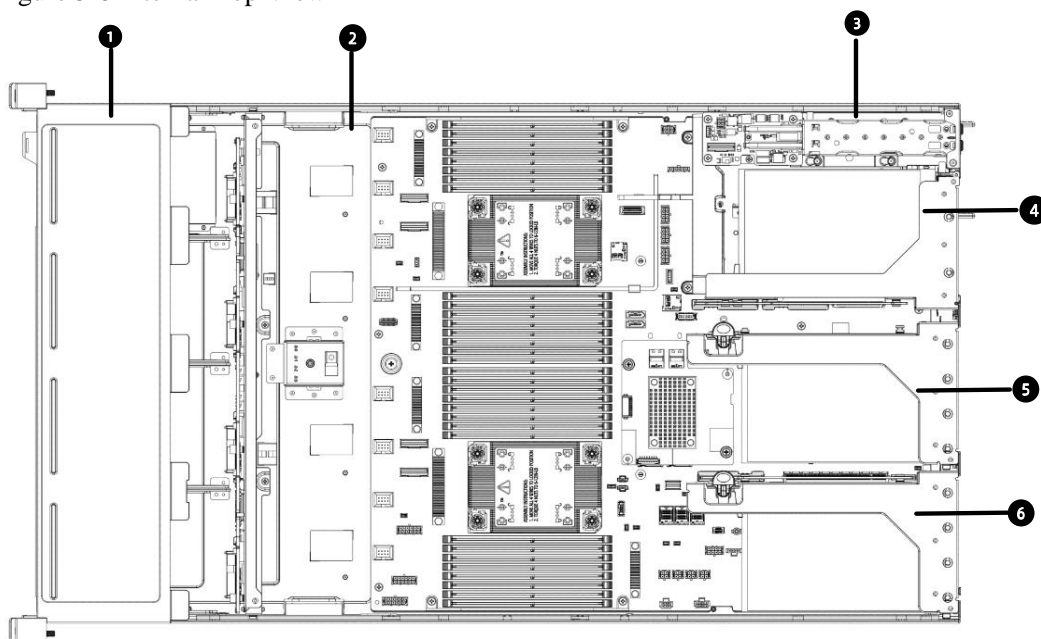

| # | Item             | # | Module              |
|---|------------------|---|---------------------|
| 1 | Drive Bays       | 4 | PCIe Riser 0 Module |
| 2 | System Fans      | 5 | PCIe Riser 1 Module |
| 3 | M.2/E1.S Bracket | 6 | PCIe Riser 2 Module |

### 5.4 OCP NIC 3.0 Module

Figure 5-9 OCP NIC 3.0 Module

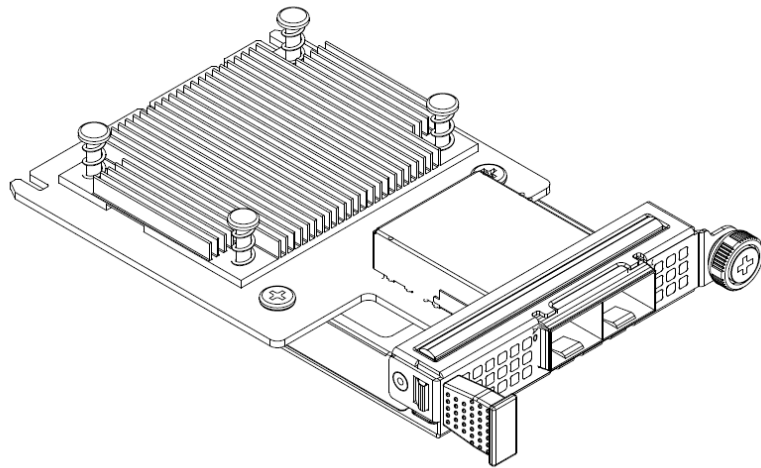

## 5.5 M.2

Figure 5-10 M.2 Module

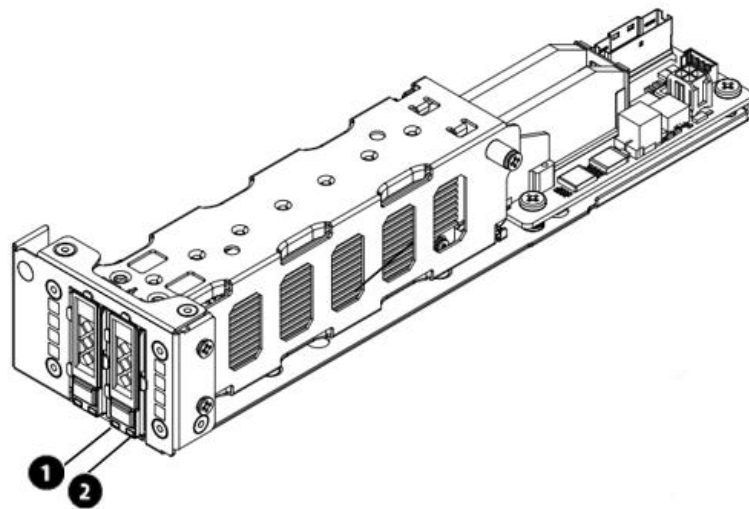

| # | Item                | Description  |
|---|---------------------|--|
| 1 | Activity Status LED | Solid green = Normal<br>Flashing green = Read/write activities   |
| 2 | Drive Fault LED     | Solid red = Drive error or failed<br>Solid blue = Drive is being located<br>Solid pink = RAID rebuilding |

## 5.6 E1.S

Figure 5-11 E1.S Module

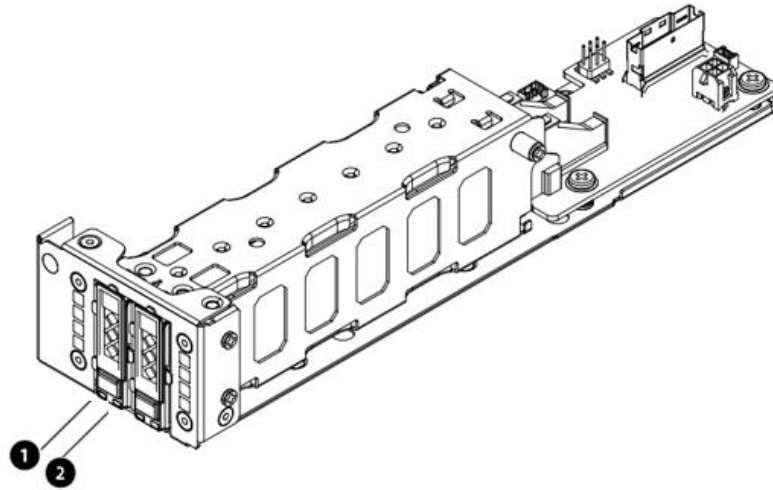

| # | Module              | Description  |
|---|---------------------|--|
| 1 | Activity Status LED | Solid green = Normal<br>Flashing green (4 Hz) = Read/write activities  |
| 2 | Drive Fault LED     | Solid amber = Drive error or failed<br>Flashing amber (4 Hz) = Drive is being located<br>Flashing amber (1 Hz) = RAID rebuilding |

## 5.7 Mainboard Layout

Figure 5-12 Mainboard Layout

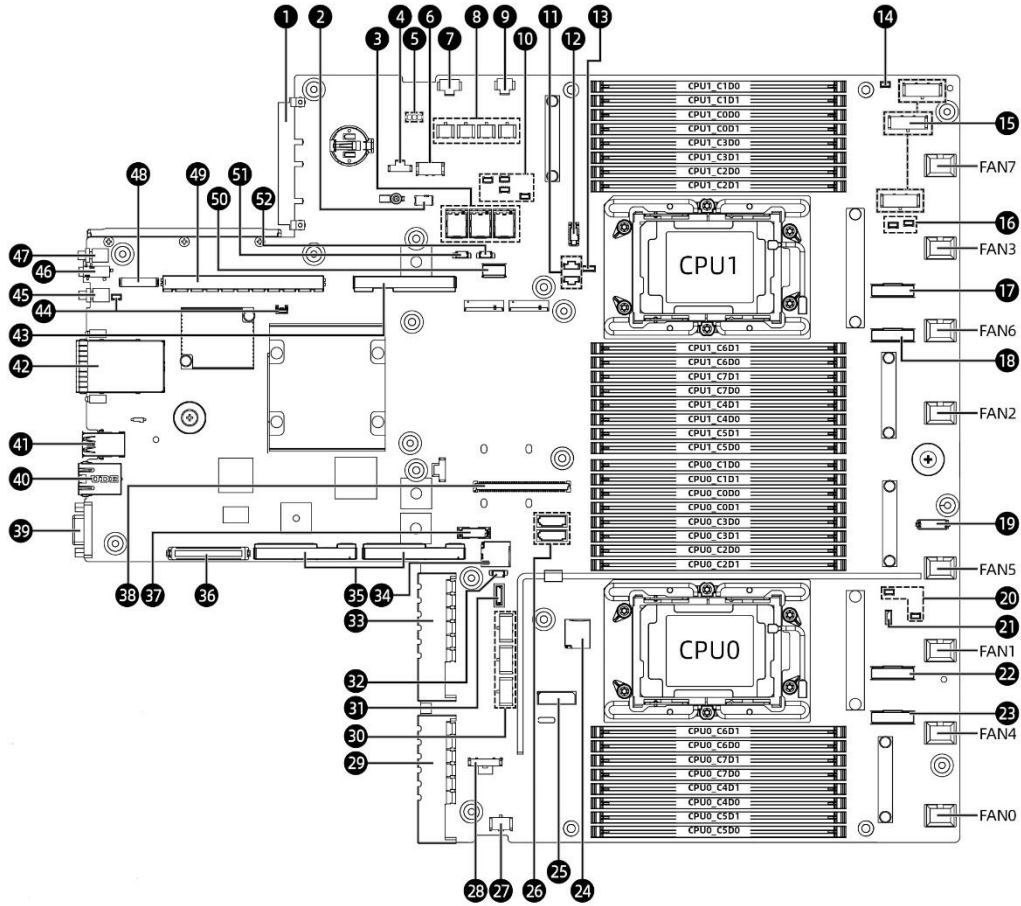

| # | Item                               | #  | Item                                 |
|---|------------------------------------|----|--------------------------------------|
| 1 | OCN NIC 3.0 Slot                   | 27 | B_M.2&3BP&GPU_RISER3 Power Connector |
| 2 | TPM Slot                           | 28 | Plate Capacitor Connector            |
| 3 | Mini_SAS Connector × 3             | 29 | PSU1 Connector                       |
| 4 | GPU_RISER0 Power Connector         | 30 | GPU Power Connector                  |
| 5 | CLR_CMOS Jumper Cap                | 31 | VROC Key Connector                   |
| 6 | GPU0&MID_PCIE Connector            | 32 | I2C4_GPU2 Connector                  |
| 7 | Mid-Backplane Power Connector      | 33 | PSU0 Connector                       |
| 8 | Rear Backplane Power Connector × 4 | 34 | BMC TF Card Slot                     |

| #  | Item                                    | #  | Item                                     |
|----|---|----|--|
| 9  | GPU0_RISER1&MID_PCIE Power Connector    | 35 | PCIE0_CPU0 Slot                          |
| 10 | I2C Connector × 4                       | 36 | PCIE0_CPU0 Power Connector               |
| 11 | CLK Connector × 2                       | 37 | NCSI Connector                           |
| 12 | VPP Connector                           | 38 | OCPA_CPU0 Slot                           |
| 13 | SGPIO Connector                         | 39 | VGA Connector                            |
| 14 | Sensor Connector                        | 40 | BMC Network Management Connector         |
| 15 | Front Backplane Power Connector × 3     | 41 | USB 3.0 Connector                        |
| 16 | I2C Connector × 2                       | 42 | SFP+ Connector                           |
| 17 | SLIM0_CPU1 Connector                    | 43 | PCIE1_CPU1 Slot                          |
| 18 | SLIM1_CPU1 Connector                    | 44 | Leakage Detection Connector × 2          |
| 19 | Left Mounting Ear Signal Line Connector | 45 | Power Button with LED                    |
| 20 | I2C Connector × 2                       | 46 | System & BMC Serial Port                 |
| 21 | Intrusion Switch Connector              | 47 | UID Button with LED                      |
| 22 | SLIM0_CPU0 Connector                    | 48 | PCIE1_CPU1 Power Connector               |
| 23 | SLIM1_CPU0 Connector                    | 49 | PCIE0_CPU1 Slot                          |
| 24 | SYS_TF Card Button                      | 50 | Right Mounting Ear Signal Line Connector |
| 25 | Debug Connector                         | 51 | I2C4_GPU4 Connector                      |
| 26 | SATA Connector × 2                      | 52 | I2C Connector                            |

# 6 System Specifications

Table 6-1 System Specifications

|                           |  |
|---------------------------|--|
| <b>Time to Market</b>     | 2021/04  |
| <b>Form Factor</b>        | 2U rack server   |
| <b>Processor</b>          | 1 to 2 Intel® Xeon® Scalable processors: <ul style="list-style-type: none"> <li>• Up to 40 cores</li> <li>• Max. speed of 3.6GHz</li> <li>• 3 UPI links and up to 11.2GT/s per link</li> <li>• TDP up to 270W</li> </ul>   |
| <b>Chipset</b>            | Intel C621A  |
| <b>Memory</b>             | <ul style="list-style-type: none"> <li>• Up to 32 DIMMs</li> <li>• 16 memory channels per processor, and up to 2 memory slots per channel</li> <li>• Up to 3200MT/s</li> <li>• RDIMMs, LRDIMMs and BPS supported</li> <li>• ECC, memory mirroring and memory rank sparing</li> </ul>   |
| <b>Storage</b>            | <ul style="list-style-type: none"> <li>• Front Panel <ul style="list-style-type: none"> <li>24 × 2.5" hot-swap SATA/SAS/NVMe drives</li> <li>25 × 2.5" hot-swap SATA/SAS drives</li> <li>12 × 2.5" hot-swap SATA/SAS drives</li> <li>12 × 3.5"/2.5" hot-swap SATA/SAS/NVMe drives</li> </ul> </li> <li>• Rear Panel <ul style="list-style-type: none"> <li>4 × 2.5" hot-swap SATA/SAS/NVMe SSDs</li> <li>4 × 3.5" hot-swap SATA/SAS/NVMe SSDs</li> <li>10 × 2.5" hot-swap SATA/SAS SSDs</li> </ul> </li> <li>• Rear Storage <ul style="list-style-type: none"> <li>2 optional SATA M.2 SSDs or 2 optional E1.S modules</li> </ul> </li> <li>• Built-in Storage <ul style="list-style-type: none"> <li>Up to 2 TF cards for BIOS and BMC respectively</li> <li>Up to 4x3.5" SATA/SAS</li> </ul> </li> </ul> |
| <b>Storage Controller</b> | <ul style="list-style-type: none"> <li>• RAID card controller</li> <li>• SAS card controller</li> <li>• Onboard PCH supports 14×SATA connectors (2 × SATA 7-pin + 3 × Mini SAS HD)</li> <li>• Intel onboard NVMe controller and optional Intel VROC Key</li> </ul>  NOTE<br>Intel VROC Key: RAID 0/1/10_Black and RAID 0/1/5/10_Red   |
| <b>Network</b>            | <ul style="list-style-type: none"> <li>• 1 optional OCP NIC 3.0 module (1Gb/s, 10Gb/s, 25Gb/s, 40Gb/s, 100Gb/s and 200Gb/s)</li> <li>• Dual 10G onboard network interfaces with the speed of 10Gb/s</li> <li>• Standard PCIe form factor: 1Gb/10Gb/25Gb/40Gb/100Gb NIC</li> </ul>  |
| <b>I/O Expansion Slot</b> | <ul style="list-style-type: none"> <li>• Up to 11 PCIe slots (10 x8 and 1 x16)</li> </ul>  |

|                          |  |
|--------------------------|--|
|                          | <ul style="list-style-type: none"> <li>• 4 dual-width GPUs or 8 single-width GPUs/graphic cards</li> <li>• 1 OCP NIC 3.0 (x16)</li> </ul>  |
| <b>Port</b>              | <ul style="list-style-type: none"> <li>• 2 rear USB 3.0 ports + 1 front USB 3.0 port + 1 front USB 2.0 port</li> <li>• 1 front VGA port</li> <li>• 1 rear VGA port</li> </ul>  |
| <b>Fan</b>               | 4 hot-swap 8056 fans of N+1 redundancy<br>8038 fans (N+1 redundancy is not supported)  |
| <b>Power Supply</b>      | 550W/800W/1300W/1600W/2000W CRPS power supply of 1+1 redundancy <ul style="list-style-type: none"> <li>• 110 VAC - 230 VAC: 90V - 264V</li> <li>• 240 VDC: 180V - 320V</li> <li>• 336 VDC: 260V - 400V</li> <li>• -48 VDC: -40V to -72V</li> </ul> |
| <b>System Management</b> | Integrated with 1 independent 1000Mbps network port, dedicated for IPMI remote management  |
| <b>Operating System</b>  | See Table 7-15 for detailed OS supported   |

Table 6-2 Physical Specifications

|                                   |  |
|-----------------------------------|--|
| <b>Chassis Dimensions</b>         | <ul style="list-style-type: none"> <li>• With lugs: 478.8mm (W) × 87mm (H) × 811.7mm (D)</li> <li>• Without lugs: 435mm (W) × 87mm (H) × 780mm (D)</li> </ul>  |
| <b>Outer Packaging Dimensions</b> | 1031mm (L) × 651mm (W) × 295mm (H)   |
| <b>Weight</b>                     | <ul style="list-style-type: none"> <li>• 12 × 3.5'' configuration (Rear 2.5-inch drives included)<br/>Net weight: 28Kg<br/>Gross weight: 37.5Kg (Chassis + Packaging Box + Rails + Accessory Box)</li> <li>• 25 × 2.5'' configuration (Rear 2.5-inch drives included)<br/>Net weight: 25.5Kg<br/>Gross weight: 35Kg (Chassis + Packaging Box + Rails + Accessory Box)</li> </ul> |
| <b>Temperature</b>                | <ul style="list-style-type: none"> <li>• Operating: 5°C - 45°C (35°C - 45°C for some models)</li> <li>• Storage (packed): -40°C to +70°C;</li> <li>• Storage (unpacked): -40°C to +55°C</li> </ul>   |
| <b>Humidity</b>                   | <ul style="list-style-type: none"> <li>• Operating: 5% - 90% R.H.</li> <li>• Storage (packed): 5% - 95% R.H.</li> <li>• Storage (unpacked): 5% - 95% R.H.</li> </ul>   |

|   |   |
|---|---|
| <p><b>Noise (Bels)<br/>(Sound power level)</b> <sup>4,5,6,7</sup></p> | <ul style="list-style-type: none"> <li>• Idle<br/>LWAd: 6.45B for normal configuration, 6.90B for high-end configuration<br/>LpAm: 49.0dBA for normal configuration, 55.8dBA for high-end configuration</li> <li>• Operating<br/>LWAd: 6.52B for normal configuration, 6.95B for high-end configuration<br/>LpAm: 49.8dBA for normal configuration, 56.4dBA for high-end configuration</li> </ul> |
| <p><b>Altitude</b></p>  | <ul style="list-style-type: none"> <li>• 0m - 914m (0ft - 3000ft)<br/>Operating temperature: 5°C - 45°C (41°F - 113°F)</li> <li>• 914m - 2133m (0ft - 7000ft):<br/>Operating temperature: 10°C - 32°C (50°F - 89.6°F)</li> </ul>  |

Table 6-3 Operating Temperature Specifications

| Model  | Max. Operating Temperature at 30°C   | Max. Operating Temperature at 35°C  | Max. Operating Temperature at 40°C   | Max. Operating Temperature at 45°C  |
|--|--|---|--|---|
| 8 × 2.5-inch drives  | All configurations   |   | <ul style="list-style-type: none"> <li>• CPUs with TDP higher than 220 W not supported</li> <li>• Passive-cooling GPUs not supported</li> <li>• BPS DIMMs not supported</li> </ul> | <ul style="list-style-type: none"> <li>• Passive-cooling GPUs not supported</li> <li>• Rear drives not supported</li> <li>• CPUs with TDP higher than 165 W not supported</li> <li>• DIMMs (including BPS) higher than 8 W not supported</li> </ul> |
| <p>12 × 3.5-inch EXP drives</p> <p>12 × 3.5-inch pass-through drives</p> | All configurations (When GPUs are equipped, there are restrictions on drive numbers and CPU power consumption) | <ul style="list-style-type: none"> <li>• Passive-cooling GPUs not supported</li> <li>• CPUs with TDP higher than 250 W not supported</li> <li>• Passive-</li> </ul> | <ul style="list-style-type: none"> <li>• Passive-cooling GPUs not supported</li> <li>• Rear drives not supported</li> <li>• CPUs with TDP higher than 165 W</li> </ul>             | Not supported   |



|                                   |  |  |  |   |
|-----------------------------------|--|--|--|---|
|                                   |  | cooling DIMMs (including BPS) higher than 8 W not supported  | not supported<br>• DIMMs (including BPS) higher than 6 W not supported   |   |
| 12 × 3.5-inch NVMe drives         | All configurations (When GPUs are equipped, there are restrictions on drive numbers and CPU power consumption) | <ul style="list-style-type: none"> <li>• Passive-cooling GPUs not supported</li> <li>• CPUs with TDP higher than 250 W not supported</li> <li>• Passive-cooling DIMMs (including BPS) higher than 8 W not supported</li> </ul> | <ul style="list-style-type: none"> <li>• Passive-cooling GPUs not supported</li> <li>• CPUs with TDP higher than 205 W not supported</li> <li>• DIMMs (including BPS) higher than 8 W not supported</li> </ul> | <ul style="list-style-type: none"> <li>• Passive-cooling GPUs not supported</li> <li>• Rear drives not supported</li> <li>• CPUs with TDP higher than 165 W not supported</li> <li>• DIMMs (including BPS) higher than 6 W not supported</li> </ul> |
| 24 × 2.5-inch pass-through drives |  |  |  |   |
| 24 × 2.5-inch NVMe drives         |  |  |  |   |

Note:

- Not all configurations support an operating temperature range of 5°C - 45°C (41°F - 113°F). The GPU configuration supports an operating temperature range of 10°C - 30°C (50°F - 86°F). Some CPUs with high power consumption support an operating temperature range of 10°C - 35°C (50°F - 95°F). The supported configurations above do not include the liquid-cooled CPU 8368Q (QWMQ).
- Standard operating temperature: 10°C - 35°C at sea level (50°F - 95°F). Every 305m increase in the altitude above sea level reduces the operating temperature range by 1.0°C (a 1.8°F drop per 1000 ft). The maximum operating altitude is 3050m (10,000ft). Please keep the system away from direct sunlight. The maximum rate of change is 20°C/hr (36°F/hr). The operating altitude and maximum rate of change vary with different system configurations. Any fan failure or operations above 30°C (86°F) may lead to system performance degradation.
- Extended operating temperature: As for certain approved configurations, the supported entry range of the system can be extended to 5°C - 10°C (41°F - 50°F) and 35°C - 45°C (95°F - 104°F) at sea level. At an altitude of 900 - 3050 m (2953ft - 10,000ft) above sea level, every 175 m increase in the altitude reduces the operating temperature range by 1.0°C (a 1.8°F drop per 574ft). As for certain approved configurations, the supported entry range of the system at sea level can be extended to 35°C - 45°C (104°F - 113°F). At an altitude of 900m - 3050m (2953ft - 10,000ft) above sea level, every 125m increase in the altitude reduces the operating temperature range by 1.0°C (a 1.8°F drop per 410ft). Any fan failure or operations under extended environments may lead to system performance degradation.

- This document lists the weighted sound power level (LWAd) and the weighted sound pressure level (LpAm) of the product at an operating temperature of 23°C (73.4°F). The values were reported according to the ISO 7779 (ECMA 74) noise measurement standards and ISO 9296 (ECMA 109). The listed sound levels are applicable to general shipping configurations and other options may increase the volume. Please contact your sales representative for more information.
- The sound levels shown here were measured based on specific test configurations. The sound level will vary with different system configurations. Values are subjected to change without notice and are for reference only.
- The sample (model) test assessments meet the referenced product specifications. This product or product series are eligible to have appropriate compliance labels and declarations.
- All sound levels listed are for standard shipping configurations and other system configurations may increase the volume.

Table 6-4 Safety & EMC

|        |   |
|--------|---|
| Safety | GB4943.1-2011<br>IEC 60950-1:2005, IEC 60950-1:2005/AMD1:2009, IEC 60950-1:2005/AMD2:2013<br>IEC 62368-1:2014 (Second Edition)<br>EN 62368-1:2014+A11:2017<br>UL 62368-1, 2nd Ed., Issue Date: 2014-12-01<br>TP TC 004/2011<br>IEC 62368-1:2014 including AU/NZ deviations<br>IS 13252(Part 1):2010/ IEC 60950-1 : 2005   |
| EMC    | GB/T 9254-2008<br>GB17625.1-2012<br>CFR 47 FCC Part 15 subpart B, 2020 AND ANSI C63.4-2014<br>CISPR 32:2015+A1:2019; CISPR 24:2010+A1:2015<br>EN 55032:2015+A11:2020; EN 61000-3-2:2019<br>EN 610 EN 55024:2010+A1:201500-3-3:2013+A1:2019<br>EN 55035:2017+A11:2020<br>KN32<br>KN35<br>CISPR 32:2015+A1:2019,CISPR 24:2013,EN 55032:2015+A1:2019,EN IEC 61000-3-2:2019.EN 61000-3-3:2013+A1:2019,EN 55035:2017<br>TP TC 020/2011 |

Table 6-5 Industry Standard Compliance

|                                    |
|------------------------------------|
| ACPI 6.1 Compliant                 |
| PCI-E 4.0 Compliant                |
| WOL Support                        |
| SMBIOS 3.1                         |
| UEFI 2.6                           |
| Redfish API                        |
| IPMI 2.0                           |
| Microsoft® Logo Certifications     |
| PXE Support                        |
| Advanced Encryption Standard (AES) |
| SNMP v3                            |
| TLS 1.2                            |
| Active Directory V1.0              |

|                       |
|-----------------------|
| TPM                   |
| TCM                   |
| USB 2.0/3.0 Compliant |

# 7 Compatibility List

※ The compatibility list was updated on 2021/02. For the latest compatibility configuration and the parts and models not listed in this manual, please contact Inspur Customer Service.

## 7.1 Processor

NF5280M6 supports two Intel® Xeon® Scalable processors.

Table 7-1 CPU

| Model | Cores | Threads | Base Frequency | Max. Turbo Frequency | Cache | TDP  |
|-------|-------|---------|----------------|----------------------|-------|------|
| 8380  | 40    | 80      | 2.30GHz        | 3.40GHz              | 60MB  | 270W |
| 8352Y | 32    | 64      | 2.20GHz        | 3.40GHz              | 48MB  | 205W |
| 8360Y | 36    | 72      | 2.40GHz        | 3.50GHz              | 54MB  | 250W |
| 8352V | 36    | 72      | 2.10GHz        | 3.50GHz              | 54MB  | 195W |
| 8368  | 38    | 76      | 2.40GHz        | 3.40GHz              | 57MB  | 270W |
| 8351N | 36    | 72      | 2.40GHz        | 3.50GHz              | 54MB  | 225W |
| 8358P | 32    | 64      | 2.60GHz        | 3.40GHz              | 48MB  | 240W |
| 8358  | 32    | 64      | 2.60GHz        | 3.40GHz              | 48MB  | 250W |
| 8352S | 32    | 64      | 2.20GHz        | 3.40GHz              | 48MB  | 205W |
| 6342  | 24    | 48      | 2.80GHz        | 3.50GHz              | 36MB  | 230W |
| 6336Y | 24    | 48      | 2.40GHz        | 3.60GHz              | 36MB  | 185W |
| 6314U | 32    | 64      | 2.30GHz        | 3.40GHz              | 48MB  | 205W |
| 6354  | 18    | 36      | 3.00GHz        | 3.60GHz              | 39MB  | 205W |
| 6348  | 28    | 56      | 2.60GHz        | 3.50GHz              | 42MB  | 235W |
| 6338  | 32    | 64      | 2.00GHz        | 3.20GHz              | 48MB  | 205W |
| 6330N | 28    | 56      | 2.20GHz        | 3.40GHz              | 42MB  | 165W |
| 6338N | 32    | 64      | 2.20GHz        | 3.50GHz              | 48MB  | 185W |
| 6330  | 28    | 56      | 2.00GHz        | 3.10GHz              | 42MB  | 205W |
| 6346  | 16    | 32      | 3.10GHz        | 3.60GHz              | 24MB  | 205W |
| 5317  | 12    | 24      | 3.00GHz        | 3.60GHz              | 18MB  | 150W |
| 5318N | 24    | 48      | 2.10GHz        | 3.40GHz              | 36MB  | 150W |
| 5315Y | 8     | 16      | 3.20GHz        | 3.60GHz              | 12MB  | 140W |
| 5320  | 26    | 52      | 2.20GHz        | 3.40GHz              | 39MB  | 185W |
| 5318Y | 24    | 48      | 2.10GHz        | 3.40GHz              | 36MB  | 165W |
| 4316  | 20    | 40      | 2.30GHz        | 3.40GHz              | 30MB  | 150W |
| 4309Y | 8     | 16      | 2.80GHz        | 3.60GHz              | 12MB  | 105W |
| 4310  | 12    | 24      | 2.10GHz        | 3.30GHz              | 18MB  | 120W |

|       |    |    |         |         |      |      |
|-------|----|----|---------|---------|------|------|
| 4310T | 10 | 20 | 2.30GHz | 3.40GHz | 15MB | 105W |
| 4314  | 16 | 32 | 2.40GHz | 3.40GHz | 24MB | 135W |

## 7.2 Memory

NF5280M6 supports up to 32 DDR4 DIMMs. Each processor supports 16 memory channels, and each channel supports 2 memory slots. NF5280M6 supports RDIMMs/LRDIMMs/BPS, and the following memory protection technologies:

- Partial Cache Line Sparing (PCLS)
- DDR4 Command/Address Parity Check and Retry
- Memory Demand and Patrol Scrubbing
- Memory Data Scrambling with Command and Address
- Memory Mirroring-Intra iMC
- PMem Single Device Data Correction (SDDC)
- PMem Double Device Data Correction (DDDC)
- DDRT Data ECC (Read & Write)
- PMem Address Verification and Retry
- PMem Memory Address Range Scrub (ARS)
- DDR4 Write Data CRC Check and Retry
- Memory disable/map-out for FRB
- Power-up DDR4 Post Package Repair (PPR)
- Failed DIMM Isolation
- Address range/partial memory mirroring

Table 7-2 Memory List

| Model                 | Max. Capacity | Description |
|-----------------------|---------------|-------------|
| M393A2K40DB3-CWE      | 32×16GB       | RDIMM@3200  |
| M393A2K43DB3-CWE      | 32×16GB       | RDIMM@3200  |
| MTA18ASF2G72PDZ-3G2E1 | 32×16GB       | RDIMM@3200  |
| M393A4K40DB3-CWE      | 32×32GB       | RDIMM@3200  |
| MTA18ASF4G72PDZ-3G2E1 | 32×32GB       | RDIMM@3200  |
| MTA36ASF4G72PZ-3G2E7  | 32×32GB       | RDIMM@3200  |
| HMA84GR7DJR4N-XN      | 32×32GB       | RDIMM@3200  |
| HMAA4GR7AJR8N-XN      | 32×32GB       | RDIMM@3200  |
| HMA84GR7CJR4N-XN      | 32×32GB       | RDIMM@3200  |
| M393A4G43AB3-CWE      | 32×32GB       | RDIMM@3200  |
| M393A8G40AB2-CWE      | 32×64GB       | RDIMM@3200  |
| NMB1XXD128GPS         | 16×128GB      | BPS@3200    |



### NOTE

- The server does not support mixed use of DIMMs of different types and specifications, except the BPS.
- Two processors can maximize the memory capacity. When only one processor is installed, the maximum memory capacity is half of the displayed capacity.

Table 7-3 DDR4 Population Methods

| CPU0 |    |    |    |    |    |    |    |    |    |    |    |    |    | CPU1 |    |  |  |  |  |  |  |  |  |  |  |  |  |
|------|----|----|----|----|----|----|----|----|----|----|----|----|----|------|----|--|--|--|--|--|--|--|--|--|--|--|--|
| C0   | C1 | C2 | C3 | C4 | C5 | C6 | C7 | C0 | C1 | C2 | C3 | C4 | C5 | C6   | C7 |  |  |  |  |  |  |  |  |  |  |  |  |
| D    | D  | D  | D  | D  | D  | D  | D  | D  | D  | D  | D  | D  | D  | D    | D  |  |  |  |  |  |  |  |  |  |  |  |  |
| 0    | 1  | 0  | 1  | 0  | 1  | 0  | 1  | 0  | 1  | 0  | 1  | 0  | 1  | 0    | 1  |  |  |  |  |  |  |  |  |  |  |  |  |
| v    |    |    |    |    |    |    |    |    |    |    |    |    |    |      |    |  |  |  |  |  |  |  |  |  |  |  |  |
| v    |    |    |    |    |    |    |    | v  |    |    |    |    |    |      |    |  |  |  |  |  |  |  |  |  |  |  |  |
| v    |    |    |    | v  |    |    |    | v  |    |    |    | v  |    |      |    |  |  |  |  |  |  |  |  |  |  |  |  |
| v    |    | v  |    | v  |    | v  |    | v  |    | v  |    | v  |    | v    |    |  |  |  |  |  |  |  |  |  |  |  |  |
| v    | v  | v  |    | v  | v  | v  |    | v  | v  | v  |    | v  | v  | v    |    |  |  |  |  |  |  |  |  |  |  |  |  |
| v    | v  | v  | v  | v  | v  | v  | v  | v  | v  | v  | v  | v  | v  | v    | v  |  |  |  |  |  |  |  |  |  |  |  |  |
| v    | v  | v  | v  | v  | v  | v  | v  | v  | v  | v  | v  | v  | v  | v    | v  |  |  |  |  |  |  |  |  |  |  |  |  |

Table 7-4 BPS Population Methods

| CPU0 |    |      |    |      |    |      |    |      |    |      |    |      |    | CPU1 |    |  |  |  |  |  |  |  |  |  |  |  |  |
|------|----|------|----|------|----|------|----|------|----|------|----|------|----|------|----|--|--|--|--|--|--|--|--|--|--|--|--|
| iMC0 |    | iMC1 |    | iMC2 |    | iMC3 |    | iMC0 |    | iMC1 |    | iMC2 |    | iMC3 |    |  |  |  |  |  |  |  |  |  |  |  |  |
| C0   | C1 | C2   | C3 | C4   | C5 | C6   | C7 | C0   | C1 | C2   | C3 | C4   | C5 | C6   | C7 |  |  |  |  |  |  |  |  |  |  |  |  |
| D    | D  | D    | D  | D    | D  | D    | D  | D    | D  | D    | D  | D    | D  | D    | D  |  |  |  |  |  |  |  |  |  |  |  |  |
| 0    | 1  | 0    | 1  | 0    | 1  | 0    | 1  | 0    | 1  | 0    | 1  | 0    | 1  | 0    | 1  |  |  |  |  |  |  |  |  |  |  |  |  |
| D    | B  | D    | B  | D    | B  | D    | B  | D    | B  | D    | B  | D    | B  | D    | B  |  |  |  |  |  |  |  |  |  |  |  |  |
| D    | D  | D    | B  | D    | D  | D    |    | D    | D  | D    | B  | D    | D  | D    |    |  |  |  |  |  |  |  |  |  |  |  |  |
| D    | B  | D    | D  | D    | D  | D    | D  | D    | B  | D    | D  | D    | D  | D    | D  |  |  |  |  |  |  |  |  |  |  |  |  |
| D    | B  | D    | D  | B    | D  | D    | D  | D    | B  | D    | D  | B    | D  | D    | D  |  |  |  |  |  |  |  |  |  |  |  |  |
| D    | B  | D    | B  | D    | B  | D    | B  | D    | B  | D    | B  | D    | B  | D    | B  |  |  |  |  |  |  |  |  |  |  |  |  |
| D    | D  | B    | D  | D    | D  | D    | B  | D    | D  | B    | D  | D    | D  | D    | D  |  |  |  |  |  |  |  |  |  |  |  |  |



- B=BPS; D=RDIMM/LRDIMM

## 7.3 Storage

### 7.3.1 SATA/SAS Drive Models

Table 7-5 Drive Options

| Type     | Model        | Rpm | Capacity |
|----------|--------------|-----|----------|
| 2.5" SAS | ST600MM0009  | 10K | 600G     |
|          | ST1200MM0009 | 10K | 1.2T     |
|          | AL15SEB060N  | 10k | 600G     |
|          | AL15SEB120N  | 10K | 1.2T     |
|          | AL15SEB18EQ  | 10K | 1.8T     |
|          | AL15SEB24EQ  | 10K | 2.4T     |
|          | ST1800MM0129 | 10K | 1.8T     |

|           |                 |      |      |
|-----------|-----------------|------|------|
|           | ST2400MM0129    | 10K  | 2.4T |
| 3.5" SATA | ST2000NM000A    | 7.2K | 2T   |
|           | ST4000NM000A    | 7.2K | 4T   |
|           | ST8000NM000A    | 7.2K | 8T   |
|           | ST6000NM021A    | 7.2K | 6T   |
|           | ST16000NM001G   | 7.2K | 16T  |
|           | ST14000NM001G   | 7.2K | 14T  |
|           | ST12000NM001G   | 7.2K | 12T  |
|           | ST4000NM002A    | 7.2K | 4T   |
|           | WUH721818ALE6L4 | 7.2K | 16T  |
|           | WUH721414ALE6L4 | 7.2K | 14T  |
|           | HUS728T8TALE6L4 | 7.2K | 8T   |
|           | HUS726T4TALA6L4 | 7.2K | 4T   |
|           | WUH721818ALE6L4 | 7.2K | 18T  |
|           | HUH721212ALE600 | 7.2K | 12T  |
|           | HUS722T2TALA604 | 7.2K | 2T   |
|           | MG06ACA10TE     | 7.2K | 10T  |
|           | MG06ACA800E     | 7.2K | 8T   |



## NOTE

2.5" drives and 3.5" drives can be used together. Front drives support mixed use of three common types, and NVMe and rear drives support mixed use of two types.

## 7.3.2 SSD Models

Table 7-6 SSD Options

| Type     | Model         | Capacity |
|----------|---------------|----------|
| SATA SSD | SSDSC2KB240G8 | 240G     |
|          | SSDSC2KB480G8 | 480G     |
|          | SSDSC2KB960G8 | 960G     |
|          | SSDSC2KB019T8 | 1.92T    |
|          | SSDSC2KB038T8 | 3.84T    |
|          | SSDSC2KB076T8 | 7.68T    |
|          | MZ7LH240HAHQ  | 240G     |
|          | MZ7LH480HAHQ  | 480G     |
|          | MZ7LH960HAJR  | 960G     |
|          | MZ7LH1T9HMLT  | 1.92T    |
|          | MZ7LH3T8HMLT  | 3.84T    |
|          | MTFDDAK240TDS | 240G     |
|          | MTFDDAK480TDS | 480G     |

|  |               |       |
|--|---------------|-------|
|  | MTFDDAK960TDS | 960G  |
|  | MTFDDAK1T9TDS | 1.92T |
|  | MTFDDAK3T8TDS | 3.84T |
|  | MTFDDAK7T6TDS | 7.68T |
|  | MTFDDAK240TDT | 240G  |
|  | MTFDDAK480TDT | 480G  |
|  | MTFDDAK960TDT | 960G  |
|  | MTFDDAK1T9TDT | 1.92T |
|  | MTFDDAK3T8TDT | 3.84T |
|  | SSDSC2KG240G8 | 240G  |
|  | SSDSC2KG480G8 | 480G  |
|  | SSDSC2KG960G8 | 960G  |
|  | SSDSC2KG019T8 | 1.92T |
|  | SSDSC2KG038T8 | 3.84T |
|  | SSDSC2KG076T8 | 7.68T |

### 7.3.3 U.2 NVMe SSDs

Table 7-7 U.2 NVMe SSDs

| Model         | Capacity |
|---------------|----------|
| SSDPE2KX010T8 | 1T       |
| SSDPE2KX020T8 | 2T       |
| SSDPE2KX040T8 | 4T       |
| SSDPE2KX080T8 | 8T       |
| SSDPE2KE016T8 | 1.6T     |
| SSDPE2KE032T8 | 3.2T     |
| SSDPE2KE064T8 | 6.4T     |
| SSDPE2KE076T8 | 7.68T    |
| MZQL2960HCJR  | 960G     |
| MZQL21T9HCJR  | 1.92T    |
| MZQL23T8HCLS  | 3.84T    |
| SSDPF2KX076TZ | 7.68T    |
| SSDPF2KX038TZ | 3.84T    |

## 7.4 Drive Backplane

Table 7-8 Drive Backplanes

| Type | Description | Support |
|------|-------------|---------|
|------|-------------|---------|



|   |   |   |
|---|---|---|
| Front 4 × 3.5" SAS SATA Backplane         | Backplane_Inspur_NF5280M6_3.5 × 4_SAS_SATA        | <ul style="list-style-type: none"> <li>SAS/SATA drives via RAID or SAS cards</li> <li>PCH onboard SATA</li> </ul>   |
| Front 4 × 3.5" SAS SATA NVMe Backplane    | Backplane_Inspur_5280M6_3.5 × 4_SAS_SATA_NVMe_GN4 | <ul style="list-style-type: none"> <li>SAS/SATA drives via RAID and SAS cards</li> <li>Four NVMe drives</li> </ul>  |
| Front 12 × 3.5" Pass-through Backplane    | Backplane_Inspur_ZT_SAS_SATA_3.5 × 12             | <ul style="list-style-type: none"> <li>SAS/SATA drives via RAID and SAS cards</li> <li>PCH onboard SATA</li> </ul>  |
| Front 8 × 2.5" 6 × SAS 2 × NVMe Backplane | Backplane_Inspur_5280M6_2.5 × 8_6SAS_2NVMe_GEN4   | <ul style="list-style-type: none"> <li>SAS/SATA drives via RAID and SAS cards</li> <li>The last two slots support NVMe drives</li> </ul>  |
| Front 8 × 2.5" 8 × SAS 8 × NVMe Backplane | Backplane_Inspur_NF5280M6_2.5 × 8_8SAS_8NVMe_Gen4 | <ul style="list-style-type: none"> <li>SAS/SATA drives via RAID and SAS cards</li> <li>Eight NVMe drives</li> </ul>   |
| Front 12 × 3.5" Expander Backplane        | Backplane_Inspur_SAS_SATA_3.5 × 12                | <ul style="list-style-type: none"> <li>SAS/SATA drives via RAID and SAS cards</li> <li>Optional cascading support</li> <li>A cascaded rear backplane supports up to 4 drives</li> <li>Alternative expander chip vendors from Broadcom and from Microchip</li> </ul> |
| Front 25 × 2.5" Expander Backplane        | Backplane_Inspur_SAS_SATA_2.5 × 25                | <ul style="list-style-type: none"> <li>SAS/SATA drives through RAID and SAS cards</li> <li>A cascaded rear backplane supports up to 3 drives</li> </ul>   |
| Rear M.2 Backplane                        | Backplane_Inspur_NF5280M6_M.2 × 2_NVMe_SATA       | <ul style="list-style-type: none"> <li>SATA M.2 drives via RAID and SAS cards</li> <li>PCH onboard SATA</li> <li>Cascade to front Expander backplanes</li> </ul>  |
| Rear 2 × 2.5" SAS/SATA Backplane          | Backplane_Inspur_Backplane_2.5 × 2_SAS_SATA       | <ul style="list-style-type: none"> <li>SAS/SATA drives via RAID and SAS cards</li> <li>PCH onboard SATA</li> <li>Cascade to front Expander backplanes</li> </ul>  |
| Rear 2 × 2.5" NVMe Backplane              | Backplane_Inspur_NVMe_2 × 2.5_Slim x8             | Only NVMe drives  |
| Rear 2 × 3.5" SATA/SAS Backplane          | Backplane_Inspur_Backplane_3.5 × 2_SAS_SATA       | SAS/SATA drives via RAID and SAS cards  |
| Rear 8 × 2.5" SAS/SATA Backplane          | Backplane_Inspur_SAS_SATA_8 × 2.5_Slim x4         | SAS/SATA drives via RAID and SAS cards  |
| Rear 2 × E1.S Backplane                   | Backplane_Inspur_PCIE x8_2 × Ruler                | Two E1.S  |

## 7.5 Drive Installation Position

### 7.5.1 HDD Installation Sequence

Figure 7-1 Front 12 × 3.5"

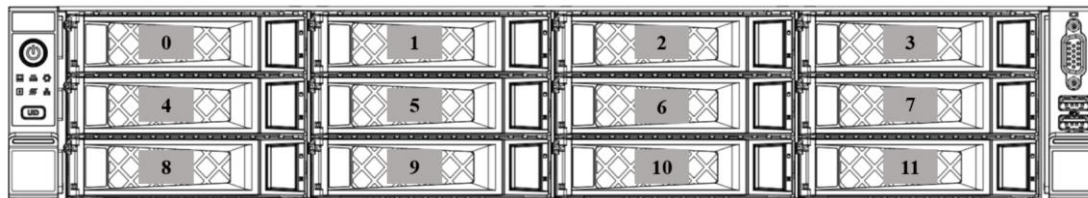

Figure 7-2 Front (8 × 2.5") × 3

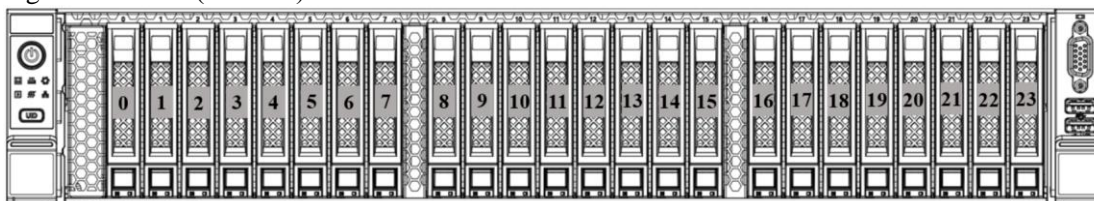

Figure 7-3 Front 25 × 2.5"

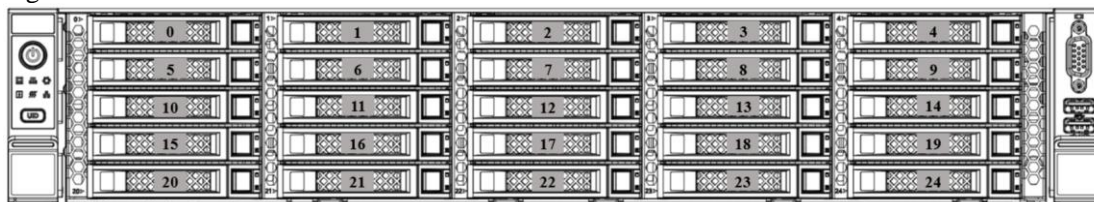

Figure 7-4 Rear (2 × 2.5"/2 × 3.5") × 2

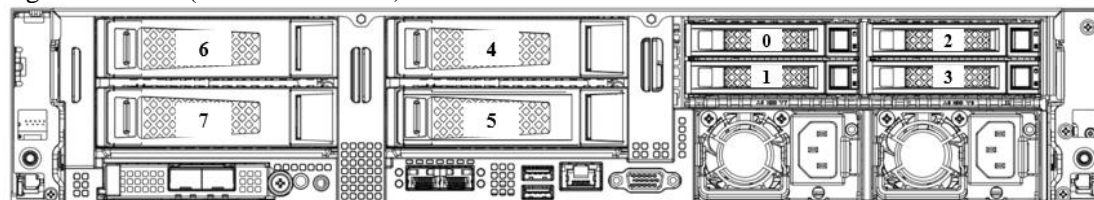
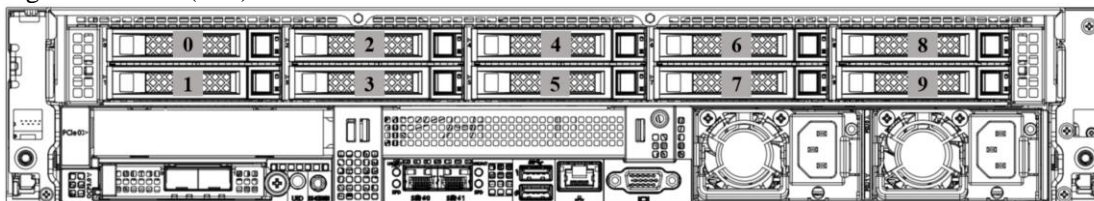

Figure 7-5 Rear (8+2) × 2.5"



### 7.5.2 NVMe Drive Installation Position

1. Backplane: (4 × 3.5" 4 × NVMe) × 3



The connectors for NVMe drives on the backplane are compatible with SAS/SATA drives

- Only NVMe drives: Install in the sequence from NVMe0 to NVMe11.
- Both HDDs and NVMe drives
  - HDD: Install in the sequence from NVMe0 to NVMe11
  - NVMe drives: Install in the sequence from NVMe11 to NVMe0

Figure 7-6 NVMe Drive Bay Sequence

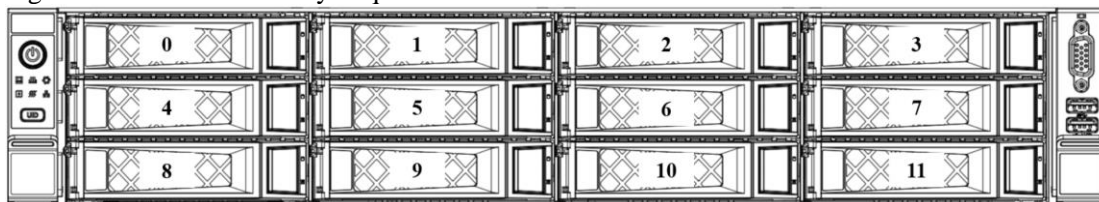

2. Backplane:  $(8 \times 2.5'' \ 2 \times \text{NVMe}) \times (1/2/3)$



NOTE

The connectors for NVMe drives on the backplane are compatible with SAS/SATA drives

- Install SATA/SAS drives from left to right
- Install NVMe drives in the last two slots according to the total number of drives

Figure 7-7 NVMe Installation Bays under 1-Backplane Configuration

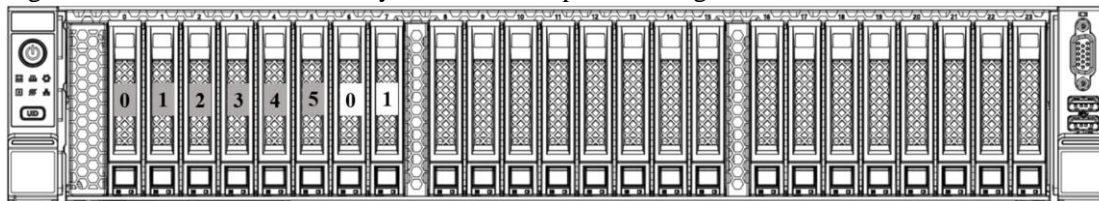

Figure 7-8 NVMe Installation Bays under 2-Backplane Configuration

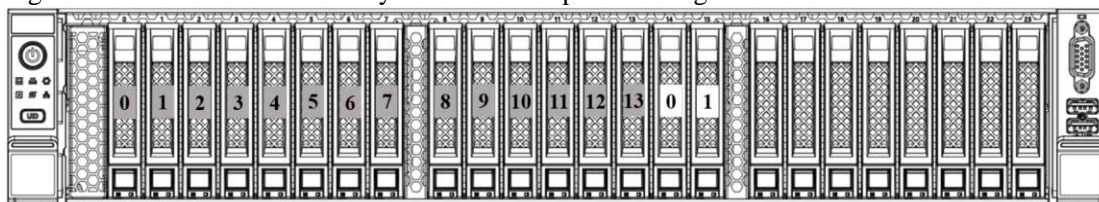
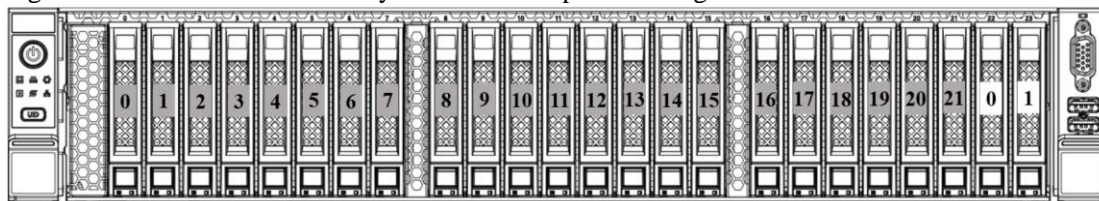

Figure 7-9 NVMe Installation Bays under 3-Backplane Configuration



3. Backplane:  $(8 \times 2.5'' \ 24 \times \text{NVMe})$



NOTE

The connectors for NVMe drives on the backplane are compatible with SAS/SATA drives

- Only NVMe drives: Install in the sequence from NVMe0 to NVMe23.
- Both HDDs and NVMe drives
  - HDD: Install in the sequence from NVMe0 to NVMe23
  - NVMe drives: Install in the sequence from NVMe23 to NVMe0

Figure 7-10 NVMe Drive Bay Sequence

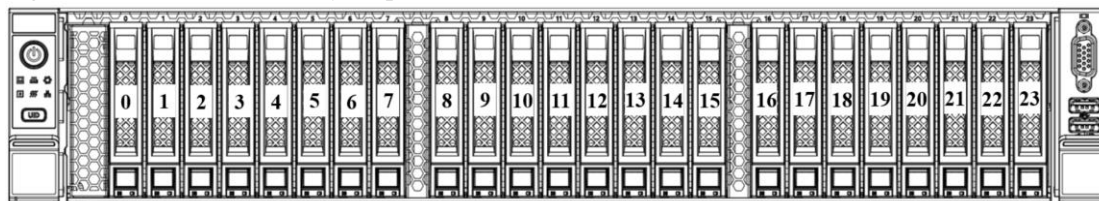

4. Backplane: (2 × 2.5” NVMe) × 2



The backplane only supports NVMe drives.

- Only NVMe drives: Install in the sequence from NVMe0 to NVMe3

Figure 7-11 Rear NVMe Drive Bay Sequence

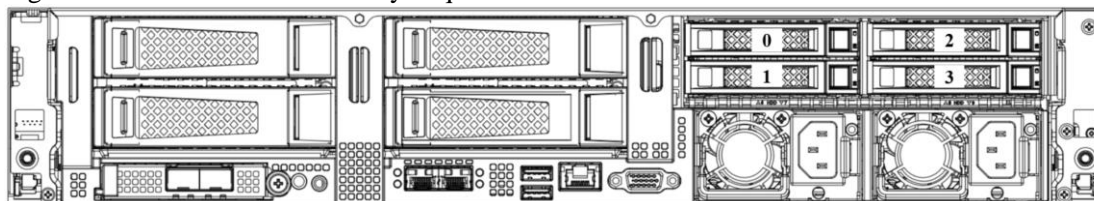

## 7.6 RAID/SAS Card

Table 7-9 RAID/SAS Cards

| Type      | Manufacturer | Description                                | Support Super-Capacitor |
|-----------|--------------|--|-------------------------|
| SAS Card  | Inspur       | SAS Card_L_8R0_3408IT_HDM12G_PCIE3_Mezz    | No                      |
|           |              | SAS_INSPUR_SAS3008+IR+PCIE3.0              | No                      |
| RAID Card | Inspur       | RAID Card_L_8R0_3508_4GB_HDM12G_PCIE3_Mezz | Yes                     |
|           | Broadcom     | RAID Card_L_8R0_9460-8i_2GB_HDM12G_PCIE3   | Yes                     |

## 7.7 NIC

Table 7-10 OCP 3.0 NICs

| Type | Model & Description                      | Speed | Interfaces |
|------|--|-------|------------|
| OCP  | NIC_M_200G_MCX623435AN_LC_OCP3x16_XR     | 200G  | 2          |
|      | NIC_M_100G_MCX566ACDAB_LC_OCP3x16_2_XR   | 100G  | 2          |
|      | NIC_M_100G_MCX623436AN_LC_OCP3x16_2_XR   | 100G  | 2          |
|      | NIC_M_25G_MCX562A-ACAB_LC_OCP3x16_2_XR   | 25G   | 2          |
|      | NIC_BROADCM_25G_57414_LC_OCP3x16_2_XR    | 25G   | 2          |
|      | NIC_M_25G_MCX4621A-ACAB_LC_OCP3x8_2_XR   | 25G   | 2          |
|      | NIC_I_25G_E810XXVDA2_LC_OCP3x8_2_XR      | 25G   | 2          |
|      | NIC_Inspur_Andes-M6_E810_25G_LC_OCP3x8_2 | 25G   | 2          |
|      | NIC_M_25G_MCX631432AN_LC_OCP3x8_2_XR     | 25G   | 2          |
|      | NIC_Inspur_Andes-M6_X710_10G_LC_OCP3x8_2 | 10G   | 2          |

Table 7-11 Standard PCI-E NICs

| Type | Model & Description                      | Speed | Interfaces |
|------|--|-------|------------|
| PCIe | NIC_SND_1G_I350-AM2_RJ_PCIEx4_2_XR       | 1G    | 2          |
|      | NIC_I_10G_X550T2_RJ_PCIEx4_2_XR          | 10G   | 2          |
|      | NIC_INSPUR_X710_10G_LC_PCIEx8_双_XR_子卡    | 10G   | 2          |
|      | NIC_INSPUR_X550_10G_RJ45_PCIEx8_双        | 10G   | 2          |
|      | NIC_M_25G_MCX4121A-ACAT_LC_PCIEx8_2_XR   | 25G   | 2          |
|      | NIC_M_25G_MCX512A-ACAT_LC_PCIEx8_2_XR    | 25G   | 2          |
|      | NIC_BRCM_25G_57414_LC_PCIEx8_2_XR_42C    | 25G   | 2          |
|      | NIC_M_25G_MCX631102AN_LC_PCIEx8_2_XR     | 25G   | 2          |
|      | NIC_Inspur_Andes-M6_E810_25G_LC_PCIEx8_2 | 25G   | 2          |
|      | NIC_M_100G_MCX516A-CDAT_LC_PCIEx16_2P_XR | 100G  | 2          |
|      | NIC_M_100G_MCX623106AN_LC_PCIEx16_2_XR   | 100G  | 2          |



IMPORTANT

A server supports up to six NICs of the same type, six 1G/10G NICs of different types, or four 25G (or above) NICs. It also supports mixed use of NICs of different types.

## 7.8 FC HBA Card

Table 7-12 FC HBA Cards

| HBA Card | Qlogic | HBA_QL_4R1_QLE2690-ISR-BK_FC16G_PCIE |
|----------|--------|--------------------------------------|
|          | Emulex | N/A                                  |

## 7.9 HCA Card

Table 7-13 HCA Card

| Model & Description                      | Speed | Interfaces |
|--|-------|------------|
| HCA Card_M_1-HDR100_MCX653105A-ECAT_PCIE | 100G  | 1          |
| HCA_M_1-HDR200_MCX653105A-HDAT_PCIE      | 200G  | 1          |



### IMPORTANT

- To use HCA cards under Windows, install the IB driver downloaded from Mellanox official website first, and then install the Chipset driver
- PCIe x16 is required for a speed of over 100G.

## 7.10 Graphic Card & GPU

Table 7-14 Graphic Card

| Type | Model & Description              | Max. No. |
|------|----------------------------------|----------|
| GPU  | GPU_NV_32G_Tesla-V100S_4096b     | 4        |
|      | GPU_NV_40G_Tesla-A100-PCIe_5120b | 4        |
|      | GPU_NV_16G_Tesla-T4_256b         | 8        |
|      | GPU_NV_24G_NVIDIA-A10_384b       | 4        |
|      | GPU_NV_48G_A40-PCIe_384b         | 4        |



### IMPORTANT

The graphic card needs to be inserted into the PCIe x16 Riser slot.

## 7.11 Power Supply

The hot-swap PSUs, up to 2, meet Intel's CRPS standard, adopt general electrical and structural design, and support 1+1 redundancy (4-GPU configuration does not support redundancy). The PSUs supports tool-less installation and removal. Once inserted into the power bay, they will be locked in place automatically. A CRPS PSU is 80 PLUS Platinum rated, and offers various output powers, allowing customers to choose based on the actual configuration.

- The following rated 110V - 230V AC and 240V DC power supplies of 1+1 redundancy are supported:
  - 550W Platinum PSU: 550W (110VAC), 550W (230VAC), 550W (240VDC for China)
  - 800W Platinum PSU: 800W (110VAC), 800W (230VAC), 800W (240VDC for China)

- 1300W Platinum PSU: 1000W (110VAC), 1300W (230VAC), 1300W (240VDC for China)
- 1600W Platinum PSU: 1000W (110VAC), 1600 W (230VAC), 1600W (240VDC for China)
- 2000W Platinum PSU: 1000W (110VAC), 2000 W (230 VAC), 2000W (240VDC for China)
- 800W Titanium PSU: 800W (110VAC), 800W (230 VAC), 800W (240VDC for China)
- 1300W Titanium PSU: 1000W (110VAC), 1300W (230VAC), 1300W (240VDC for China)

**NOTE**

At a rated voltage of 110VAC, a 1300W or higher PSU will be derated to 1000W.

Input voltage range:

110VAC - 230VAC: 90V - 264V

240VDC: 180V - 320V

- The following rated 336 VDC PSU of 1+1 redundancy are supported:

800W 336VDC PSU: 800W (336VDC)

1300W 336VDC PSU: 1300W (336VDC)

Input voltage range:

336VDC: 260V - 400V

- The following rated -48VDC PSU of 1+1 redundancy are supported:

800W -48VDC PSU: 800W (-48VDC)

1300W -48VDC PSU: 1300W (-48VDC)

Input voltage range:

-48VDC: -40V to -72V

## 7.12 Operating System

Table 7-15 Operating Systems

| OS Manufacturer | OS Version             |
|-----------------|------------------------|
| Windows         | Windows Server 2019    |
| Red Hat         | Red Hat Enterprise 7.9 |
|                 | Red Hat Enterprise 7.8 |
|                 | Red Hat Enterprise 8.2 |
|                 | Red Hat Enterprise 8.3 |
| SUSE            | SUSE12 SP5             |
|                 | SUSE15 SP2             |
| Centos          | Centos_7.8             |
|                 | Centos_7.9             |
|                 | Centos_8.2             |
|                 | Centos_8.3             |
| ESXi 7          | Vmware Esxi_7.0        |
| Ubuntu18        | Ubuntu 18.04.05        |
| Ubuntu20        | Ubuntu 20.04           |

# 8 Configuration Notes

---

- YZMB-01642-101 high-end mainboard does not support LOM, and uses VR from IFX. It supports Mezz RAID, dual-BIOS redundancy, onboard TF cards, 4-GPU configuration, 4 internal drives, two 3.5'' drives and one OCP NIC on the rear panel.
- YZMB-01642-102 mainstream mainboard does not support LOM, and uses VR from TI. It supports Mezz RAID and one OCP NIC.
- YZMB-01642-103 mainstream mainboard does not support LOM, and uses VR from IFX. It supports Mezz Raid, dual-GPU configuration, 4 internal drives, two 3.5'' drives and one OCP NIC on the rear panel.
- YZMB-01642-104 mainstream mainboard supports LOM, and uses VR from TI. It supports Mezz Raid and one OCP NIC.
- YZMB-01642-105 mainstream mainboard supports LOM, and uses VR from IFX. It supports Mezz RAID and one OCP NIC.
- The YZMB-02244-101 14-layer mainboard supports Mezz Raid, dual-BIOS redundancy, onboard TF cards, 4-GPU configuration, 4 internal drives, two 3.5'' drives and one OCP NIC on the rear panel.
- The appropriate ambient temperatures for different configurations please see Table 6-3 Operating Temperature Specifications and the Note below.



# 9 System Management

## 9.1 Intelligent Management System ISBMC

ISBMC, a remote server management system developed in house by Inspur, supports such mainstream management specifications in the industry as IPMI 2.0 and Redfish 1.8. It features higher operational reliability and excellent serviceability for different customer scenarios. It provides comprehensive and accurate fault diagnosis capabilities and enhanced security above industry average.

It supports the following key features:

- IPMI 2.0
- Redfish 1.8
- Simple network management protocols (SNMP v1/v2c/v3)
- HTML5/Java remote consoles (keyboards, mouses, and videos)
- Remote virtual media
- Login on Web browsers
- Intelligent fault diagnosis

**Table 9-1 ISBMC Specifications**

| Specification                 | Description  |
|-------------------------------|--|
| Management Interface          | Supports extensive remote management interfaces and is applicable to various server O&M scenarios. The supported interfaces include: <ul style="list-style-type: none"> <li>• IPMI</li> <li>• SSH CLI</li> <li>• SNMP</li> <li>• HTTPS</li> <li>• Web GUI</li> <li>• Redfish</li> <li>• Restful</li> <li>• DCMI</li> <li>• Syslog</li> </ul> |
| Intelligent Fault Location    | With IDL, a fault diagnosis system developed in-house at Inspur, it provides comprehensive and accurate hardware fault location capabilities, and outputs detailed fault causes and handling suggestions.  |
| Alarm Management              | Supports rich automatic remote alarm capabilities, including SNMP Trap (v1/v2c/v3), email alarms, syslog remote alarms, and other proactive alarming mechanisms to ensure 24 × 7 reliability.  |
| Remote Console KVM            | Supports HTML5- and Java-based remote consoles, supports remotely taking over the display/mouse/keyboard of the server, and provides highly available remote management capabilities without on-site operations.   |
| Virtual Network Console (VNC) | Supports mainstream third-party VNC clients without relying on Java and improves management flexibility.   |

|   |  |
|---|--|
| Remote Virtual Media                              | Supports virtualizing local devices or mirrors, USB devices, and folders as media devices of remote servers, simplifying system installation, file sharing, and other O&M tasks.   |
| Web GUI   | Supports the visual management interface developed by Inspur, provides comprehensive display of server information and status, and offers an easy-to-use O&M panel.  |
| Downtime Screenshotting and Common Screenshotting | Supports automatic screenshotting during downtime to capture the last screen before the downtime, and provides the screenshotting function, which can quickly capture the screen to facilitate regular inspections.  |
| Dual Flash and Dual Mirroring                     | Supports dual flash and dual mirroring with automatic flash failover upon software faults or flash damage, improving operational reliability.  |
| Power Capping                                     | Supports power capping, increasing deployment density and reducing energy consumption.   |
| IPv4/IPv6   | Supports both IPv4 and IPv6, enhancing network deployment flexibility.   |
| Adaptation of Management Network Interfaces       | Supports adaptation of dedicated management network interfaces and network controller sideband interfaces (NC-SI), and provides customers with flexible network deployment solutions for different management network deployment scenarios.  |
| ISBMC Self-diagnosis and Self-recovery System     | Supports the reliable dual watchdog mechanism for hardware and software, enabling automatic restoration of abnormal programs to normal under extreme BMC situations.<br>Provides a heat dissipation protection mechanism, which is automatically triggered when a BMC program is abnormal to ensure that the fan operates at a safe speed to avoid overheating of the entire system.<br>Supports self-diagnosis of processors, memory modules, and storage devices of ISBMC, and automatically cleans up the workload and restores to normal when the device consumption rate is too high. |
| Power Supply Control                              | Supports virtual power buttons for startup, shutdown, restart, and shutdown and then restart.  |
| UID LED and Remote Control LED                    | Supports remote lighting of the unit identification (UID) LED for locating the server in the computer room, and supports remote control LED. The UID LED flashes when a user remotely logs in through the web, KVM, or SSH to inform the on-site personnel that an administrator is accessing the server.  |
| Secure Firmware Upgrade                           | Supports firmware upgrades based on secure digital signatures, unexpected upgrade prevention mechanism for different manufacturers and models, and firmware upgrades of BMC/BIOS/CPLD/PSU and other devices.   |
| Serial Port Redirection                           | Supports remote redirection of system serial ports, BMC serial ports, and other serial ports, and directs the server-side serial port output to the local administrator through the network for server debugging.  |
| Storage Information Viewing                       | Supports display of Raid logical array information and drive information, and remote RAID formation for improved deployment efficiency.  |
| User Role Management                              | Supports refined user management based on user roles and flexible creation of user roles with different permissions, and provides refined user roles to allow administrators to grant different permissions to O&M personnel.  |

|                   |   |
|-------------------|---|
| Security Features | Adopts the industry-leading Inspur server security baseline standard V2.0, and uses secure and reliable algorithms for SSH, HTTPS, SNMP, and IPMI, and has the capabilities including secure upgrade and boot as well as security reinforcement mechanisms such as anti-replay, anti-injection, and anti-brute force. |
|-------------------|---|

## 9.2 Inspur Physical Infrastructure Manager (ISPIM)

The NF5280M6 server is compatible with the latest version of Inspur Physical Infrastructure Manager (ISPIM).

ISPIM is a next-generation infrastructure O&M management platform for industry data centers. Based on cutting-edge O&M concepts, ISPIM provides users with leading and efficient overall management solutions for data centers to ensure the advancement of their infrastructure management. This platform provides a rich set of functions such as centralized resource management, in-depth fault diagnosis, real-time performance monitoring, intelligent energy consumption management, 3D automatic topology, and stateless automatic deployment. With these functions, users can implement central O&M of servers, storage devices, network devices, security devices, and edge devices, effectively improving O&M efficiency, reducing O&M costs, and ensuring the secure, reliable, and stable operation of data centers. ISPIM has the following key features:

- Lightweight deployment for multiple scenarios and full lifecycle management of devices
- High reliability and on-demand data collector for 1-N expansion
- Intelligent asset management and real-time tracking of asset changes
- Comprehensive monitoring for overall business control
- Intelligent fault diagnosis for reduced correction time
- Real-time performance monitoring for status control of devices
- Batch upgrade, configuration, and deployment for reduced launch time
- Version management for improved version management efficiency
- Standardized northbound interfaces for easy integration and interfacing

**Table 9-2 ISPIM Specifications**

| Specification                 | Description  |
|-------------------------------|--|
| Centralized Device Management | Supports centralized management of network-wide devices, including servers (covering the complete Inspur server family, including general rack-mounted servers, AI servers, blade servers, all-in-ones and other high-end server products, and third-party servers), storage devices (Inspur general disk arrays, distributed storage devices, and storage devices of other manufacturers), and network devices (Inspur switches, third-party switches, and third-party firewall devices). |
| Monitoring Management         | Supports centralized display, search, and blocking of device alarms, and email notifications, and supports the creation of alarm rules, notification rules, and blocking rules, alarm redefinition, alarm forwarding and southbound settings, device performance monitoring, and distributed monitoring.   |
| Stateless Computing           | Supports BMC/BIOS upgrade and configuration of Inspur servers, RAID configuration of Inspur servers, automatic hardware baseline management, and file repository upgrade.  |

|                             |   |
|-----------------------------|---|
| Operating System Deployment | Supports batch deployment of operating systems through the BMC interface, one-click deployment with automatic status writeback without manual intervention, and concurrent deployment of up to 40 devices.                        |
| Asset Management            | Supports part-level asset management, multi-dimensional asset statistics, 3D data centers, and asset maintenance management.  |
| Inspection Management       | Supports active inspection tasks, alarm-triggered passive inspection, intelligent fault diagnosis and analysis, and automatic fault reporting and correction.   |
| Security Management         | Implements security control of ISPIM by using a set of security policies such as user management, role management, authentication management (local authentication and LDAP authentication), and certificate management policies. |

### 9.3 Inspur Server Intelligent Boot (ISIB)

NF5280M6 is compatible with the latest Inspur Server Intelligent Boot (ISIB) system, an automatic O&M management system throughout the server lifecycle. Based on SSH and PXE technologies, it is compatible with the entire family of Inspur servers, and has more efficient and reliable automatic deployment and software and hardware configuration management functions. Its key features include:

- Full lifecycle device management from rack mounting to automatic O&M
- Bare-metal one-stop deployment with one-click racking
- Flexible task scheduling with O&M capabilities for different scenarios
- Large-scale deployment of technical architecture for reduced launch time
- Zero network deployment with plug-and-play support
- Accurate logging and instruction-level tracing of execution results
- Rich built-in O&M scripts and management schemes













**Table 9-3 ISIB Specifications**

| Specification | Description  |
|---------------|--|
| Home          | Provides multi-dimensional statistical results of assets, repositories, operations, and jobs, dynamic display of jobs in the last 24 hours, and histogram display of jobs in the last 30 days.   |
| Asset         | Supports automatic device discovery, operating system information collection, and out-of-band/in-band power supply management.   |
| Repository    | Provides the management of mirrors, software, firmware, configuration files, scripts, and sources to facilitate operations such as operating system deployment and firmware upgrades.  |
| Operation     | Supports firmware upgrades;<br>Supports hardware configuration;<br>Supports PXE automatic installation;<br>Supports installation template management;<br>Supports mirror cloning and restoration;<br>Supports software distribution;<br>Supports configuration changes;<br>Supports system inspection. |

|      |  |
|------|--|
| Task | Supports job scheduling, and scheduled and periodic task execution.<br>Provides visual multi-dimensional task display and refined log viewing. |
|------|--|

# 10 Certification

Product certifications obtained are as follows:

| Region        | Certification Program         | Certification Logo  |
|---------------|-------------------------------|---|
| China         | CCC                           |    |
|               | China Environmental Labelling |    |
|               | CECP                          |    |
| International | CB                            |    |
| EU            | CE                            |   |
| U.S.          | FCC                           |  |
|               | UL                            |  |
|               | Energy Star                   |  |
| Russia        | EAC                           |  |
|               | FSS                           | N/A   |
| South Korea   | E-Standby                     |  |
|               | KC                            |  |
| India         | BIS                           |  |
| Australia     | RCM                           |  |

---

# 11 Service Terms

---

Please visit Inspur official Website at <https://en.inspur.com/>, click **Support > Support Center > Warranty & Configuration**, and enter the product model, part model, serial number or keywords to learn relevant information and check the warranty status and configuration of related product.

- Global service hotline:
  - 1-844-860-0011 (toll free)
  - 1-760-769-1847 (direct line)
  - Service email: serversupport@inspur.com
  
- Information required from customers:
  - Name
  - Company information
  - Contact number
  - Email address
  - Product model
  - Product serial number
  - Problem description

# 12 Relevant Documents

---

For more information, go and visit <https://en.inspur.com>, where you can find resources to help customers solve problems and learn about our products, such as product manuals, drivers, and firmware.



# 13 Trademark

---

Inspur and Inspur logos are owned by Inspur Group Co., Ltd. All other trademarks and trade names mentioned in this document are the properties of their respective owners.